

ClearOne

MAX™ EX

INSTALLATION & OPERATION MANUAL



MAX EX INSTALLATION & OPERATION MANUAL

CLEARONE PART NO. 800-158-015 SEPTEMBER 2007 (REV 4.0)

U.S. PATENT NO. D499,392. OTHER PATENTS PENDING.

© 2007 ClearOne Communications, Inc. All rights reserved. No part of this document may be reproduced in any form or by any means without written permission from ClearOne Communications. ClearOne Communications reserves specific privileges. Information in this document is subject to change without notice.

TABLE OF CONTENTS

CHAPTER 1: INTRODUCTION	1
Service and Support	1
Product Returns	1
Unpacking	2
Important Safety Information	2
CHAPTER 2: GETTING STARTED	4
Connecting MAX EX to an Analog Phone Line	4
Connecting MAX EX Expansion Pods	4
Connecting MAX EX to a Digital (PBX) Phone Line	5
Using your MAX EX Phone	6
CHAPTER 3: USER OPTIONS	8
Calling Features	8
Programming Features	9
Alert Tones	11
CHAPTER 4: MAINTENANCE	12
Caring for MAX EX Phones	12
Electrical Considerations	12
Troubleshooting	12
CHAPTER 5: APPENDIX	14
Specifications	14
Compliance	15
Warranty	18

CHAPTER 1: INTRODUCTION

Thank you for purchasing the ClearOne MAX™ EX expandable conferencing phone. MAX EX provides premium, full-duplex audio to small conference rooms as a single unit, and to larger rooms by connecting up to four MAX EX units together. Connecting MAX EX units together allows you to expand microphone and speaker coverage, as well as control access, for a more natural communications experience in larger rooms.

Setting up the MAX EX conferencing phone is easy and requires only three connections: power, telephone, and base unit to conference pod. MAX EX's familiar keypad design ensures users will be comfortable using the phone, reducing the need for training and support.



Max EX offers these key advantages:

- **Expandability:** MAX EX is ideal for conference rooms because it provides flexible microphone and loudspeaker coverage, and easy access to controls, simply by linking units together to match room size.
- **Superior Audio Quality:** MAX EX delivers industry-leading, crystal-clear audio that facilitates more natural interactions among conference participants.
- **Easy to Use:** The MAX EX controls are intuitive, user friendly, and simple to operate.

SERVICE AND SUPPORT

If you need additional information on how to set up or operate your MAX EX conferencing phone, please contact us. We welcome and encourage your comments so that we can continue to improve our products and serve your needs.

Technical Support

Telephone: 1-800-283-5936 (USA) or
1-801-974-3760
Fax: 1-801-977-0087
E-mail: tech.support@clearone.com
Web: www.clearone.com

Sales and Customer Service

Telephone: 1-800-945-7730 (USA) or
1-801-975-7200
Fax: 1-800-933-5107 (USA) or
1-801-977-0087
E-mail: sales@clearone.com

PRODUCT RETURNS

All product returns require a return materials authorization (RMA) number. Please contact ClearOne Technical Support before attempting to return your product. Make sure you return all the items that shipped with your product.

UNPACKING

Ensure you have received all items shown below for your MAX EX model (MAX EX and MAX Expansion Kit). After unpacking, place the MAX EX Conferencing Pod and Base Unit on a level surface.

MAX EX Package Contents

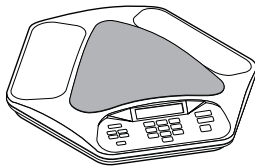

Conferencing Pod

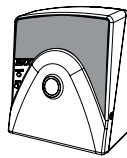

Base Unit

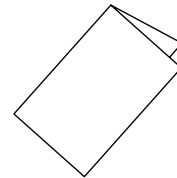

Quick Start Guide



25' CAT-5 Cable

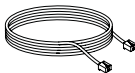

Telephone Cable

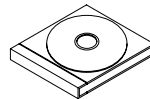

Documentation CD



Power Cable

MAX EX Expansion Kit Package Contents

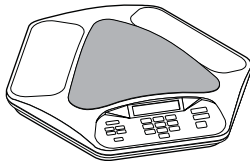

Conferencing Pod



12' CAT-5 Cable

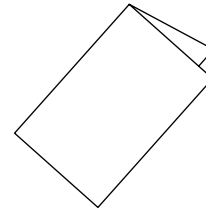

Quick Start Guide

IMPORTANT SAFETY INFORMATION

Read the safety instructions before using this product. This conferencing phone is not designed for making emergency telephone calls when the power fails. Make alternative arrangements for access to emergency services.

- Read and understand all instructions.
- Follow all warnings and instructions marked on the product.
- Unplug this product from the wall outlet before cleaning. Use a damp cloth for cleaning. Do not use liquid cleaners or aerosol cleaners.
- Do not use this product near water, including bathtubs, sinks, or near a swimming pool.
- Do not place this product on an unstable cart, stand, or table.
- Slots and openings in the back or bottom of the product are provided for ventilation. To prevent overheating, these openings must not be blocked or covered.
- This product should never be placed near or over a radiator or heat register. This product should not be used in built-in installations unless proper ventilation is provided.



- This product should be operated only from the type of power source indicated on the marking label. If you are not sure of the type of power supply in your location, consult your dealer or local power company.
- Do not overload wall outlets and extension cords as this can result in the risk of fire or electric shock.
- Never push objects of any kind into this product through cabinet slots as they may touch dangerous voltage points or short out parts that could result in fire or electric shock.
- Never spill liquids on the product.
- To reduce the risk of electric shock, do not disassemble this product. Opening or removing covers may expose you to dangerous voltages or other risks. Incorrect reassembly can cause electric shock during subsequent use.
- Unplug this product from the wall outlet and battery source and refer servicing to qualified service personnel under the following conditions:
 - » When the power supply cord or plug is damaged or frayed.
 - » If liquid has been spilled into the product.
 - » If the product does not operate normally according to the operating instructions.
 - » If the product has been dropped or damaged.
 - » If the product exhibits a distinct change in performance.
- Do not use this product or other phones during an electrical storm. There is a remote risk of electric shock from lightning.
- Do not use this product to report a gas leak in the vicinity of the leak.
- Do not use this product near intensive care medical equipment or by persons with pacemakers.
- Due to the radio signals between base station and POD, wearers of hearing aids may experience interference in the form of a humming noise.
- This product can interfere with electrical equipment such as answering machines, TV sets, radios, computers and microwave ovens if placed too close.

Telephone Wiring and Jack Information

To reduce the risk of fire or injury to persons, read and follow these instructions:

- Use caution when installing or modifying telephone lines.
- Never install telephone wiring during an electrical storm.
- Never install telephone jacks in wet locations unless the jack is specifically designed for wet locations.
- Never touch un-insulated telephone wires or terminals unless the telephone line is disconnected at the network interface.

WARNING: TO PREVENT FIRE OR ELECTRICAL SHOCK HAZARD, DO NOT EXPOSE THIS PRODUCT TO RAIN OR MOISTURE.

	CAUTION RISK OF ELECTRIC SHOCK DO NOT OPEN	
THE LIGHTNING FLASH AND ARROW HEAD WITHIN THE TRIANGLE IS A WARNING SIGN ALERTING YOU OF DANGEROUS VOLTAGE INSIDE THE PRODUCT	CAUTION: TO REDUCE THE RISK OF ELECTRIC SHOCK, DO NOT REMOVE COVER (OR BACK) NO USER SERVICEABLE PARTS INSIDE. REFER SERVICING TO QUALIFIED SERVICE PERSONNEL.	THE EXCLAMATION POINT WITHIN THE TRIANGLE IS A WARNING SIGN ALERTING YOU OF IMPORTANT INSTRUCTIONS ACCOMPANYING THE PRODUCT.
SEE MARKING ON BOTTOM / BACK OF PRODUCT		

Save These Instructions

CHAPTER 2 : GETTING STARTED

CONNECTING MAX EX TO AN ANALOG PHONE LINE

Connecting MAX EX

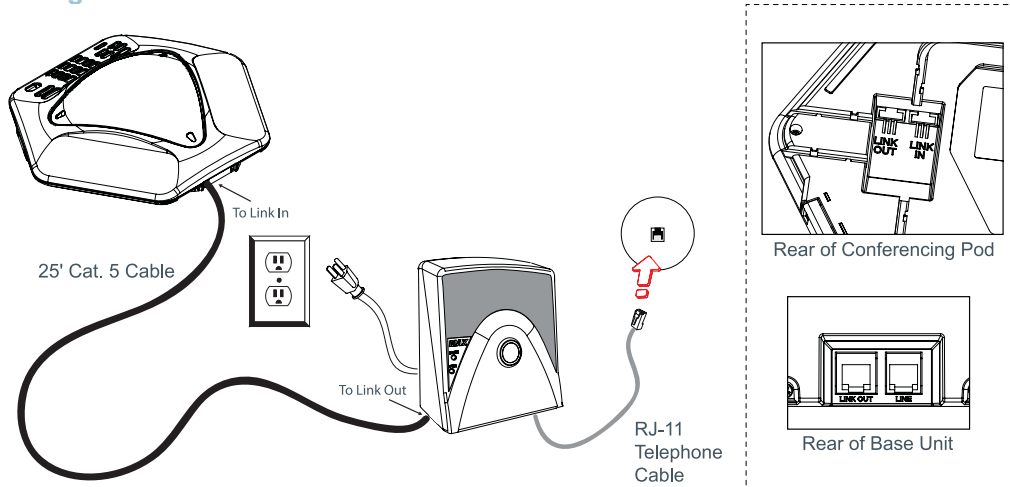

1. Connect the Link Out jack on the base unit to the Link In jack on the conferencing pod using the CAT-5 cable.
2. Connect the base unit to the telephone jack using the RJ-11 telephone cable.
3. Connect the power cord to the base unit and plug it directly into an electrical outlet.

Connecting MAX EX Expansion Pods

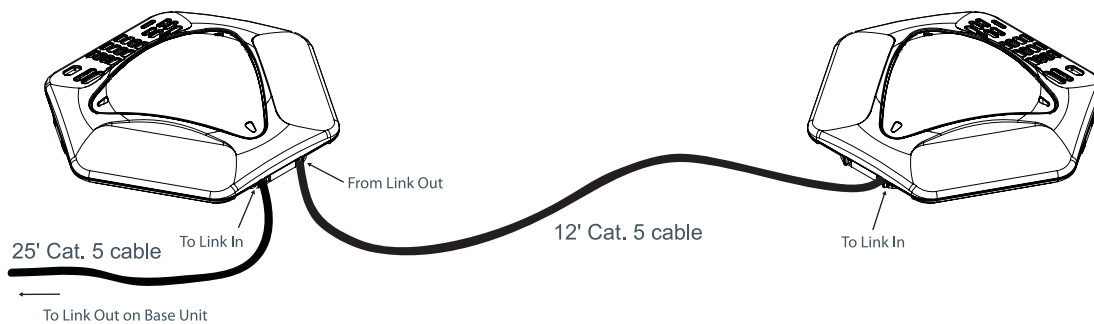

1. Connect the 12' Cat. 5 cable to the Link Out jack on the first phone and the Link In jack on the second phone.
2. Continue linking up to three additional MAX EX phones in the same fashion. A total of four units may be connected.

CONNECTING MAX EX TO A DIGITAL (PBX) PHONE LINE

MAX EX phones can be connected to a PBX by using a digital-to-analog converter. To connect a MAX EX phone to a digital (PBX) line, use the following diagram and procedure:

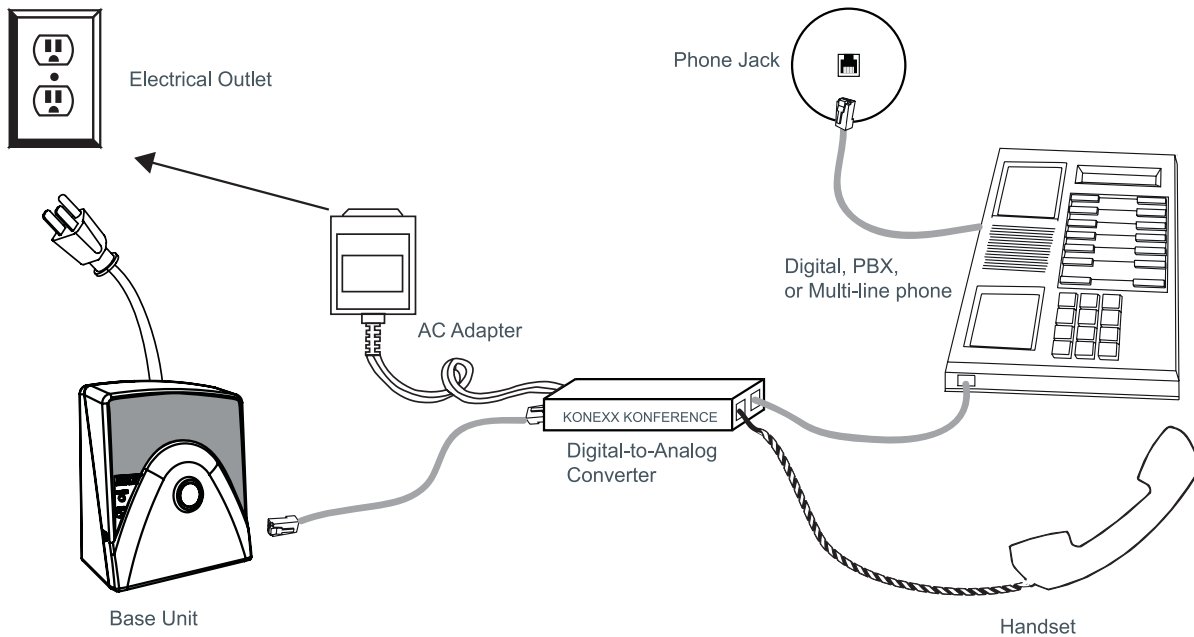

1. Connect the telephone cable to the phone jack on the back of the base unit, and the other end into the digital-to-analog converter.
2. Connect the converter's AC power adapter to an electrical outlet.
3. Connect a second telephone cable from the converter to a digital or PBX phone. Consult the converter's user manual for more information.
4. Connect the power cable to the base unit and plug it into an AC outlet.

NOTE: Do not connect the MAX EX phone directly to a digital (PBX) line without using a digital-to-analog telephone line converter. Permanent damage may result. For assistance, contact ClearOne technical support.

USING YOUR MAX EX PHONE

To Make a Call

1. Press the **ON/OFF** key. You hear a dial tone.
2. Dial the number as you would on a standard phone. The number is displayed on the LCD screen.

NOTE: You can also pre-dial the number while in standby (inactive) mode and press the **ON/OFF** key to connect the call. Press and hold the pound key (#) to enter a pause in the dialing string.

To Answer a Call

1. Press any key (except the star "*" key, MUTE, VOLUME UP or VOLUME DOWN) on the keypad to answer the call.
2. When there is an incoming call, the phone rings and the LEDs on the phone and the phone icon on the LCD screen flash (as shown below).

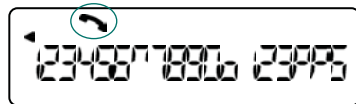

Phone active icon

To End a Call

1. Press the **ON/OFF** key. This disconnects the call and returns the phone to standby mode.

To Redial a Number

1. Press the **ON/OFF** key. You will hear a dial tone.
2. Press **REDIAL** to dial the last number called.

NOTE: You can also press **REDIAL** while in Standby mode to display the last number called. To connect the call, press the **ON/OFF** key.

To Adjust Ringer Volume

- While the phone is ringing, press **VOLUME UP** or **VOLUME DOWN**.
- While the phone is inactive, press **VOLUME UP** or **VOLUME DOWN**. The ringer melody will play once at the new level.

To Mute a Call

- Press **MUTE** to mute the call.
- Press **MUTE** again to un-mute the call.

To Make a Call Using the Phonebook

1. Press the **ON/OFF** key. You will hear a dial tone.
2. Press **PHONEBOOK**.
3. Press the number key (**0-9**) that corresponds with the location of the stored phone number you want to dial. This feature must be programmed before use. See *Programming Features* for additional information.

To Store a Number In the Phonebook

1. Enter the phone number you want to store while conferencing POD is in standby mode.
2. Press and hold the **PHONEBOOK/EDIT** key until the phonebook and program icons appear on the LCD screen (as shown below).

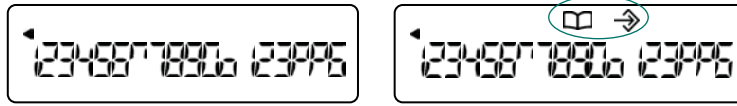

The Phonebook and Program icons.

Adding Phonebook Entries

1. Assign a phonebook location (**0-9**) by pressing the corresponding number key.
2. Press **PHONEBOOK** again to save the entry. You will hear a confirmation tone.
3. Press **CLEAR** to exit phonebook edit mode before saving the entry.

NOTE: Press and hold the **1** numeric key to enter a hyphen or the ***** key to enter a space in the number. Press **CLEAR** to delete the old number before entering a new number.

To Access a Speed Dial Number

- Press the **SPEED DIAL** key. This feature must be programmed before use. See *Programming Features* for additional information.

To Access Your Service Center

- While in standby mode, press and hold the **0** key for 2 seconds. This feature must be programmed before use. See *Programming Features* for additional information.

CHAPTER 3 : USER OPTIONS

CALLING FEATURES

In addition to the basic phone operations described in the previous chapter, you can use calling features to perform any of the following functions during a call:

- Change to Pulse Dialing
- Send a Flash Signal
- Display a Phone Number
- Adjust Speaker Volume
- Turn the Ringer On/Off.

These functions are described in the following sections.

To Use Pulse Dialing

MAX EX uses tone dialing by default. You can temporarily change to pulse dialing during a call.

- Press the star (*) key. A special character will appear. All numbers entered after this character will use pulse dialing. When the call is finished, the dialing mode automatically reverts to tone dialing.

NOTE: When more than 18 characters are entered, a scroll button will appear on the LCD display, and the numbers will scroll from right to left.

To Send a Flash Signal

If your telephone service includes call transfer, call waiting, conference calling, or other carrier features, use the flash key to activate the feature. Refer to your local telephone service provider for details.

To Display Your Local Number During a Call

- Press **CLEAR**. The phone number will appear. After several seconds, the call timer will return.

To Adjust Speaker Volume

- Press the **VOLUME UP** key while on a call to increase volume.
- Press the **VOLUME DOWN** key while on a call to decrease volume.

To Turn the Ringer On/Off

- Press and hold the star (*) key. The ringer off icon illuminates when ringer is turned off (as shown below).

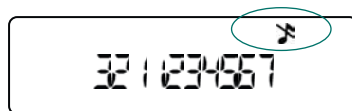

Ringer off icon

To Mute During Ringing

- Press the star (*) or the **MUTE** key to mute the ringer until the incoming call terminates.

PROGRAMMING FEATURES

To allow for individual preferences and enhanced usability, MAX EX provides the following programmable features:

- Ringer Melody
- Dialing Mode
- Flash Duration
- Local Phone Number
- Speed Dial Numbers
- Service Center Number
- AGC/ALC (Automatic Gain Control/Automatic Level Control)

You may also restore factory defaults. The following sections describe how to program these features.

Entering Programming Mode

1. Press and hold the **REDIAL/PROG** key until the program icon appears on the LCD screen (as shown below).

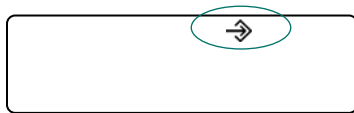

Programming mode icon

To Change Ringer Melody

1. Press the **1** numeric key to enter the ringer melody menu. There are five available melodies.
2. Press **REDIAL/PROG**. The current melody selection will flash.
3. Press numeric keys **1–5** to play the corresponding melody. The selected melody will play once.
4. Press **REDIAL/PROG** to save the selection.
5. Press **CLEAR** to exit programming mode.

To Change Dialing Mode

1. Press and hold the **REDIAL/PROG** key until the program icon appears on the LCD screen.
2. Press the **2** numeric key to enter the dialing mode menu. There are two dialing modes: tone and pulse. The current dialing mode will be displayed (T for tone, P for pulse).
3. Press **REDIAL/PROG**. The current mode will flash.
4. Press the **1** numeric key to select tone dialing, or **2** to select pulse dialing.
5. Press **REDIAL/PROG** to save the selection.
6. Press **CLEAR** to exit programming mode.

To Change the Flash Duration

1. Press and hold the **REDIAL/PROG** key until the program icon appears on the LCD screen.
2. Press the **3** numeric key to enter the flash duration menu. The current duration will be displayed in milliseconds. There are five duration settings: 600, 300, 150, 100 and 80.
3. Press **REDIAL/PROG**. The current duration will flash.
4. Press the **1–5** numeric keys to select a new duration setting.
5. Press **REDIAL/PROG** to save the selection.
6. Press **CLEAR** to exit programming mode.

To Program a Local Phone Number

1. Press and hold **REDIAL/PROG** until the program icon appears on the LCD screen.
2. Press the **4** numeric key to enter the user phone number menu.
3. Press **REDIAL/PROG**.
4. Enter the local phone number.
5. Press **REDIAL/PROG** to save the number.
6. Press **CLEAR** to exit programming mode.

NOTE: Press and hold the **1** numeric key to enter a hyphen. Press the ***** key to enter a space in the number. Use **CLEAR** to delete the old number before entering a new number.

To Program a Speed Dial Number

1. Press and hold **REDIAL/PROG** until the program icon appears on the LCD screen.
2. Press the **5** numeric key to enter the speed dial menu.
3. Press **REDIAL/PROG**.
4. Enter the phone number.
5. Press **REDIAL/PROG** to save the number.
6. Press **CLEAR** to exit programming mode.

NOTE: Press & hold the **1** numeric key to enter a hyphen or the ***** key to enter a space in the number. Use **CLEAR** to delete the old number before entering a new number.

To Program the Service Center Number

1. Press and hold the **REDIAL/PROG** key until the program icon appears on the LCD screen.
2. Press the **6** numeric key to enter the service center menu.
3. Press **REDIAL/PROG**.
4. Enter the number you want MAX EX to dial when the **0** numeric key is pressed.
5. Press **REDIAL/PROG** to save the number.
6. Press **CLEAR** to exit programming mode.

NOTE: Press & hold the **1** numeric key to enter a hyphen or the ***** key to enter a space in the number. Use **CLEAR** to delete the old number before entering a new number.

To Program the Country Setting

1. Press and hold the **REDIAL/PROG** key until the program icon appears on the LCD screen.
2. Press **7** to enter the service center menu.
3. Press **REDIAL/PROG**.
4. Press the number key that corresponds with desired country from the table below.

1 = US/Canada/China/Japan/ Mexico/Singapore	4 = South Africa 5 = Brazil
2 = Europe CTR21	6 = New Zealand
3 = Australia	7 = South Korea

5. Press **REDIAL/PROG** to save the country setting, then press **CLEAR** to exit.

To Restore Factory Defaults

1. Press and hold the **REDIAL/PROG** key until the program icon appears on the LCD screen.
2. Press and hold the **9** numeric key. The number **8** appears across the LCD screen.
3. Press **REDIAL/PROG** to confirm the selection.
4. Press **CLEAR** to exit programming mode.

To Program Automatic Gain Control (AGC) and Automatic Level Control (ALC)

1. Press and hold the **REDIAL/PROG** key until the program icon appears on the LCD screen.
2. Press and hold the **8** numeric key. The current AGC setting number appears on the LCD screen.
3. Press **REDIAL/PROG**. The current setting number flashes.
4. Enter a new setting number using the AGC/ALC table shown below.

Setting	Speaker AGC	Microphone ALC
1	On	On
2	On	Off
3	Off	On
4	Off	Off

5. Press **REDIAL/PROG** to confirm selection.
6. Press **CLEAR** to exit programming mode.

ALERT TONES

The table below describes alert tones used by MAX EX.

Tone/Alert	Description
Not Powered	If the base unit is not powered, you will hear a beeping sound when you press the ON/OFF key.
Confirmation	A tone will play upon successful programming entry.
Reject	A tone will play if you attempt to do any of the following: <ul style="list-style-type: none">• enter an invalid programming entry;• use a speed dial key that has not been programmed with a speed dial number or service center number;• enter a 45th digit when predialing;• enter a 17th digit for a phone number;• enter a 31st digit for a speed dial key when entering a speed dial number or service center number.
Low Battery	An alert will sound every 60 seconds when the battery pack requires charging and POD is in phone mode.
Out of Range	An alert will sound every 30 seconds when the POD is too far from base unit and the system is in phone mode.
Paging	When the PAGE button on the base unit is pressed, the POD will beep loudly for 30 seconds, or until any key on the keypad is pressed.

CHAPTER 4 : MAINTENANCE

CARING FOR MAX EX PHONES

- Follow all warnings and instructions marked on your MAX EX phone.
- Unplug base unit and conferencing pod from the wall outlet before cleaning.
- Use a damp cloth moistened with water to clean the outside of your conferencing pod or base unit and power supply. Do not use liquid or aerosol cleaners.

ELECTRICAL CONSIDERATIONS

- Use only the power adapter that comes with your conferencing phone.

TROUBLESHOOTING

If you are having trouble with your MAX EX, it might be configured or connected incorrectly, or other equipment might be causing the malfunction. Use the following checklist and the chart on the following page to troubleshoot malfunctions.

Connection Checklist

- The MAX EX base unit is plugged into the proper volt electrical outlet and its power light is on.
- The telephone cord from the base unit is securely connected to the telephone wall jack.
- The equipment the other party is using should be of comparable quality to your MAX EX conferencing phone. While MAX EX will work with lower-quality products, the quality of the conference call will be impacted if the party you are conferencing with has poor quality equipment.

Troubleshooting Table

Use the table on the following page to troubleshoot your MAX EX system.

If You Hear	It Could Be That	Try This
Beeping Sound Before Dialing	<p>POD is out of range</p> <p>Base unit is not powered.</p>	<p>Move pod section closer to the base unit.</p> <p>Make sure base unit is plugged into a power outlet and the Power LED is lit.</p>
No Dial Tone	<p>Base unit is not connected to a telephone jack.</p> <p>You are not using an analog phone line.</p>	<p>Connect the base unit to a telephone jack using the supplied telephone cable.</p> <p>Verify that you are using an analog phone line. Consult your IT department for help.</p>
Static or Noise	<p>You have a bad telephone connection.</p> <p>You have a bad telephone line.</p> <p>The other party's room is too noisy.</p>	<p>Place the call again to see if another line provides a better connection.</p> <p>Plug a working phone into the phone jack. If the line is still noisy, contact your telephone company.</p> <p>Ask the other party to turn off noisy equipment.</p>
Calls Come In, But You Can't Dial Out.	The dialing mode (tone or pulse) is set incorrectly for your service.	See <i>Calling Features</i> in this manual for instructions on changing the dialing mode.
Poor Audio Quality	<p>Building construction is limiting phone range.</p> <p>The equipment on the far end is of lesser quality.</p>	<p>Move base unit closer to the phone.</p> <p>The equipment should be upgraded. Participants can try sitting closer to equipment and eliminating background noises.</p>

APPENDIX

SPECIFICATIONS

Dimensions (W X D X H)

Phone section: 10.5" x 10.5" x 3"
(26.7 cm x 26.7 cm x 7.6 cm)
Base unit: 4.25" x 5.5" x 2.5"
(10.8 cm x 14 cm x 6.4 cm)

Weight

Phone section: 2.7 lb (1.2 kg)
Base unit: .6 lb (0.27 kg)
Shipping: 10 lb (4.5 kg)

Environmental

Operating Temperature: 0–48° C
(32–118° F)
Storage temperature: 5–70° C
(41–158° F)
Operating Humidity: 15 to 80%
Storage humidity: 10 to 90%

Power

Base Unit:
Auto-adjusting power module;
100–240VAC; 50/60 Hz

Telephone Connection

Analog PBX or PSTN line
RJ-11C/CA11A, –12dBm nominal

Keypad

Alphanumeric standard keypad

Loudspeaker Volume

90 dBspl A weighted @ 1 ft
Bandwidth: 200Hz - 3.3kHz

Record Output

Connector: 2.5 mm mono audio
jack
Impedance: <1000 ohm
Bandwidth: 200Hz–3.3kHz
Dynamic Range: 60dB
THD <.01%

Echo Cancellation

Tail Time: 128 mS x 3

Noise Cancellation

Dynamic Noise Cancellation

Certifications

FCC Part 15/ICES-003 Class A
FCC Part 68/IC CS-03
CE
UL, C-UL Certified

Warranty

2 Years

Models

MAX EX*
MAX EX Expansion Kit*

*Call your sales representative for part numbers, or visit
www.clearone.com

COMPLIANCE

FCC Part 15/ICES-003 Compliance

This equipment has been tested and found to comply with the limits for a Class A digital device, pursuant to Part 15 of the FCC rules and Industry Canada ICES-003. These limits are designed to provide reasonable protection against harmful interference when the equipment is operated in a commercial environment. This equipment generates, uses, and can radiate radio frequency energy and, if not installed and used in accordance with the instruction manual, may cause harmful interference to radio communications. Operation of this equipment in a residential area is likely to cause harmful interference, in which case the user will be required to correct the interference at his/her own expense.

Operation is subject to the following two conditions: (1) This device may not cause interference, and (2) This device must accept any interference including interference that may cause undesired operation of the device.

Changes or modifications not expressly approved by ClearOne Communications could void the user's authority to operate the equipment.

FCC Part 68 Compliance

US:FBIMT01B910158015 Ringer Equivalence Number (REN): 0.1B(ac)

This equipment complies with Part 68 of FCC Rules and Technical Requirements for Telephone Terminal Equipment published by ACTA. The marking on the base unit of this equipment contains, among other information, the US number and ringer Equivalence Number (REN) for this equipment. If requested, this information must be provided to your telephone company.

The REN is used to determine the quantity of devices, which may be connected to the telephone line. Excessive RENs on the telephone line may result in the devices not ringing in response to an incoming call. In most, but not all areas, the sum of the RENs should not exceed five (5.0). To be certain of the number of devices that may be connected to the line, as determined by the total RENs, contact the telephone company to obtain the maximum RENs for the calling area.

If this equipment causes harm to the telephone network, the telephone company will notify you in advance that temporary discontinuance of service may be required. If advance notice is not practical, the telephone company will notify the customer as soon as possible. Also, you will be advised of your right to file a complaint with the FCC if you believe it is necessary.

The telephone company may make changes in its facilities, equipment, operations, or procedures that could affect the operation of the equipment. If this happens, the telephone company will provide advance notice for you to make the necessary modifications in order to maintain uninterrupted service.

Notice

A plug and jack used to connect this equipment to the premises wiring and telephone network must comply with the applicable FCC Part 68 Rules and Requirements adopted by the ACTA. A compliant telephone cord and modular plug is provided with this product. It is designed to be connected to a compatible modular jack that is also compliant. See installation instructions for details.

If you experience problems with this equipment, contact ClearOne Communications, 5225 Wiley Post Way, Salt Lake City, Utah 84116, or by phone at (801) 975-7200 for repair and warranty information. If the trouble is causing harm to the telephone network, the telephone company may request you remove the equipment from the network until the problem is resolved.

No user serviceable parts are contained in this product. If damage or malfunction occurs, contact ClearOne Communications for instructions on its repair or return.

This equipment cannot be used on telephone company provided coin service. Connection to Party Line Service is subject to state tariffs.

IC Compliance

IC: 1970A-158015

Ringer Equivalence Number (REN): 0.1B(ac)

Notice

The term "IC" before the certification/registration number signifies that Industry of Canada technical specifications were met.

This certification means that the equipment meets certain telecommunications network protective operational and safety requirements. The Department does not guarantee the equipment will operate to the user's satisfaction.

The REN is used to determine the quantity of devices, which may be connected to the telephone line. Excessive RENs on the telephone line may result in the devices not ringing in response to an incoming call. In most, but not all areas, the sum of the RENs should not exceed five (5.0). To be certain of the number of devices that may be connected to the line, as determined by the total RENs, contact the telephone company to obtain the maximum RENs for the calling area.

Before installing this equipment, users should ensure that it is permissible to be connected to the facilities of the local telecommunications company. The equipment must also be installed using an acceptable method of connection. In some cases, the companies inside wiring associated with a single line individual service may be extended by means of a certified connector assembly (telephone extension cord). The customer should be aware that compliance with the above conditions may not prevent degradation of service in some situations.

Repairs to certified equipment should be made by an authorized Canadian maintenance facility designated by ClearOne Communications. Any repairs or alterations made by the user to this equipment, or equipment malfunctions, may give the telecommunications company cause to request the user to disconnect the equipment.

Users should ensure for their own protection that the electrical ground connections of the power utility, telephone lines and internal metallic water pipe system, if present, are connected together. This precaution may be particularly important in rural areas.

Waste Electrical and Electronic Equipment "WEEE Directive 2002/95/EC":

ClearOne is compliant with the WEEE directive. For recovery and recycling information by country, visit our website: www.clearone.com/support/recycling.php?content=main

European Compliance

Conformity of the equipment with the guidelines below is attested by the CE mark.



EC Declaration of Conformity

Manufacturer's Name:	ClearOne Communications
Manufacturer's Address:	Edgewater Corporate Park South Tower 5225 Wiley Post Way, Suite 500 Salt Lake City, Utah 84116 U.S.A.
EU Representative Name:	ClearOne Communications Ltd.
EU Representative Address:	Atlantic House Imperial Way Reading Berkshire RG2 0TD United Kingdom
Model:	MAX EX, MAX EX Expansion Kit.

Product Standard(s) to which Conformity of the Council Directive(s) is declared:

EMC - 2004/108/EC “Electromagnetic Compatibility (EMC) Directive”:

EN 55022: 2006 (Emissions)	Information technology equipment - Radio disturbance characteristics - Limits and methods of measurement.
EN 61000-3-2: 2004	Part 3: Limits - Section 2: Limits for harmonic current emissions.
EN 61000-3-3: 2002	Section 3: Limitation of voltage fluctuations and flicker in low voltage supply systems for equipment with rated current up to and including 16 A.
EN 55024: 1998 (Immunity) + A1+A2	Information technology equipment - Immunity characteristics -Limits and methods of measurements.
EN 61000-4-2: 2001	Electrostatic Discharge Immunity
EN 61000-4-3: 2002	Radiated RF Immunity
EN 61000-4-4: 2004	Electrical Fast Transients Immunity
EN 61000-4-5: 2005	Lightning Surge Immunity
EN 61000-4-6: 2004	Conducted RF Immunity
EN 61000-4-8: 1993	Power Frequency Magnetic Field Immunity
EN 61000-4-11: 2004	Voltage Dips and Voltage Interruptions

Safety - 73/23/EEC “Low Voltage Directive (LVD)”:

IEC 60950-1: 2001

Safety of Information Technology Equipment, Including Electrical Business Equipment.

Telecom - 1999/5/EC Radio equipment and Telecommunications Terminal Equipment (R&TTE) Directive:

ETSI ES 203 021 - 1, 2 and 3

Access and Terminals (AT); Harmonized basic attachment requirements for Terminals for connection to analogue interfaces of the Telephone Networks; Update of the technical contents of TBR 021, EN 301 437, TBR 015, TBR 017; Part 1: General aspects, Part 2: Basic transmission and protection of the network from harm, Part 3: Basic Interworking with the Public Telephone Networks.

Radio Equipment:

EN 300 328 V1.6.1 (2004-11)

Electromagnetic compatibility and Radio spectrum Matters (ERM); Wideband transmission systems; Data transmission equipment operating in the 2,4 GHz ISM band and using wide band modulation techniques; Harmonized EN covering essential requirements under article 3.2 of the R&TTE Directive.

RoHS - 2002/95/EC Restriction of the Use of certain Hazardous Substances in Electrical and Electronic Equipment (EEE) & WEEE - 2002/96/EC Waste of Electrical and Electronic Equipment (EEE).

We herein certify that the products listed above are in compliance with the EU directive 2002/95/EC and EU directive 2002/96/EC.

We, the undersigned, hereby declare that the equipment specified above conforms to the above directives and standards. Date of Issue: August 31, 2007

Manufacturer



Signature

Tracy Bathurst
Chief Technology Officer

Legal Representative in Europe



Signature

Martin Offwood
Managing Director - EMEA North