

Yealink



Yealink DECT Desk Phone User Guide

Version 82.40
Apr. 2018

Copyright

Copyright © 2018 YEALINK(XIAMEN) NETWORK TECHNOLOGY CO., LTD.

Copyright © 2018 Yealink(Xiamen) Network Technology CO., LTD. All rights reserved. No parts of this publication may be reproduced or transmitted in any form or by any means, electronic or mechanical, photocopying, recording, or otherwise, for any purpose, without the express written permission of Yealink(Xiamen) Network Technology CO., LTD. Under the law, reproducing includes translating into another language or format.

When this publication is made available on media, Yealink(Xiamen) Network Technology CO., LTD. gives its consent to downloading and printing copies of the content provided in this file only for private use but not for redistribution. No parts of this publication may be subject to alteration, modification or commercial use. Yealink(Xiamen) Network Technology CO., LTD. will not be liable for any damages arising from use of an illegally modified or altered publication.

Trademarks

Yealink®, the logo and the name and marks is trademark of Yealink (Xiamen) Network Technology CO., LTD, which are registered legally in China, the United States, EU (European Union) and other countries.

All other trademarks belong to their respective owners. Without Yealink's express written permission, recipient shall not reproduce or transmit any portion hereof in any form or by any means, with any purpose other than personal use.

Warranty

(1) Warranty

THE SPECIFICATIONS AND INFORMATION REGARDING THE PRODUCTS IN THIS GUIDE ARE SUBJECT TO CHANGE WITHOUT NOTICE. ALL STATEMENTS, INFORMATION, AND RECOMMENDATIONS IN THIS GUIDE ARE BELIEVED TO BE ACCURATE AND PRESENTED WITHOUT WARRANTY OF ANY KIND, EXPRESS OR IMPLIED. USERS MUST TAKE FULL RESPONSIBILITY FOR THEIR APPLICATION OF PRODUCTS.

(2) Disclaimer

YEALINK (XIAMEN) NETWORK TECHNOLOGY CO., LTD. MAKES NO WARRANTY OF ANY KIND WITH REGARD TO THIS GUIDE, INCLUDING, BUT NOT LIMITED TO, THE IMPLIED WARRANTIES OF MERCHANTABILITY AND FITNESS FOR A PARTICULAR PURPOSE. Yealink (Xiamen) Network Technology CO., LTD. shall not be liable for errors contained herein nor for incidental or consequential damages in connection with the furnishing, performance, or use of this guide.

(3) Limitation of Liability

Yealink and/or its respective suppliers are not responsible for the suitability of the information contained in this document for any reason. The information is provided "as is", and Yealink does not provide any warranty and is subject to change without notice. All risks other than risks caused by use of the information are borne by the recipient. In no event, even if Yealink has been suggested the occurrence of

damages that are direct, consequential, incidental, special, punitive or whatsoever (Including but not limited to loss of business profit, business interruption or loss of business information), shall not be liable for these damages.

End User License Agreement

This End User License Agreement ("EULA") is a legal agreement between you and Yealink. By installing, copying or otherwise using the Products, you: (1) agree to be bounded by the terms of this EULA, (2) you are the owner or an authorized user of the device, and (3) you represent and warrant that you have the right, authority and capacity to enter into this agreement and to abide by all its terms and conditions, just as if you had signed it. The EULA for this product is available on the Yealink Support page for the product.

Patent Information

China, the United States, EU (European Union) and other countries are protecting one or more patents of accompanying products and/or patents being applied by Yealink.

Customer Feedback

We are striving to improve our documentation quality and we appreciate your feedback. Email your opinions and comments to DocsFeedback@yealink.com.

Technical Support

Visit Yealink WIKI (<http://support.yealink.com/>) for the latest firmware, guides, FAQ, Product documents, and more. For better service, we sincerely recommend you to use Yealink Ticketing system (<https://ticket.yealink.com>) to submit all your technical issues.

GNU GPL INFORMATION

Yealink DECT desk phone firmware contains third-party software under the GNU General Public License (GPL). Yealink uses software under the specific terms of the GPL. Please refer to the GPL for the exact terms and conditions of the license.

The original GPL license, source code of components licensed under GPL and used in Yealink products can be downloaded online: http://www.yealink.com/onepage_83.html.

Table of Contents

About This Guide.....	1
In This Guide.....	1
Getting Started.....	1
Package Contents.....	1
Optional Accessories.....	2
Installing the DD Phone.....	2
Attaching the Stand or the Wall Mount Bracket.....	3
Connecting the Handset and Headset.....	3
Connecting the Power Adapter.....	4
Attaching the DD10K.....	4
Installing the Base Station.....	4
Switching between DD Phone Mode and SIP Mode.....	5
Switching from SIP Mode to DD Phone Mode.....	6
Switching from DD Phone Mode to SIP Mode.....	6
Overview.....	7
Phone Hardware Overview.....	7
Hardware Description.....	7
Power LED Indicator.....	8
Line Key LED.....	9
Base Station Hardware Overview.....	10
Phone Screen and Icons.....	11
Idle Screen Display.....	11
Icon Instructions.....	12
User Interfaces.....	12
Phone User Interface.....	13
Web User Interface.....	13
Basic Operations.....	15
Entering Characters.....	15
Phone Registration.....	16
Registering a DD Phone.....	16
De-registering a DD Phone.....	16
Basic Network Settings.....	17
Configuring the IP Address Mode.....	17

Configuring Static IP Address	17
Configuring Static DNS When DHCP is Enabled	18
Checking System Status	18
Registering Accounts	20
Adjusting Volume	20
Phone Lock	21
Phone Lock Types	21
Activating the Phone Lock	21
Changing the Phone Unlock PIN	22
Unlocking the Phone	22
Locating a DD Phone	22
Customizing Soft Keys	23
Phone Settings	25
Phone Name	25
Language	26
Ring Tones	26
Setting a Ring Tone for the Phone	26
Setting a Ring Tone for a Specific Account	27
Key Tone	27
Backlight	27
Time & Date	28
Setting the Time and Date Manually	28
Configuring the Time and Date Format	28
Configuring the DST	29
Contact Management	31
Local Directory	31
Blacklist	33
Remote Phone Book	34
Call History Management	36
Recent Call In Dialing	37
Dial Plan	37
Replace Rule	38
Dial Now	40
Area Code	41
Block Out	42
Emergency Numbers	42
Outgoing Lines	43
Incoming Lines	44
Key As Send	46
Speed Dial	46
Configuring a Speed Dial Key	46
Placing a Call Using Speed Dial Key	47
Base Reboot	47

Phone Reboot.....	47
Base PIN (Administrator Password)	47
Base Reset.....	48
Phone Reset.....	48
Auto Provision	49
Call Features	51
Placing Calls.....	51
Placing Internal Calls	52
Placing External Calls	52
Answering Calls.....	53
Ending Calls	54
Redialing Calls	54
Call Mute	55
Call Hold/Resume	55
Call Waiting	56
Do Not Disturb (DND)	56
Call Forward.....	57
Call Transfer.....	58
Conference Call.....	59
Local Conference	59
Network Conference.....	60
Call Park.....	61
FAC Mode.....	61
Transfer Mode	62
Anonymous Call.....	63
Anonymous Call Rejection.....	64
Voice Mail	66
Shared Call Appearance (SCA).....	67
Configuring SCA Feature	68
Using SCA Feature on the Phone	70
Multicast Paging	72
Sending RTP Stream	72
Receiving RTP Stream.....	74
Using Multicast Paging.....	75
Troubleshooting.....	77
Base Issue	77
Phone Issue.....	77
Register Issue.....	77
Call Issue.....	78
Paging Issue.....	78
Audio Issue	78

Display Issue	79
Update & Reset Issue	79
Log Issue.....	80
Appendix.....	85
Appendix A - Time Zones	85
Appendix B - Menu Structure	86

About This Guide

You can turn Yealink SIP-T41S/T42S IP phone to the DECT desk phone (hereinafter referred to as DD phone) by using a DECT dongle kit DD10K. The DD phone acts as a handset for the W60B base station.

This guide provides everything you need to use your new DD phone quickly. Firstly, verify with your system administrator that the network is ready for phone configuration. Also, be sure to read the [Getting Started](#) section in this guide and the [Yealink Products Regulatory Notices guide](#) on the phone's support page before you set up and use your DD phone.

In This Guide

Chapters in this guide include:

- Chapter 1 [About This Guide](#)
- Chapter 2 [Getting Started](#)
- Chapter 3 [Overview](#)
- Chapter 4 [Basic Operations](#)
- Chapter 5 [Phone Settings](#)
- Chapter 6 [Call Features](#)
- Chapter 7 [Troubleshooting](#)
- Chapter 8 [Appendix](#)

Getting Started







This chapter mainly describes how to install the DD phone and how to switch between DD phone mode and SIP mode.

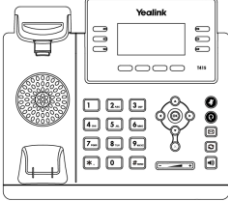

Topics include:

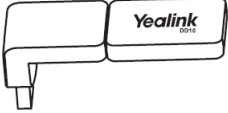
- [Package Contents](#)
- [Installing the DD Phone](#)
- [Installing the Base Station](#)
- [Switching between DD Phone Mode and SIP Mode](#)

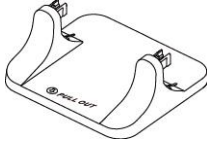
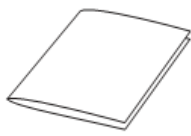
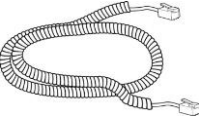
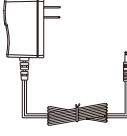
Package Contents

The following components are included in your DD phone package and DD10K package:

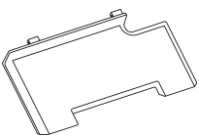
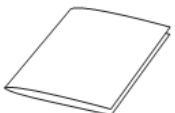
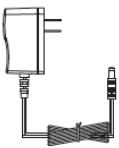
DD Phone Package (Combination Package)		
T41S Package	W60B Package	DD10K Package
1 SIP-T41S IP Phone 	1 W60B Base Station 	1 DD10K 
1 Handset 	1 Base Stand 	1 Quick Start Guide 
1 Handset Cord 	1 Power Adapter 	
1 Ethernet Cable 	1 Ethernet Cable 	

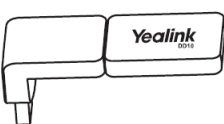
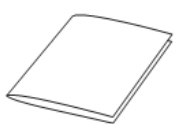
DD Phone Package (Combination Package)		
T41S Package	W60B Package	DD10K Package
<p>1 Stand</p> 	<p>1 Quick Start Guide</p> 	
<p>1 Power Adapter</p> 		
<p>1 Quick Start Guide</p> 		
DD10K Package (Individual Package)		
<p>1 DD10K</p> 	<p>1 Quick Start Guide</p> 	

Optional Accessories

The following items are optional accessories for your DD phone. You need to purchase them separately if required.

Wall Mount Bracket

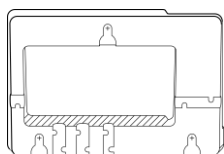

Headset



Wireless Headset Adapter EHS36



Note

We recommend that you use the accessories provided or approved by Yealink. The unapproved third-party accessories may result in poor performance.

Installing the DD Phone

This section introduces how to install the DD phone.

Attaching the Stand or the Wall Mount Bracket

Desk Mount Method

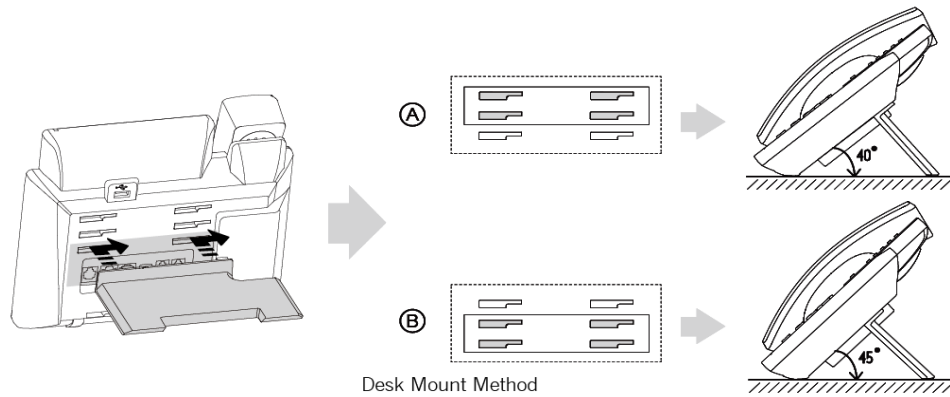

Wall Mount Method (Optional)

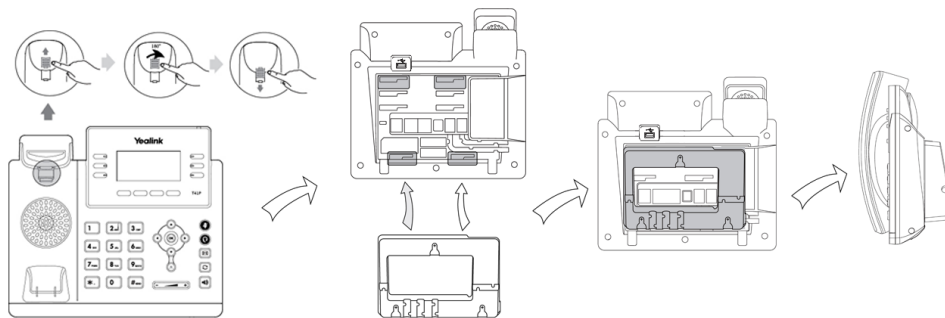

Note The reversible tab has a lip, which allows the handset to stay on-hook when you mount the phone vertically on the wall.

For more information on how to attach the wall mount bracket, refer to [Yealink Wall Mount Quick Installation Guide for Yealink IP Phones](#).

Connecting the Handset and Headset

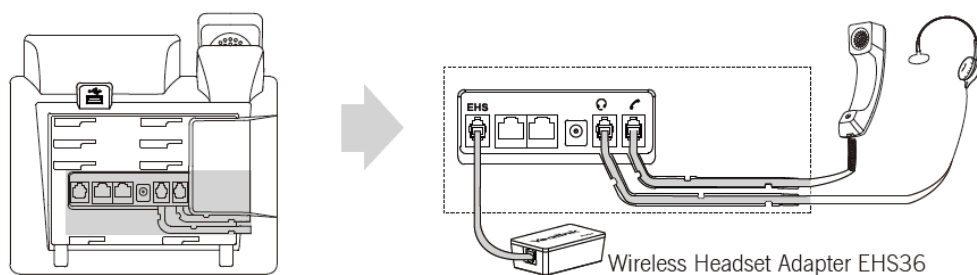

Note You can use EHS36 to connect a compatible wireless headset to the phone. For more information on how to use EHS36, refer to [Yealink EHS36 User Guide](#).

Connecting the Power Adapter

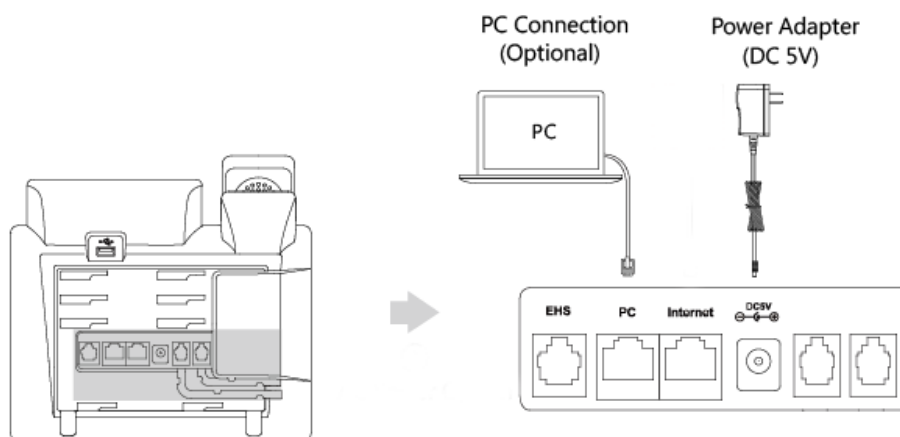

Note We recommend that you use the Yealink original power adapter, since the third-party power adapter may cause the damage to the phone.

Attaching the DD10K

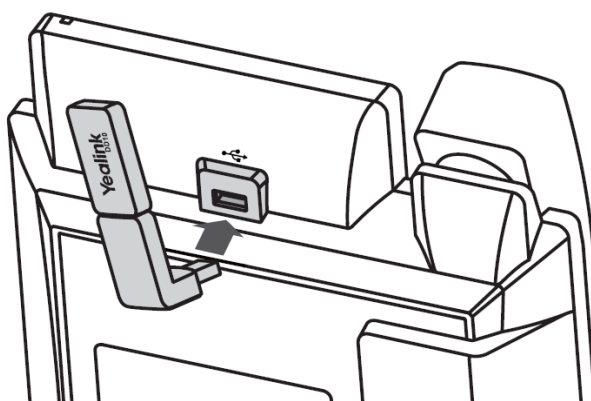

Installing the Base Station

You have two options for power and network connection of the base station. Consult your system administrator for advice.

Note Please pay attention to the radio coverage of the base station. It is up to 300m in unobstructed outdoor areas and up to 50m inside buildings.

Do not place the base station in a damp room, and keep it away from the water.

AC Power Connection

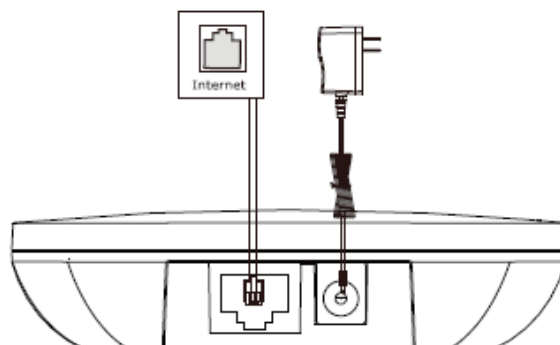

Note We recommend that you use the Yealink original power adapter (5V/600mA), since the third-party power adapter may cause the damage to the base station.

PoE (Power over Ethernet) Connection

With the included or a standard Ethernet cable, you can use a PoE-compliant switch/hub to power the base station.

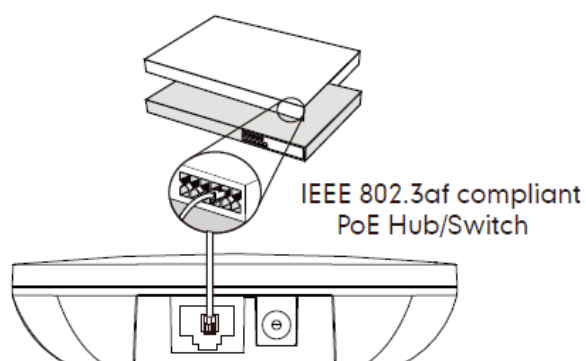

Note If using in-line power, you do not need to connect the power adapter.
Do not remove the power and network to the base station while it is updating firmware and configurations.

Switching between DD Phone Mode and SIP Mode

You can switch between SIP mode and DD phone mode quickly on SIP-T41S/T42S phone:

- SIP mode: the phone acts as a SIP phone, and you can use all features for SIP phone over an IP network.
- DD phone mode: the phone acts as a DECT desk phone, and you can use the phone as a handset for the base station.

Switching from SIP Mode to DD Phone Mode

Before using an IP phone as a DECT desk phone, you should enable the DD phone mode first.

If you attach the DD10K when the phone is powered off, the phone switches to DD phone mode automatically after starting up.

If you attach the DD10K after the phone starts up successfully, you should reboot the phone to switch from SIP mode to DD phone mode.

To reboot the phone to switch from SIP mode to DD phone mode:

1. Long press the X key on the phone.
A message pops up to confirm that you want to reboot the phone.
2. Press the **OK** soft key.
The phone switches to DD phone mode after restart.

Switching from DD Phone Mode to SIP Mode

To switch from DD phone mode to SIP mode:

1. Detach the DD10K.
A message pops up to confirm that you want to reboot the phone and switch to SIP mode.
2. Press the **OK** soft key.
The phone switches to SIP mode after restart.

Overview

This chapter provides the overview of the phone and base station.

Topics include:

- [Phone Hardware Overview](#)
- [Base Station Hardware Overview](#)
- [Phone Screen and Icons](#)
- [User Interfaces](#)





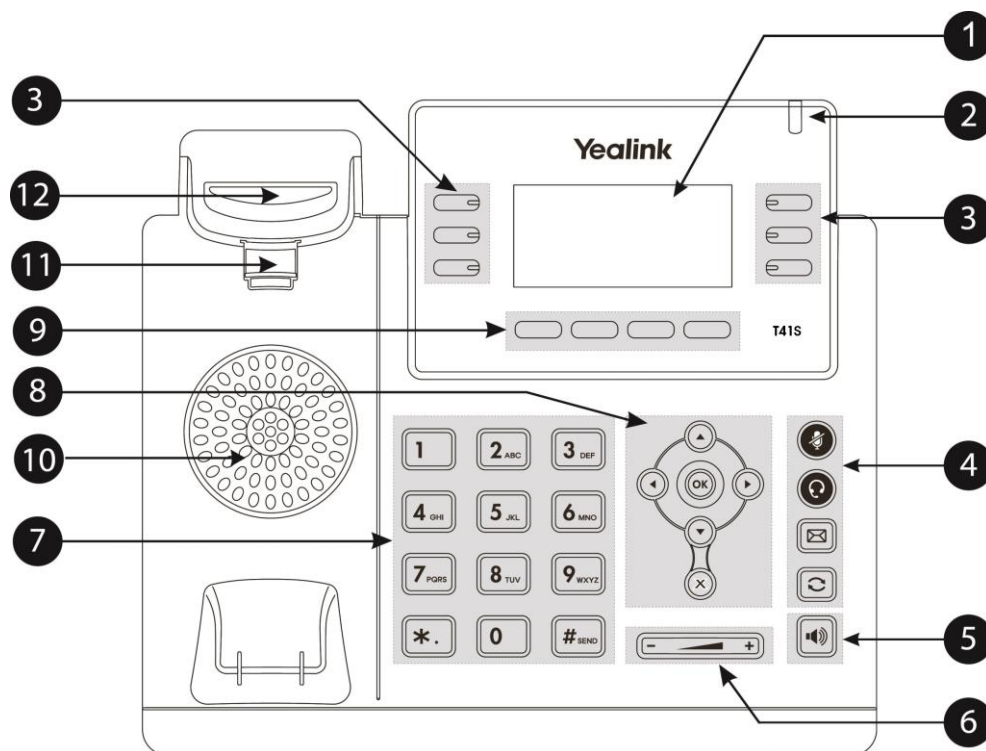

Phone Hardware Overview

Hardware Description

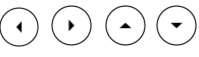

Hardware features description:

No.	Item	Description
1	LCD Screen	Shows a screen with backlight that enables you to view menus and data.
2	Power LED Indicator	Indicates call status, message status and system status.

No.	Item	Description
3	Line Keys	Access your phone outgoing lines and features.
4	 (Mute Key)	Toggles the microphone on or off. The LED indicator glows green when the mute feature is activated.
	 (Headset Key)	Toggles the headset on or off. The LED indicator glows green when the headset is activated.
	 (Message Key)	Accesses your voice mails.
	 (Redial Key)	Redials a previously dialed number.
5	Speakerphone Key	Toggles and indicates the hands-free speakerphone mode.
6	Volume Key	Adjusts the volume of the handset, headset, speaker, or ringer.
7	Keypad Keys	Allow you to enter numbers, letters, and special characters. If a menu item has an index number, you can use the keypad keys to select the item.
8		<ul style="list-style-type: none"> • Scroll through information or options displayed on the screen. • Access History and Directory respectively.
		Confirms actions or answers incoming calls.
		Cancels actions or rejects incoming calls.
9	Soft Keys	Invoke the functions shown adjacent to the soft keys on the screen. The soft keys change depending on what you are doing at the time.
10	Speaker	Provides hands-free (speakerphone) audio output.
11	Reversible Tab	Secures the handset in the handset cradle when you mount the phone vertically. For more information on how to adjust the reversible tab, refer to Yealink Wall Mount Quick Installation Guide for Yealink IP Phones .
12	Hookswitch	Connects or disconnects the phone from the phone line. The hookswitch is automatically activated when a user lifts the handset from the cradle to get a dial tone.

Power LED Indicator

LED Status	Description
Solid red	The phone is initializing.
Fast flashing red (300ms)	The phone is ringing.

LED Status	Description
Slowly flashing red (1s)	The phone receives a voice mail.
Off	The phone is powered off. The phone is idle. The phone is busy. The call is placed on hold or is held. The call is muted.

Line Key LED

Line key LED (default)

LED Status	Description
Solid green	The line is seized. The line is in conversation.
Fast flashing green	The line receives an incoming call.
Slowly flashing green	The call is placed on hold.
Off	The line is inactive.

Line key LED (associated with a shared line)

The local SCA phone is the phone that is involved in an SCA call, while the monitoring SCA phone is not involved in the SCA call.

LED Status	Description
Off	The shared line is idle.
Fast flashing green	The shared line receives an incoming call.
Solid green (for local SCA phone) Solid red (for monitoring SCA phone)	The shared line is in conversation. The shared line is dialing. The shared line is seized. The shared line conversation is barged in by the other shared line party.
Slowly flashing green (for local SCA phone) Slowly flashing red (for monitoring SCA phone)	The shared line conversation is placed on public hold.
Slowly flashing green (for local SCA phone) Solid red (for monitoring SCA phone)	The shared line conversation is placed on private hold.

Base Station Hardware Overview

After the base station starts up successfully and a DD phone is registered to the base station, all LEDs on the base station glow green in sequence.

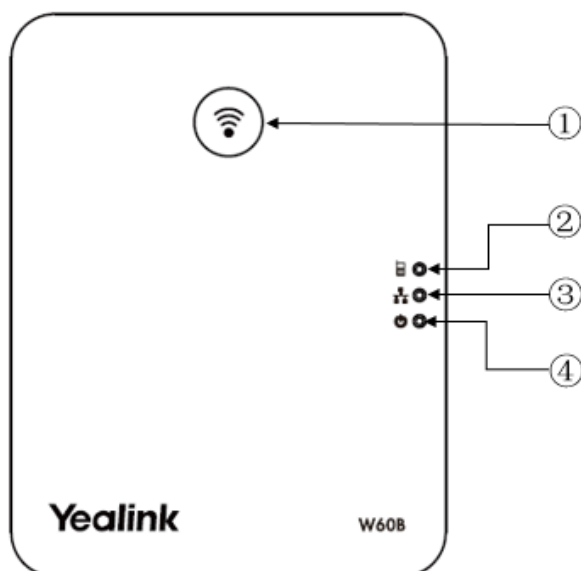

Hardware features description:

No.	Item	Description
1	Paging Key	<ul style="list-style-type: none"> Locates a misplaced DD phone. Toggles the registration mode. Resets the base station to factory settings.
2	Registration LED	Indicates the mode of the base station: <ul style="list-style-type: none"> Fast flashing green—The base station is in the paging mode. Slowly flashing green—The base station is in the registration mode. Solid green—There is at least one DD phone registered to the base station. Off—The base station is powered off or no DD phones are registered to the base station.
3	Network Status LED	Indicates the network status: <ul style="list-style-type: none"> Slowly flashing green—The network is unavailable. Solid green—The network is available. Off—The base station is powered off.
4	Power LED Indicator	Indicates the power status of the base station: <ul style="list-style-type: none"> Slowly flashing green—The base station is upgrading. Solid green—The base station is powered on. Off—The base station is powered off.

Phone Screen and Icons



Before you use the phone, you may need to understand some important information on the state of your phone, such as idle screen layout and icons.

Idle Screen Display

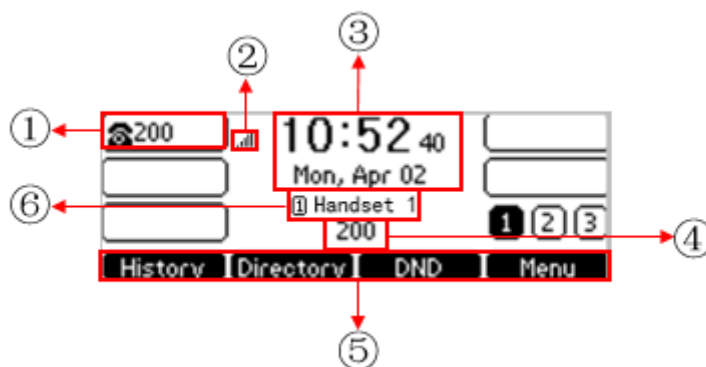
If the DD phone is registered to a base station and is assigned an outgoing line, the idle screen will be displayed as below.





















Idle screen description:

No.	Description
1	This area shows the outgoing line.
2	This area shows signal strength: Weak to strong:  No reception: 
3	This area shows the time and date.
4	This area shows the default outgoing line.
5	This area shows four soft keys.
6	This area shows internal handset number and registered handset (DD phone) name (for example, "1" is internal handset number, indicating the handset (DD phone) is registered on NO.1). Handset 1 to Handset 8: 

Icon Instructions

The following table describes icons appearing on the LCD screen:

Icon	Description
	Internal handset number, from handset 1 to handset 8
	Signal strength indicator, from one bar (weak) to five bars (strong)
	No Reception
	Headset Mode
	Hands-free Speakerphone Mode
	Handset mode
	Phone Lock
DND	Do Not Disturb (DND)
	Voice Mail
	Ringer volume is 0
	Call Forward
	Received Calls
	Missed Calls
	Placed Calls
	Forwarded Calls
	Call Hold
	Call Mute
	The private line registers successfully
	The shared line registers successfully
	Contact Icon

User Interfaces

Two ways to customize configurations of your DD phone:

- The user interface on the DD phone.
- The user interface in a web browser on your computer.

The keypad and LCD screen constitute the phone user interface, which allows the user to execute all call operation tasks and some basic configuration changes directly on the DD phone. In addition, you can use the web user interface to access some configuration settings.

Phone User Interface

You can customize your DD phone by pressing the **Menu** soft key to access the phone user interface. Some options are only accessible to the administrator, and the default administrator password is "0000". To change the administrator password, refer to [Base PIN \(Administrator Password\)](#).

Note For a better understanding of the menu structure, please refer to [Appendix B - Menu Structure](#).

Web User Interface

In addition to the phone user interface, you can also customize some features via web user interface of the base station. In order to access the web user interface, you need to know the IP address of your base station. To obtain the IP address, press **Menu->Status->Base Status** on the DD phone when the phone is idle. Enter the IP address (e.g., <http://192.168.0.10> or 192.168.0.10 for IPv4; [http://\[2005:1:1:1:215:65ff:fe64:6e0a\]](http://[2005:1:1:1:215:65ff:fe64:6e0a]) or [\[2005:1:1:1:215:65ff:fe64:6e0a\]](http://[2005:1:1:1:215:65ff:fe64:6e0a]) for IPv6) in the address bar of a web browser on your PC. The default administrator user name and password are both "admin" (case-sensitive).

Note The access to the Advanced settings of the Account or Network via web user interface may be blocked by the web browser (for example, Chrome, Firefox) if you have installed "Adblock Plus plugin".

If you connect the phone to a network, you can also access the web user interface of the phone. Press **Menu->Status->Phone Status** to obtain the phone IP address. When the phone is in DD phone mode, you can only upgrade the phone (**Settings->Upgrade**) or troubleshoot a phone problem (**Settings->Configuration**) via web user interface.

Basic Operations

This chapter provides you with the basic operation instructions of the DD phone.



Topics include:

- [Entering Characters](#)
- [Phone Registration](#)
- [Basic Network Settings](#)
- [Checking System Status](#)
- [Registering Accounts](#)
- [Adjusting Volume](#)
- [Phone Lock](#)
- [Locating a DD Phone](#)
- [Customizing Soft Keys](#)

Entering Characters

You can use the keypad keys on your phone to enter or update field information.

The following table describes how to enter different characters using the keypad keys:

Task	Action
Switch input modes	Press the ABC , abc , Abc , 2aB , or 123 soft key to switch the input modes.
Enter alphas	Select ABC , abc , 2aB or Abc mode, press the keys labeled with letters until your desired letter appears.
Enter numbers	Select 123 mode, and then press the corresponding keys.
Enter special characters	Select ABC , abc , 2aB , or Abc mode, press * key or # key one or more times to enter one of the following special characters: * key: *,?!\()-()@/,:;+&%= <> £ \$¥¤[]{}~^_`{ }~#\$#" # key: # In 123 mode, you can press * key to choose the following special characters: .*/@[].
Insert space	Select ABC , acb , 2aB , or Abc mode, press the 0 key.
Move cursor	Press  or  to position the cursor.
Delete one or more characters	Position the cursor to the right of the character, and then press the Delete soft key.

Phone Registration

If you purchase the W41P package, the T41S DD phone is registered to the W60B by default, so you can skip the registration process. If you purchase the DD10K package, you should manually register the DD phone to one base station.

You can register up to eight DD phones to one base station. Each DD phone can be registered to only one base station.

Registering a DD Phone

To register a new DD phone manually:

When the phone screen prompts "Unregistered!", long press  on the base station till the registration LED flashes. There are two methods to register a new DD phone:

Easy Registration:

1. Press the **Reg** soft key on the phone to register quickly.

Normal Registration:

1. Do one of the following:
 - Press the **OK** soft key on the phone, and then select **Register Handset**.
 - Press , and then select **Settings->Registration->Register Handset**.

The phone begins searching the base station.

2. Press the **OK** soft key after a base station is found.
3. Enter the base PIN (default: 0000), and then press the **OK** soft key to complete registration.

After the success of registration, the phone screen prompts "Subscribe Succeed".

After initializing data successfully, an icon with internal handset number and registered handset (DD phone) name appear on the LCD screen.

Note

If the phone screen prompts "Searching for Base", please check if your base station is powered on.

De-registering a DD Phone

To de-register a DD phone via phone user interface:

1. Press **Menu->Settings->Registration->DeRegister Handset**.
2. Enter the base PIN (default: 0000), and then press the **OK** soft key.

The phone screen displays the names of DD phones that registered to the same base station. The name of your DD phone itself is highlighted.
3. Select the desired phone name.

The phone screen prompts "De-register Handset".

4. Press the **OK** soft key to de-register the DD phone.

Basic Network Settings

The base station attempts to contact a DHCP server in your network to obtain valid network settings (for example, IP address, subnet mask, gateway address, and DNS address) by default. The DD phone supports either or both IPv4 and IPv6 addresses modes, but IPv6 is disabled by default.

Configuring the IP Address Mode

To configure the IP address mode via phone user interface:

1. Press **Menu->Settings->Advanced Settings** (default password: 0000) ->**Network->WAN Port**.
2. Select **IPv4**, **IPv6**, or **IPv4 & IPv6** from the **IP Mode** field.
3. Press the **Save** soft key.

Configuring Static IP Address

If the base station cannot contact a DHCP server, you need to configure basic network settings manually.

You can configure a static IPv4 address for the base station. Before configuring, make sure that the IP mode is configured as **IPv4** or **IPv4 & IPv6**.

To configure a static IPv4 address via phone user interface:

1. Press **Menu->Settings->Advanced Settings** (default password: 0000) ->**Network->WAN Port**.
2. Select **IPv4**.
3. Select **Static IPv4 Client**.
4. Enter the desired value in the **IP Address**, **Subnet Mask**, **Default Gateway**, **Pri.DNS**, and **Sec.DNS** field respectively.
5. Press the **Save** soft key.

The base station reboots automatically to make settings effective after a period of time.

You can also configure a static IPv6 address for the base station. Before configuring, make sure that the IP mode is configured as **IPv6** or **IPv4 & IPv6**.

To configure a static IPv6 address via phone user interface:

1. Press **Menu->Settings->Advanced Settings** (default password: 0000) ->**Network->WAN Port**.
2. Select **IPv6**.
3. Select **Static IPv6 Client**.
4. Enter the desired value in the **IP Address**, **IPv6 IP Prefix**, **Default Gateway**, **Pri.DNS**, and **Sec.DNS** field respectively.

5. Press the **Save** soft key.

Note Wrong network settings may result in inaccessibility of your phone and may also have an impact on your network performance. For more information on these parameters, contact your system administrator.

Configuring Static DNS When DHCP is Enabled

Usually, static DNS is not required when DHCP is enabled on your phone. But in some cases, static DNS may be needed in your environment. Then you can manually configure static DNS to ignore DNS obtained from DHCP.

You can configure a static IPv4 DNS for the base station. Before configuring, make sure that the IP address mode is configured as **IPv4** or **IPv4 & IPv6**.

To configure static IPv4 DNS manually via phone user interface:

1. Press **Menu->Settings->Advanced Settings** (default password: 0000) ->**Network->WAN Port**.
2. Select **IPv4**.
3. Select **DHCP IPv4 Client**.
4. Select **Enabled** from the **Static DNS** field.
5. Enter the desired value in the **Pri.DNS** and **Sec.DNS** field respectively.
6. Press the **Save** soft key.

The base station reboots automatically to make settings effective after a period of time.

You can also configure a static IPv6 DNS for the base station. Before configuring it, make sure that the IP mode is configured as **IPv6** or **IPv4 & IPv6**.

To configure static IPv6 DNS manually via phone user interface:

1. Press **Menu->Settings->Advanced Settings** (default password: 0000) ->**Network->WAN Port**.
2. Select **IPv6**.
3. Select **DHCP IPv6 Client**.
4. Select **Enabled** from the **Static DNS** field.
5. Enter the desired value in the **Pri.DNS** and **Sec.DNS** field respectively.
6. Press the **Save** soft key.

The base station reboots automatically to make settings effective after a period of time.

Checking System Status

You can view the system status on your DD phone. Available information of the system status includes:

- **Base station status** (IPv4 status or IPv6 status, MAC address, firmware version, RFPI, device certificate status, and network information)

- IPv4 uses a 32-bit address.
- IPv6 is an updated version of the current Internet Protocol to meet the increased demands for unique IP addresses, using a 128-bit address.
- **Phone status** (IPv4 status or IPv6 status, MAC address, OTA version, network information, and phone information)
- **Dongle status** (model, hardware version, app version, match result, rom version, IPU code, SN code, and area)
- **Line status**



Note

You can only check the Phone status and Dongle status if the phone does not register to a base station.

To check the base station status via phone user interface:

1. Press **Menu->Status->Base Status**.



The LCD screen displays status information of the base station and the **Network** option.

2. Press  or  to scroll through the list and view the status information.
3. Highlight **More**, and then press the **Enter** soft key.

The LCD screen displays the connected network information.

To check the phone/dongle status via phone user interface:

1. Press **Menu->Status->Phone Status/Dongle Status**.

2. Press  or  to scroll through the list and view the specific information.

To check the line status via phone user interface:

1. Press **Menu->Status->Line Status**.

The LCD screen displays all lines registered to the currently used base station with a key word for indicating the line status.

Key Word	Description
Outgoing line	Indicates the line is only an outgoing line. You can place outgoing calls but cannot receive incoming calls on this line.
Incoming line	Indicates the line is only an incoming line. You can receive incoming calls but cannot place outgoing calls on this line.
Unauthorized	Indicates the line is neither an outgoing line nor an incoming line. You cannot place a call using this line and receive incoming calls on this line.
Authorized	Indicates the line is an outgoing line and an incoming line. You can place a call using this line and receive incoming calls on this line.

Registering Accounts

The base station supports up to eight lines. You can register an account for each line via web user interface.

To register an account via web user interface:

1. Click **Account->Register**.
2. Select the desired account from the pull-down list of **Account**.
3. Select **Enabled** from the pull-down list of **Line Active**.
4. Enter the valid value in the **Label**, **Display Name**, **Register Name**, **User Name**, **Password**, and **SIP Server1/2** field respectively.

The screenshot shows the Yealink W608 web interface. The 'Account' tab is selected, and the 'Register' page is displayed. The 'Account' dropdown is set to 'Account1'. The 'Line Active' dropdown is set to 'Enabled'. The 'SIP Server 1' section includes the following fields: Server Host (10.200.108.48), Port (5060), Transport (UDP), Server Expires (3600), and Server Retry Counts (3). A 'NOTE' box on the right contains the following text:

NOTE

Account Registration
Registers account(s) for the IP phone.

Server Redundancy
It is often required in VoIP deployments to ensure continuity of phone service, for events where the server needs to be taken offline for maintenance, the server fails, or the connection between the IP phone and the server fails.

NAT Traversal
A general term for techniques that establish and maintain IP connections traversing NAT gateways. STUN is one of the NAT traversal techniques.

You can configure NAT traversal for this account.

5. If you use the outbound proxy servers, do the following:
 - 1) Select **Enabled** from the pull-down list of **Enable Outbound Proxy Server**.
 - 2) Enter the desired value in the **Outbound Proxy Server 1/2** and **Proxy Fallback Interval** field respectively.

Contact your system administrator for the account information.
6. Click **Confirm**.

Adjusting Volume

When you are during a call, you can increase or decrease the volume of currently engaged audio devices (handset, speakerphone, or headset).

When the phone is idle or ringing, you can increase or decrease the ringer volume. If ringer volume is adjusted to the minimum, the minimum volume icon  will appear on LCD screen.

To adjust the volume:

1. Press  .



Phone Lock

You can lock your phone temporarily when you are not using it. This feature helps to prevent unauthorized outgoing calls, or prevent people from viewing or modifying your private information, such as call lists or directory.

Phone Lock Types

Phone lock type consists of the following:

Menu key: The **Menu** soft key is locked. You cannot access the menu of the phone until unlocked.

Function key: The function keys are locked. You cannot use , , , OK, X, navigation keys and soft keys until unlocked.

All keys: All keys are locked, except the Volume key, digit keys, # key, * key and Speakerphone key. You can only do the following:

- Dial emergency numbers.
- Reject incoming calls by pressing the X key or the **Reject** soft key.
- Answer incoming calls by lifting the handset, or pressing the Speakerphone key/HEADSET key/**Answer** soft key/OK key.
- End the call by hanging up the handset, or pressing the Speakerphone key/**End Call** soft key/X key.

Note

To place emergency calls, you should configure the emergency numbers in advance. For more information, refer to [Emergency Numbers](#).

Activating the Phone Lock

By default, the phone lock feature is disabled. If you want to lock your phone, you need to enable this feature. You can select which type to lock your phone and specify the waiting time that how soon the phone is locked automatically.

To activate the phone lock via phone user interface:

1. Press **Menu**->**Settings**->**Basic Settings**->**Phone Lock**.
2. Enter the desired PIN (default: 123) in the **Unlock PIN** field, and then press the **OK** soft key.
3. Select **Enabled** from the **Lock Enable** field.
4. Select the desired type from the **Lock Type** field.
5. Enter the desired interval of automatic phone lock in the **Lock Time Out** field.

The default timeout is 0. It means the phone will not be automatically locked. You need to long press



to lock it immediately when the phone is idle.

If it is set to other values except 0 (for example, 5), the phone will be locked when the phone is inactive in idle screen for the designated time (in seconds).

6. Press the **Save** soft key.

When the phone is locked, the LCD screen prompts "Phone locked." and displays the icon .

Changing the Phone Unlock PIN

The default phone unlock PIN is 123. You can change the PIN as required.

To change the PIN via phone user interface:

1. Press **Menu->Settings->Basic Settings->Change PIN**.
2. Enter the desired value in the **Old PIN**, **New PIN**, and **Confirm PIN** field respectively.
3. Press the **Save** soft key.

Note The unlock PIN length must be within 15 digits.

Unlocking the Phone

You can use the phone unlock PIN to unlock the phone.

To unlock the phone via phone user interface:

1. Press any locked key to enter the "Phone Lock" screen.
2. Enter the desired PIN (default: 123) in the **Unlock PIN** field.
3. Press the **OK** soft key.

The icon  disappears from the LCD screen.

Locating a DD Phone

You can locate a misplaced registered DD phone using the base station.

To locate a DD phone via base station:

1. Press  on the base station.

All DD phones that are registered to this base station will ring (paging) simultaneously and display the IP address of the base station on the phone screen.

This helps you locate your DD phone easily.

You can press any key on one of the phones or press  again on the base station to end ringing (paging).

You can also locate DD phones via web user interface at the path **Status->Handset&VoIP->Paging Status**.

Customizing Soft Keys

The default soft keys on the idle screen are "History", "Directory", "DND", and "Menu". You can customize the functions of the soft keys. You can use soft keys to invoke frequently used functions, or to create menu shortcuts to access frequently used phone settings.

Note

We recommend that you should keep a **Menu** soft key; otherwise, you may not access the phone settings.

To customize soft keys via phone user interface:

1. Press **Menu**->**Settings**->**Advanced Settings** (default password: 0000) ->**Softkey Label**.
2. Select the desired soft key.
3. Select the desired key type from the **Type** field.
4. (Optional) Select the desired line from the **Account ID** field.
5. (Optional) Enter the string that will appear on the LCD screen in the **Label** field.
6. (Optional) Enter the corresponding value in the **Value** field.
7. Press the **Save** soft key.

Phone Settings

This chapter provides you with some instructions on how to change the settings of your phone.

Topics include:

- [Phone Name](#)
- [Language](#)
- [Ring Tones](#)
- [Key Tone](#)
- [Backlight](#)
- [Time & Date](#)
- [Contact Management](#)
- [Call History Management](#)
- [Recent Call In Dialing](#)
- [Dial Plan](#)
- [Emergency Numbers](#)
- [Outgoing Lines](#)
- [Incoming Lines](#)
- [Key As Send](#)
- [Speed Dial](#)
- [Base Reboot](#)
- [Phone Reboot](#)
- [Base PIN \(Administrator Password\)](#)
- [Base Reset](#)
- [Phone Reset](#)
- [Auto Provision](#)

Phone Name

The DD phone will be assigned a name by default if successfully registered to the base station. You can personalize the phone name.

To rename the phone via phone user interface:

1. Press **Menu**->**Settings**->**Basic Settings**->**Phone Name**.
2. Edit the current name in the **Phone Name** field.

3. Press the **Save** soft key.

Phone name is also configurable via web user interface at the path **Account->Handset Name**.

Language

Both DD phone and web user interface support the following nine languages: English, French, German, Italian, Polish, Portuguese, Spanish, Turkish, and Russian. You can change the language for the phone and the web user interface respectively.

To change the language for the phone user interface:

1. Press **Menu->Settings->Basic Settings->Language**.
2. Select the desired language.
3. Press the **Save** soft key.

Text will be displayed in the selected language.

To change the language for the web user interface:

1. Select the desired language from the pull-down list at the top-right corner of web user interface.

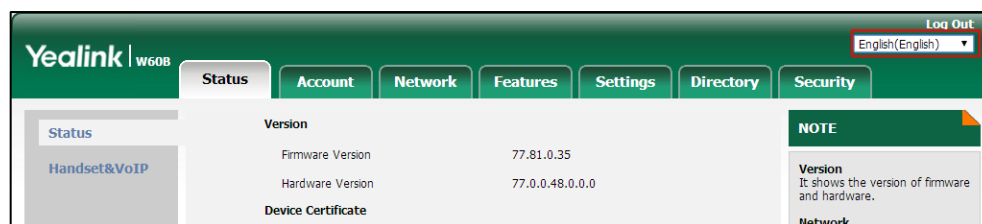

Text will be displayed in the selected language in the web user interface.

Ring Tones

Ring tones are the sound used to indicate incoming calls. You can distinguish your phone from your neighbor's phone. When receiving an incoming call, the DD phone rings the specified ring tone.

Setting a Ring Tone for the Phone

You can select a ring tone for all incoming calls.

To select a ring tone for the phone via phone user interface:

1. Press **Menu->Settings->Basic Settings->Sound->Ring Tones->Common**.
2. Select the desired ring tone.
3. (Optional) Press  to adjust the ringer volume.
4. Press the **Save** soft key.

Setting a Ring Tone for a Specific Account

You can select a unique ring tone for incoming calls of a specific account.

Note A ring tone for a specific account takes effect on the incoming lines that assigned to the DD phone. For more information on assigning incoming lines, refer to [Incoming Lines](#).

To select a ring tone for the account via phone user interface:

1. Press **Menu->Settings->Basic Settings->Sound->Ring Tones**.
2. Select the desired account.
The LCD screen displays all accounts registered to the currently used base station.
3. Select the desired ring tone.
If **Common** is selected, the incoming calls of this account will use the ring tone set for the phone.
4. (Optional) Press  to adjust the ringer volume.
5. Press the **Save** soft key.

Key Tone

If you enable key tone, the phone will produce a sound when you press the keypad.

To configure key tone via phone user interface:

1. Press **Menu->Settings->Basic Settings->Sound->Key Tone**.
2. Select the desired value from the **Key Tone** field.
3. Press the **Save** soft key.

Backlight

You can configure the backlight to adjust the brightness of the phone screen. Backlight status on the phone screen can be configured from the following options:

- **Always On:** Backlight is on permanently.
- **Always Off:** Backlight is off permanently.
- **15s, 30s, 1min, 2min, 5min, 10min, or 30min:** Backlight is turned off when the phone is inactive after the designated time (in seconds).

To configure the backlight via phone user interface:

1. Press **Menu->Settings->Basic Settings->Display->Backlight**.
2. Select the desired time from the **Backlight Time** field.
3. Press the **Save** soft key.

Time & Date

The time and date display on the idle screen of your DD phone. By default, the phone obtains the date and time from the Simple Network Time Protocol (SNTP) server.

Setting the Time and Date Manually

If your phone cannot obtain the time and date from the SNTP server, you need to configure the time and date manually.

To configure time and date manually for all DD phones via web user interface.

1. Click **Settings**->**Time & Date**.
2. Select **Enabled** from the pull-down list of **Manual Time**.
3. Enter the time and date in the corresponding fields.

The screenshot shows the 'Time&Date' configuration page in the Yealink W608 web interface. The 'Manual Time' dropdown is set to 'Enabled' and is highlighted with a red box. Below it, the date is configured as Year 2018, Month 3, Day 28, and the time is configured as Hour 16, Minute 40, Second 16. The 'Time Format' is set to 'Hour 24' and the 'Date Format' is set to 'WWW MMM DD'. A 'NOTE' section on the right provides additional information about Time and Date, Time Zone, and NTP Server.

4. Click **Confirm**.

To configure time and date manually for a specific DD phone via phone user interface:

1. Press **Menu**->**Settings**->**Basic Settings**->**Time & Date**->**Manual Setting**.
2. Edit the desired value in the **Date** and **Time** field respectively.
3. Press the **Save** soft key.

The time and date displayed on the LCD screen will change accordingly.

Note Before you configure time and date manually for a specific DD phone, you should enable the **Manual Time** via web user interface first, or it would not take effect.

Configuring the Time and Date Format

You can configure the time format and date format respectively. The DD phone supports two time formats (**12 Hour** or **24 Hour**) and seven date formats.

The following table lists the available date formats:

Date Format	Example (2018-04-04)
WWW MMM DD	Wed, Apr 04
DD-MMM-YY	04-Apr-18
YYYY-MM-DD	2018-04-04
DD/MM/YYYY	04/04/2018
MM/DD/YY	04/04/18
DD MMM YYYY	04 Apr, 2018
WWW DD MMM	Wed, 04 Apr

To configure the time and date format for a specific DD phone via phone user interface:

1. Press **Menu->Settings->Basic Settings->Time & Date->Time & Date Format**.
2. Select the desired time format (**12 Hour** or **24 Hour**) from the **Time Format** field.
3. Select the desired date format from the **Date Format** field.
4. Press the **Save** soft key.

The time and date format on the LCD screen updates immediately.

Time and date format for all DD phones are configurable via web user interface at the path **Settings->Time & Date**.

Configuring the DST

To configure the DST automatically via web user interface:

1. Click **Settings->Time & Date**.
2. Mark the **Automatic** radio box in the **Daylight Saving Time** field.
3. Select the desired time zone from the pull-down list of **Time Zone**.
4. Select the desired time zone name from the pull-down list of **Location**.

The pull-down list of **Location** displays the corresponding time zone names for the time zone you selected.

If the selected location uses daylight saving time, the **Start Date**, **End Date** and **Offset(minutes)** fields will be filled with time automatically. All of them are read-only.

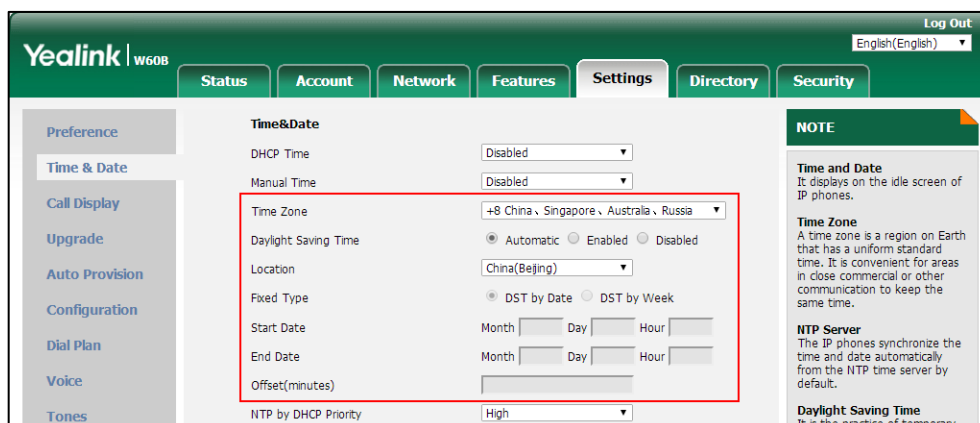

5. Click **Confirm**.

The phone will use the daylight saving time of the selected location.

Note If the location you select does not use daylight saving time, the fields of **Start Date**, **End Date** and **Offset(minutes)** will be left blank.

To configure the DST manually via web user interface:

1. Click **Settings**->**Time & Date**.
2. Select the desired time zone from the pull-down list of **Time Zone**.
3. Mark the **Enabled** radio box in the **Daylight Saving Time** field.
4. Do one of the following:
 - Mark the radio box of **DST by Date** in the **Fixed Type** field.
 Enter the start date and end date in the corresponding fields.

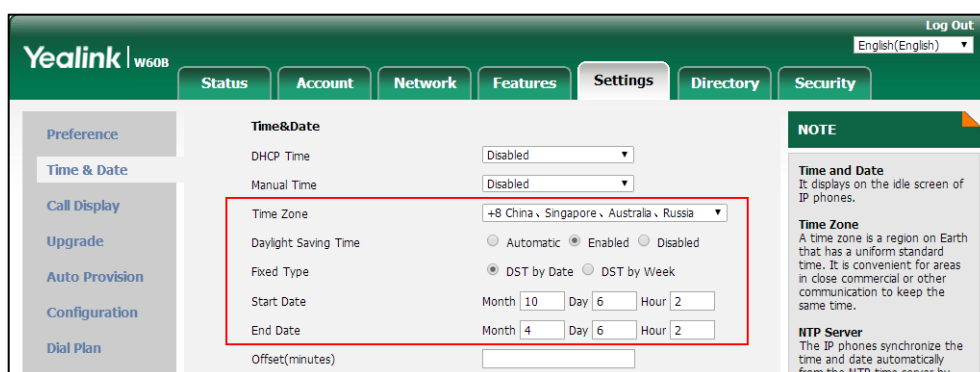

- Mark the radio box of **DST by Week** in the **Fixed Type** field.
Select the desired date from the pull-down lists of **Start Date** and **End Date**.

The screenshot shows the Yealink W608 web interface. The 'Settings' tab is active, and the 'Time & Date' section is expanded. The 'Fixed Type' field is set to 'DST by Week'. The 'Start Date' and 'End Date' fields are highlighted with a red box. The 'Start Date' is set to January, First In Mo, Sunday, 02:00. The 'End Date' is set to April, First In Mo, Sunday, 04:00. The 'Offset(minutes)' field is empty.

5. Enter the offset time (in minutes) in the **Offset(minutes)** field.
6. Click **Confirm**.

Note Please refer to [Appendix A - Time Zones](#) for the list of available time zones on the phone.

To disable the DST via web user interface:

1. Click **Settings**->**Time & Date**.
2. Mark the **Disabled** radio box in the **Daylight Saving Time** field.
3. Click **Confirm**.

Contact Management

This section provides operating instructions on how to manage contacts.

Topics include:

- [Local Directory](#)
- [Blacklist](#)
- [Remote Phone Book](#)

Local Directory

You can store the frequently used contacts in the phone's local directory, where names and numbers can be freely added, deleted, and edited. You can store up to 1000 contacts per DD phone, each with a name, a mobile number, and an office number. You can also dial a contact from the local directory, that allows you to place calls without having to dial the number manually.

Adding Contacts

You can add contacts to your local directory manually or from the call history.

You can also add contacts to your local directory from the remote phone book. For more information,

refer to [Remote Phone Book](#).

To add a contact to the local directory manually via phone user interface:

1. Press the **Directory** soft key or **Menu->Directory->Local Directory**.
2. Press the **Add** soft key.
3. Enter the name and the office, mobile or other numbers in the corresponding fields.
4. Press the **Add** soft key.

To add a contact to the local directory from the call history via phone user interface:

1. Press the **History** soft key or **Menu->History**.
2. Highlight the desired entry.
3. Press the **Option** soft key, and then select **Add to Contact**.
4. Enter the contact name.
5. Press the **Save** soft key.

Note

When you add a contact, the name is required.

If the contact already exists in the local directory, the LCD screen will prompt "Contact name existed!".

Editing Contacts

You can change or add more information to your contacts at any time.

To edit a contact in the local directory via phone user interface:

1. Press the **Directory** soft key or **Menu->Directory->Local Directory**.
2. Highlight the desired contact.
3. Press the **Options** soft key, and then select **Detail**.
4. Edit the contact information.
5. Press the **Save** soft key.

Deleting Contacts

You can delete a contact or all contacts from the local directory.

To delete a contact via phone user interface:

1. Press the **Directory** soft key or **Menu->Directory->Local Directory**.
2. Highlight the desired contact.
3. Press the **Options** soft key, and then select **Delete**.
A message pops up to confirm that you want to delete the contact.
4. Press the **OK** soft key.

To delete all contacts via phone user interface:

1. Press the **Directory** soft key or **Menu->Directory->Local Directory**.
2. Press the **Options** soft key, and then select **Delete All**.
A message pops up to confirm that you want to delete all contacts.
3. Press the **OK** soft key.

Searching for Contacts

You can search for the contacts by simply entering a few continuous characters of the desired contact name or number, and the results of potential matches are dynamically filtered and displayed on the LCD screen.

To search for contacts in the local directory via phone user interface:

1. Press the **Directory** soft key or **Menu->Directory->Local Directory**.
2. Enter a few continuous characters of the desired contact name or number.
The contact whose name or number matches the search will appear on the LCD screen after a timeout. You can dial a contact from the result list.

Placing a Call from Local Directory

To place a call from the local directory via phone user interface:

1. Press the **Directory** soft key or **Menu->Directory->Local Directory**.
2. Highlight the desired contact.
3. Do one of the following:
 - If only one number for the contact is stored in the local directory, press the **Send** soft key to dial out the number.
 - If multiple numbers for the contact are stored in the local directory, press the **Send** soft key to display a list of numbers.
Highlight the desired number.
Press the **Send** soft key to dial out the number.

Blacklist

You can store up to 30 contacts in one DD phone's blacklist. You can add, edit, or delete contacts in the blacklist. An incoming call from a contact in the blacklist will be rejected automatically.

Adding a Blacklist Contact

To add an entry to the blacklist manually via phone user interface:

1. Press **Menu->Directory->Blacklist**.
2. Press the **Add** soft key.

3. Enter the office number in the **Office Number** field.
4. Press the **Add** soft key.

Editing a Blacklist Contact

You can change information for your blacklist contacts at any time.

To edit a blacklist entry via phone user interface:

1. Press **Menu->Directory->Blacklist**.
2. Highlight a desired blacklist contact, and then press the **Option** soft key.
3. Select **Detail**.
4. Edit the office number.
5. Press the **Save** soft key.

Deleting Blacklist Contacts

You can delete a blacklist contact or all blacklist contacts to make room for new blacklist contact.

To delete an entry from the blacklist via phone user interface:

1. Press **Menu->Directory->Blacklist**.
2. Highlight the desired contact.
3. Press the **Options** soft key, and then select **Delete**.
A message pops up to confirm that you want to delete the contact.
4. Press the **OK** soft key.

To delete all entries from the blacklist via phone user interface:

1. Press **Menu->Directory->Blacklist**.
2. Press the **Options** soft key, and then select **Delete All**.
A message pops up to confirm that you want to delete all contacts.
3. Press the **OK** soft key.

Remote Phone Book

You can access your remote phone book on your DD phone. You can add contacts to the local directory from the remote phone book. You can also dial a contact from the remote phone book. Contact your system administrator for the access URL of the remote phone book.

To configure the access URL of the remote phone book via web user interface:

1. Click **Directory->Remote Phone Book**.
2. Enter the access URL in the **Remote URL** field.

3. Enter the name in the **Display Name** field.

Index	Remote URL	Display Name
1	http://10.2.5.204:8080/Department.xml	Department
2		
3		
4		
5		

Incoming/Outgoing Call Lookup: Enabled

Update Time Interval(Seconds): 21600

NOTE
Remote Phone Book
 It is a centrally maintained phone book, stored on the remote server.
 Users only need the access URL of the remote phone book. The IP phone can establish a connection with the remote server and download the phone book, and then display the remote phone book entries on the phone user interface.
 You can click here to get more guides.

4. Click **Confirm**.

Note All DD phones that are registered to the base station can access to the remote phone book.

You can enable the DD phone to present the caller/callee identity stored in the remote phone book when receiving/placing a call.

To configure incoming/outgoing call lookup and update time interval via web user interface:

1. Click **Directory->Remote Phone Book**.
2. Select **Enabled** from the pull-down list of **Incoming/Outgoing Call Lookup**.
3. Enter the desired refresh period in the **Update Time Interval(Seconds)** field.

Index	Remote URL	Display Name
1	http://10.2.5.204:8080/Department.xml	Department
2		
3		
4		
5		

Incoming/Outgoing Call Lookup: Enabled

Update Time Interval(Seconds): 21600

NOTE
Remote Phone Book
 It is a centrally maintained phone book, stored on the remote server.
 Users only need the access URL of the remote phone book. The IP phone can establish a connection with the remote server and download the phone book, and then display the remote phone book entries on the phone user interface.
 You can click here to get more guides.

4. Click **Confirm**.

To access your remote phone book via phone user interface:

1. Press **Menu->Directory->Remote Phone Book**.
2. Select the desired remote phone book.

The phone connects to the remote phone book and proceeds to load it. The contacts in the remote phone book are displayed on the LCD screen.

To place a call from the remote phone book:

1. Press **Menu->Directory->Remote Phone Book**.
2. Select the desired remote phone book.
3. Select the desired contact from the remote phone book.
4. Do one of the following:
 - If only one number for the contact is stored in the local directory, press the **Send** soft key to dial out the number.
 - If multiple numbers for the contact are stored in the local directory, press the **Send** soft key to view a list of numbers.
Highlight the desired number.
Press the **Send** soft key to dial out the number.

To add a contact to the local directory from the remote phone book via phone user interface:

1. Press **Menu->Directory->Remote Phone Book**.
2. Select the desired remote phone book.
3. Select the desired contact from the remote phone book.
4. Press the **Options** soft key, and then select **Add to Contact**.
5. Enter the contact name.
6. Press the **Save** soft key.

Call History Management

Call history contains call information such as calling/called party identification, time and date, and call duration.

You can check the detailed information of an entry in the call history. If the name and number of calling/called party is in the directory, the list displays the calling/called party name (matching priority: Local Directory>Remote Phone Book), or it will display the number instead. You can also dial a call, add an entry to the local directory, or delete all entries from the call history.

To view call history via phone user interface:

1. Press the **History** soft key.
The LCD screen displays all call records.
2. Highlight the desired entry.
3. Press the **Options** soft key, and then select **Detail**.
The detailed information of the entry appears on the LCD screen.

To delete an entry from the call history via phone user interface:

1. Press the **History** soft key.
2. Highlight the desired entry.

3. Press the **Delete** soft key.
The selected entry is deleted successfully.

To delete all entries from the call history via phone user interface:

1. Press the **History** soft key.
2. Press the **Options** soft key, and then select **Delete All**.
A message pops up to confirm that you want to delete all the records.
3. Press the **OK** soft key.

To place a call from the call history via phone user interface:

1. Press the **History** soft key.
2. Highlight the desired entry.
3. Press the **Send** soft key.

Recent Call In Dialing

To view the placed calls list when the phone is on the dialing screen, you should enable recent call in dialing in advance.

To enable recent call in dialing via web user interface:

1. Click **Directory->Setting**.
2. Select **Enabled** from the pull-down list of **Recent Call In Dialing**.

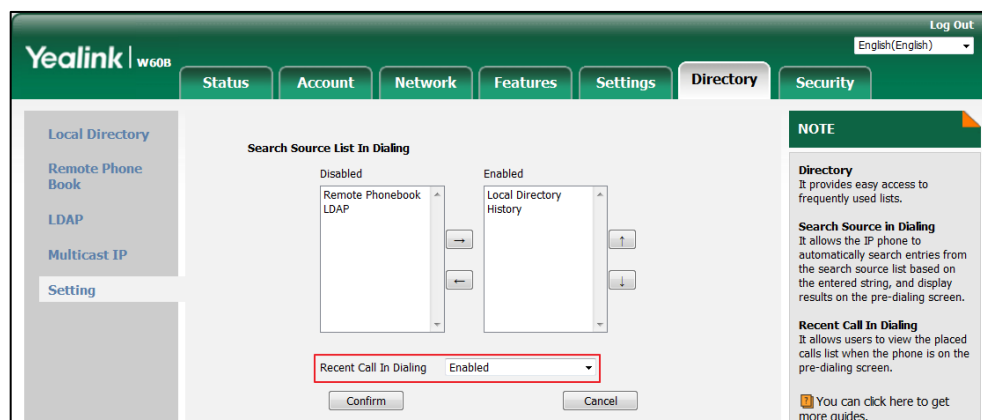

3. Click **Confirm**.

Dial Plan

Dial plan is a string of characters that governs the way your phone processes the inputs entered from your phone keypad. The phone supports the following dial plan features:

- [Replace Rule](#)

- [Dial Now](#)
- [Area Code](#)
- [Block Out](#)

Basic expression syntaxes you need to know:

.	The dot "." can be used as a placeholder or multiple placeholders for any character. Example: "12." would match "123", "1234", "12345", "12abc", etc.
x	An "x" can be used as a placeholder for any character. Example: "12x" would match "121", "122", "123", "12a", etc.
-	Numeric ranges are allowed within the brackets: Digit "-" Digit. Example: "[5-7]" would match the number "5", "6" or "7".
[]	The square brackets "[]" can be used as a placeholder for a single character which matches any of a set of characters. Example: "91[5-7]1234" would match "9151234", "9161234", "9171234", etc.
()	The parentheses "()" can be used to group together patterns, for instance, to logically combine two or more patterns. Example: "91([5-7])1(x)" would match "91511", "91618", "91715", etc.
\$	The "\$" followed by the sequence number of a parenthesis means the characters placed in the parenthesis. The sequence number stands for the corresponding parenthesis. Example: A replace rule configuration, Prefix: "001(xxx)45(xx)", Replace: "9001\$145\$2". When you dial out "0012354599" on your phone, the DD phone will replace the number with "9001 2354599 ". "\$1" means 3 digits in the first parenthesis, that is, "235". "\$2" means 2 digits in the second parenthesis, that is, "99".

Note

The DD phone supports a new dial plan mechanism - digit map. You can use one or more matching rules in one digit map string. If the new dial plan mechanism is enabled, old dial plan will be ignored. For more information, contact your system administrator.

Replace Rule

You can configure one or more replace rules (up to 100) to remove the specified string and replace it with another string. You can configure a pattern with wildcards (expression syntax refer to the table above), so that any string that matches the pattern will be replaced. This feature is convenient for you to dial out a long number.

To add a replace rule via web user interface:

1. Click **Settings->Dial Plan->Replace Rule**.
2. Enter the string in the **Prefix** field.
3. Enter the string in the **Replace** field.

- Enter the desired line ID in the **Account** field or leave it blank.

The screenshot shows the 'Replace Rule' configuration page in the Yealink W608 web interface. The page has a green header with 'Yealink W608' and a 'Log Out' button. Below the header are tabs for 'Status', 'Account', 'Network', 'Features', 'Settings', 'Directory', and 'Security'. The 'Settings' tab is active, and the 'Dial Plan' sub-tab is selected. A table with columns 'Index', 'Prefix', 'Replace', and 'Account' is shown, with 10 rows. Below the table are input fields for 'Prefix 1', 'Replace 104', and 'Account'. There are 'Add', 'Edit', and 'Del' buttons. A 'NOTE' section on the right explains the fields and provides a legend for special characters.

- Click **Add**.

When you enter the number "1" using the keypad and then dial out using the configured account, the phone will dial out "104" instead.

Note

The valid value of the "Account" parameter can be one or more digits among 1-8, each of which represents a line ID. Multiple digits must be separated by commas. For example, when you enter the value "1, 2" in the **Account** field, this dial plan rule will apply to account1 and account2.

If you leave the **Account** field blank or enter 0, this dial plan rule will apply to all accounts.

To edit a replace rule via web user interface:

- Click **Settings->Dial Plan->Replace Rule**.
- Select the desired replace rule by clicking the replace rule or checking the check box.
- Edit the value in the **Prefix** and **Replace** field respectively.
- Enter the desired line ID in the **Account** field or leave it blank.
- Click **Edit**.

To delete one or more replace rules via web user interface:

- Click **Settings->Dial Plan->Replace Rule**.
- Select one or more replace rules by clicking the replace rule(s) or checking the check box(es).
- Click **Delete**.

Note

Replace rule is configurable via web user interface only.

Replace rule is applicable to all DD phones registered to the base station.

Dial Now

You can configure one or more dial now rules (up to 100) on your DD phone. When the dialed number matches the dial now string, the number will be dialed out automatically.

To add a dial now rule via web user interface:

1. Click **Settings->Dial Plan->Dial Now**.
2. Enter the desired value (for example, 2xx) in the **Rule** field.
3. Enter the desired line ID in the **Account** field or leave it blank.

For more information on the valid values for the **Account** field, refer to [Replace Rule](#).

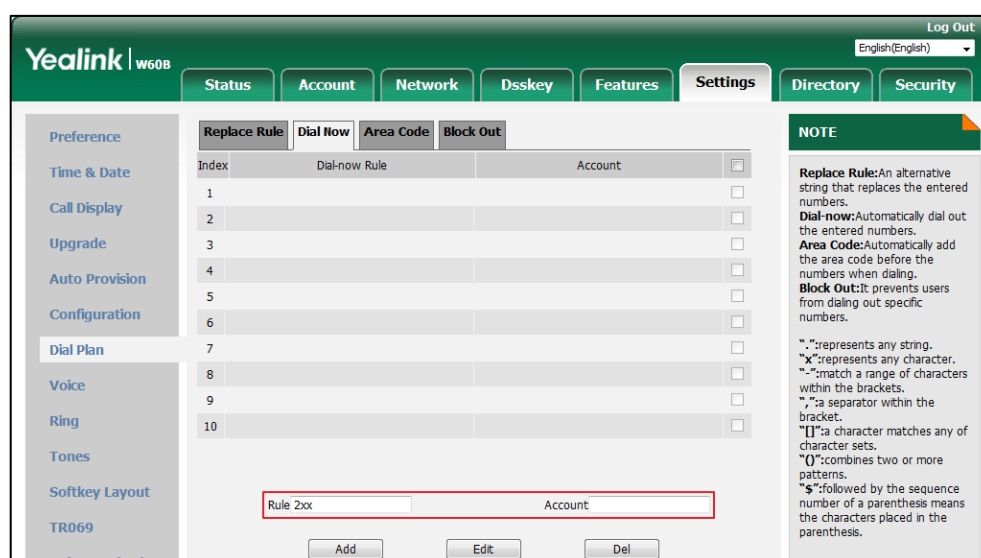

4. Click **Add** to add the dial now rule.

When you enter the number "234" using the keypad, the phone will dial out "234" automatically without the pressing of any key.

You can also edit or delete the dial now rule, refer to [Replace Rule](#) for more information.

Time Out for Dial Now Rule

You can configure the time out for dial now rules. That is, you can configure your phone to automatically dial out the phone number that matches a dial now rule, after the designated delay time.

To configure the time out for dial now rule via web user interface:

1. Click **Features->General Information**.

- Enter the time between 0 and 14 (seconds) in the **Time Out for Dial Now Rule** field.

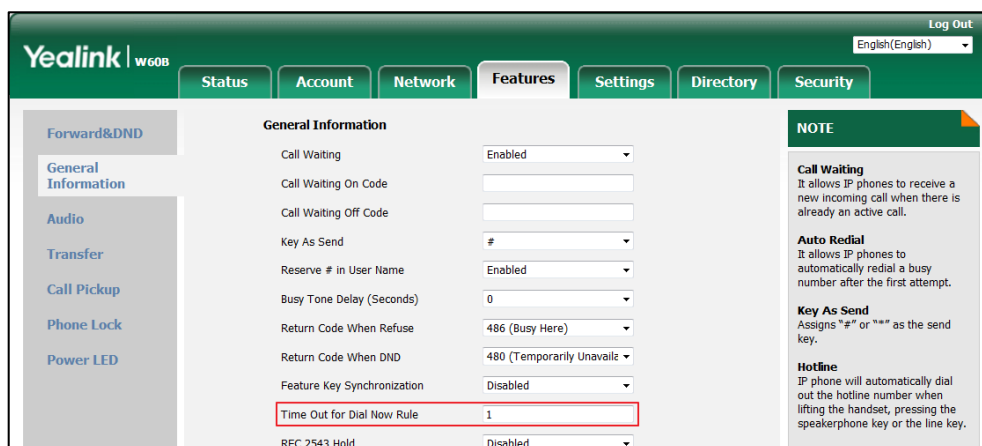

- Click **Confirm**.

Note Dial now rule and time out for dial now rule are configurable via web user interface only. Dial now rule is applicable for all DD phones registered to the base station.

Area Code

Area codes are also known as Numbering Plan Areas (NPAs). They usually indicate geographical areas in a country. This feature is necessary only when dialing the number outside the code area. You can only configure one area code rule on your phone.

To configure area code via web user interface via phone user interface:

- Click **Settings->Dial Plan->Area Code**.
- Enter the desired value in the **Code**, **Minimum Length (1-15)** and **Maximum Length (1-15)** field respectively.
- Enter the desired line ID in the **Account** field or leave it blank.

For more information on the valid values for the **Account** field, refer to [Replace Rule](#).

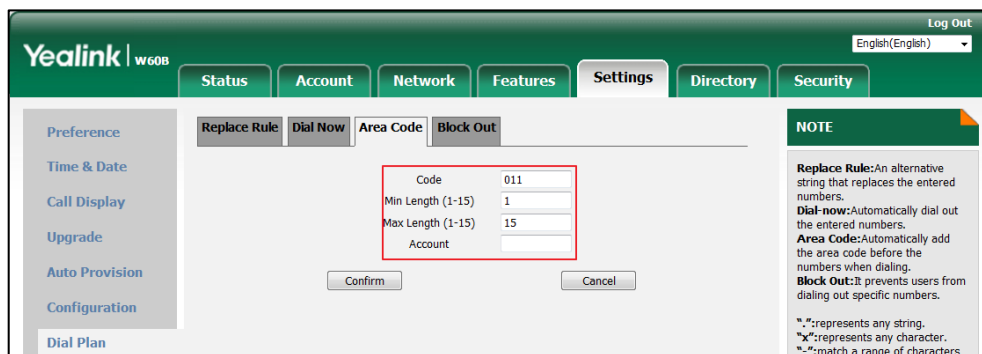

- Click **Confirm**.

For example, when you dial out the number "56789", as the length of the number is between 1 and

15, the phone will add the area code before the number and dial out (01156789).

Note The default values of the minimum and maximum lengths are 1 and 15.
Area code is configurable via web user interface only.
Area code is applicable to all DD phones registered to the base station.

Block Out

You can block some specific numbers (up to 10) from being dialed. When you dial the block out number on the DD phone, the dialing will fail.

To add a block out number via web user interface:

1. Click **Settings->Dial Plan->Block Out**.
2. Enter the desired value in the **BlockOut NumberX** field.
3. Enter the desired line ID in the **Account** field or leave it blank.

For more information on the valid values for the **Account** field, refer to [Replace Rule](#).

BlockOut Number	Value	Account
BlockOut Number1	103	Account
BlockOut Number2		Account
BlockOut Number3		Account
BlockOut Number4		Account
BlockOut Number5		Account
BlockOut Number6		Account
BlockOut Number7		Account
BlockOut Number8		Account
BlockOut Number9		Account
BlockOut Number10		Account

4. Click **Confirm**.

Note Block out is configurable via web user interface only.
Block out is applicable to all DD phones registered to the base station.

Emergency Numbers

Public telephone networks in countries around the world have a single emergency telephone number (emergency services number), typically a three-digit number, that allows a caller to contact local emergency services for assistance when necessary. The emergency telephone number may differ from country to country. Some countries have different emergency numbers for different emergency services.

You can specify the emergency numbers for contacting the emergency services in an emergency. You can dial these numbers even when the phone is locked. For more information on phone lock, refer to [Phone](#)

Lock.

Note

Contact your local phone service provider for available emergency numbers in your area.

The DD phone also supports the emergency dialplan, which allows users to make emergency calls if the phone is locked or unregistered. For more information, contact your system administrator.

To specify emergency numbers via web user interface:

1. Click **Features**->**Phone Lock**.
2. Enter the emergency services number in the **Emergency** field.

For multiple numbers, enter a comma between every two emergency numbers.

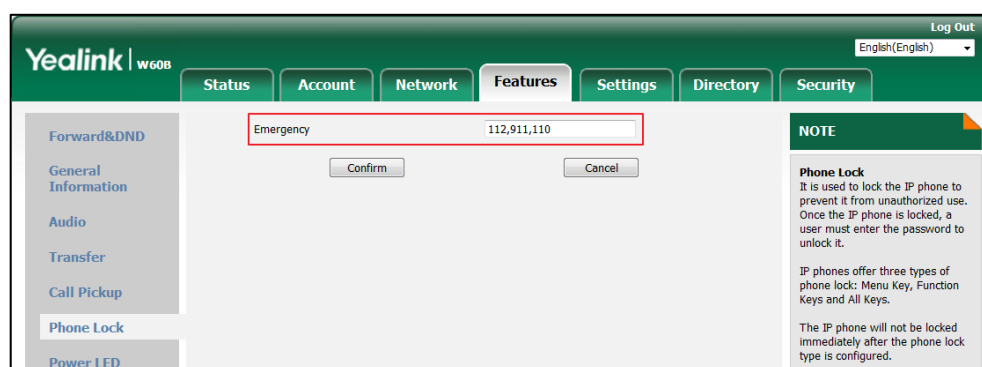

3. Click **Confirm**.

Outgoing Lines

After the DD phone is registered to the base station (refer to [Phone Registration](#)), you can assign one or more outgoing lines for the phone. The phone can only use the assigned outgoing line(s) to place calls. When multiple outgoing lines are assigned to the phone, the phone uses the first line as the default outgoing line. You can change the default outgoing line of the phone.

To assign outgoing line to phone via web user interface:

1. Click **Account**->**Number Assignment**.

2. Check the desired checkbox of the account from **Line No.&Name** field for the corresponding phone in the **Handset No.** field.

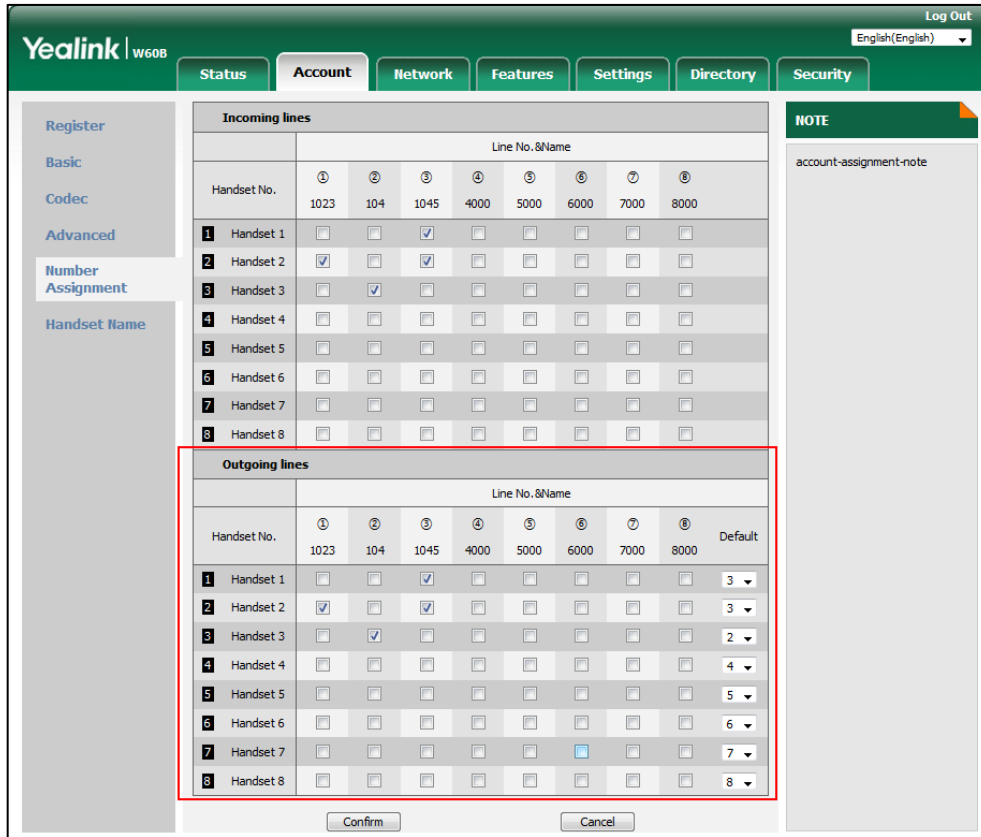

3. (Optional) Select the default outgoing line from the pull-down list of **Default**.
The default outgoing line is the first line you selected. You can only select the line number you have checked for the phone, or it will not take effect.
4. Click **Confirm**.

As the configuration shown above, you can do the following:

- For Handset1: Line 3 (1045) is assigned to Handset1, and it is the default outgoing line. You can only place a call using line 3 (1045).
- For Handset2: Line 1 (1023) and line 3 (1045) are assigned to Handset2, and the default outgoing line is line 3. You can place a call using line 1 (1023) or line 3 (1045).
- For Handset3: Line 2 (104) is assigned to Handset3, and it is the default outgoing line. You can only place a call using line 2 (104).
- Both Handset 1 and Handset 2 can place a call using the line 3 (1045) at the same time.

Incoming Lines

After the DD phone is registered to the base station (refer to [Phone Registration](#)), you can assign one or more incoming lines for the phone. The phone can only receive incoming calls on the assigned incoming

line(s). You can assign incoming lines to all DD phones registered to the same base station on your phone.

To assign incoming line to phone via web user interface:

1. Click **Account->Number Assignment**.
2. Check the desired checkbox of the account from **Line No.&Name** field for the corresponding phone in the **Handset No.** field.

Incoming lines		Line No. &Name							
Handset No.		①	②	③	④	⑤	⑥	⑦	⑧
		1023	104	1045	4000	5000	6000	7000	8000
1	Handset 1	<input type="checkbox"/>	<input type="checkbox"/>	<input checked="" type="checkbox"/>	<input type="checkbox"/>	<input type="checkbox"/>	<input type="checkbox"/>	<input type="checkbox"/>	<input type="checkbox"/>
2	Handset 2	<input checked="" type="checkbox"/>	<input type="checkbox"/>	<input checked="" type="checkbox"/>	<input type="checkbox"/>	<input type="checkbox"/>	<input type="checkbox"/>	<input type="checkbox"/>	<input type="checkbox"/>
3	Handset 3	<input type="checkbox"/>	<input checked="" type="checkbox"/>	<input type="checkbox"/>	<input type="checkbox"/>	<input type="checkbox"/>	<input type="checkbox"/>	<input type="checkbox"/>	<input type="checkbox"/>
4	Handset 4	<input type="checkbox"/>	<input type="checkbox"/>	<input type="checkbox"/>	<input type="checkbox"/>	<input type="checkbox"/>	<input type="checkbox"/>	<input type="checkbox"/>	<input type="checkbox"/>
5	Handset 5	<input type="checkbox"/>	<input type="checkbox"/>	<input type="checkbox"/>	<input type="checkbox"/>	<input type="checkbox"/>	<input type="checkbox"/>	<input type="checkbox"/>	<input type="checkbox"/>
6	Handset 6	<input type="checkbox"/>	<input type="checkbox"/>	<input type="checkbox"/>	<input type="checkbox"/>	<input type="checkbox"/>	<input type="checkbox"/>	<input type="checkbox"/>	<input type="checkbox"/>
7	Handset 7	<input type="checkbox"/>	<input type="checkbox"/>	<input type="checkbox"/>	<input type="checkbox"/>	<input type="checkbox"/>	<input type="checkbox"/>	<input type="checkbox"/>	<input type="checkbox"/>
8	Handset 8	<input type="checkbox"/>	<input type="checkbox"/>	<input type="checkbox"/>	<input type="checkbox"/>	<input type="checkbox"/>	<input type="checkbox"/>	<input type="checkbox"/>	<input type="checkbox"/>

Outgoing lines		Line No. &Name								
Handset No.		①	②	③	④	⑤	⑥	⑦	⑧	Default
		1023	104	1045	4000	5000	6000	7000	8000	
1	Handset 1	<input type="checkbox"/>	<input type="checkbox"/>	<input checked="" type="checkbox"/>	<input type="checkbox"/>	<input type="checkbox"/>	<input type="checkbox"/>	<input type="checkbox"/>	<input type="checkbox"/>	3
2	Handset 2	<input checked="" type="checkbox"/>	<input type="checkbox"/>	<input checked="" type="checkbox"/>	<input type="checkbox"/>	<input type="checkbox"/>	<input type="checkbox"/>	<input type="checkbox"/>	<input type="checkbox"/>	3
3	Handset 3	<input type="checkbox"/>	<input checked="" type="checkbox"/>	<input type="checkbox"/>	<input type="checkbox"/>	<input type="checkbox"/>	<input type="checkbox"/>	<input type="checkbox"/>	<input type="checkbox"/>	2
4	Handset 4	<input type="checkbox"/>	<input type="checkbox"/>	<input type="checkbox"/>	<input type="checkbox"/>	<input type="checkbox"/>	<input type="checkbox"/>	<input type="checkbox"/>	<input type="checkbox"/>	4
5	Handset 5	<input type="checkbox"/>	<input type="checkbox"/>	<input type="checkbox"/>	<input type="checkbox"/>	<input type="checkbox"/>	<input type="checkbox"/>	<input type="checkbox"/>	<input type="checkbox"/>	5
6	Handset 6	<input type="checkbox"/>	<input type="checkbox"/>	<input type="checkbox"/>	<input type="checkbox"/>	<input type="checkbox"/>	<input type="checkbox"/>	<input type="checkbox"/>	<input type="checkbox"/>	6
7	Handset 7	<input type="checkbox"/>	<input type="checkbox"/>	<input type="checkbox"/>	<input type="checkbox"/>	<input type="checkbox"/>	<input type="checkbox"/>	<input type="checkbox"/>	<input type="checkbox"/>	7
8	Handset 8	<input type="checkbox"/>	<input type="checkbox"/>	<input type="checkbox"/>	<input type="checkbox"/>	<input type="checkbox"/>	<input type="checkbox"/>	<input type="checkbox"/>	<input type="checkbox"/>	8

3. Click **Confirm**.

As the configuration shown above, you can do the following:

- For Line 1: Line 1 (1023) is assigned to Handset2. A call to line 1 (1023) will be received by Handset2.
- For Line 2: Line 2 (104) is assigned to Handset3. A call to line 2 (104) will be received by Handset3.
- For Line 3: Line 3 (1045) is assigned to Handset1 and Handset2. A call to line 3 (1045) will be received by Handset1 or Handset2. Two DD phones ring simultaneously, but the incoming call can be only answered by one of them.

To assign incoming line to phone via phone user interface:

1. Press **Menu->Settings->Advanced Settings** (default password: 0000) ->**Incoming Lines**.
The LCD screen displays all DD phones registered to the base station.
2. Select the desired phone.
3. Select the desired line.

4. Select **Accept** from the desired line field.
5. Press the **Save** soft key.

Key As Send

You can set the “#” key or “*” key to perform as a send key while dialing.

To configure key as send via web user interface:

1. Click **Features->General Information**.
2. Select the desired value from the pull-down list of **Key As Send**.

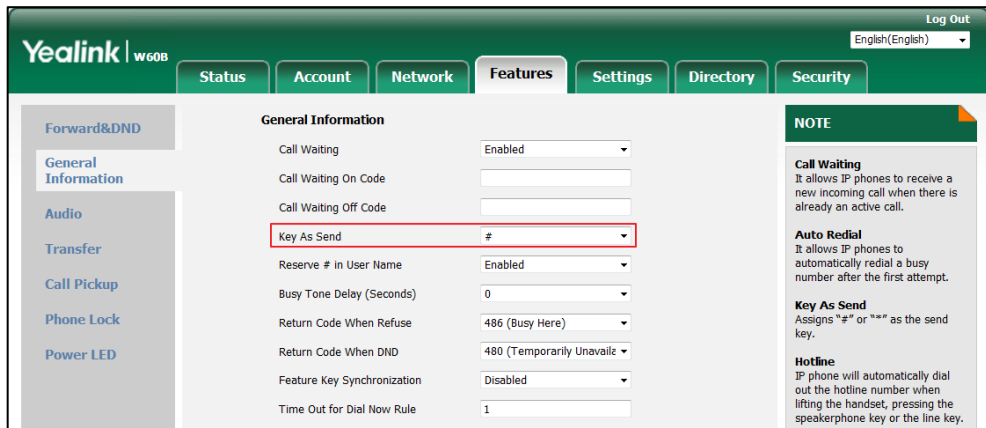

3. Click **Confirm**.

Speed Dial

Speed dial allows you to speed up dialing the numbers that is frequently used or hard to remember. You can set a line key/soft key/programmable key as a Speed Dial key for a contact number. This chapter takes line key as an example.

Configuring a Speed Dial Key

To configure a speed dial key via phone user interface:

1. Press **Menu->Features->DSS Keys**.
2. Select the desired line key, and then press the **Enter** soft key.
3. Select the **SpeedDial** from the **Type** field.
4. Select the desired line from the **Account ID** field.

The phone will use the selected account to dial out the number when you press the Speed Dial key.

5. (Optional) Enter the string that will appear on the LCD screen in the **Label** field.
6. Enter the number you want to dial out in the **Value** field.

Placing a Call Using Speed Dial Key

To place a call using the speed dial key via phone user interface:

1. Press the Speed Dial key when the phone is idle.

Base Reboot

In some instances, you may need to reboot the base station to refresh the settings.

To reboot the base station via phone user interface:

1. Press **Menu->Settings->Advanced Settings** (default password: 0000) ->**Reboot Config->Base Reboot**.

A message pops up to confirm that you want to reboot the base.

2. Press the **OK** soft key.

The registration LED and network status LED on the base station go out simultaneously. After a period of time, the LED indicators will glow green again when the base station restarts successfully.

Base reboot is also configurable via the web user interface at the path **Settings->Upgrade**.

Phone Reboot

In some instances, you may need to reboot the DD phone to refresh the settings.

To reboot the phone via phone user interface:

1. Press **Menu->Settings->Advanced Settings** (default password: 0000) ->**Reboot Config->Handset Reboot**.

A message pops up to confirm that you want to reboot the phone.

2. Press the **OK** soft key.

The phone begins rebooting. Any reboot of the phone may take a few minutes.

Base PIN (Administrator Password)

To avoid unauthorized registration or access to some features on the DD phone, you should keep the base PIN (administrator password) secret.

To change the base PIN via phone user interface:

1. Press **Menu->Settings->Advanced Settings** (default password: 0000) ->**Change Password**.
2. Enter the current PIN (default: 0000) in the **Old PWD** field.
3. Enter the new PIN in the **New PWD** field.
4. Re-enter the new PIN in the **Confirm PWD** field.

5. Press the **Save** soft key.

Base PIN is also configurable via web user interface at the path **Security->Base PIN**.

Note We recommend you to set the new PIN in random and cannot be easily guessed.

Base Reset

You can reset the base station to factory settings. This will clear all individual settings of the base station (for example, directory, and account registrations). Phone registrations and the base PIN will not be reset to factory defaults. Consult your system administrator for advice before resetting the base station.

To reset the base station via phone user interface:

1. Press **Menu->Settings->Advanced Settings** (default password: 0000) ->**Reset Config->Reset base settings**.

A message pops up to confirm that you want to reset the base to factory defaults.

2. Press the **OK** soft key.

All individual settings of the base station will be reset to factory defaults. The power LED indicator and network status LED on the base station slowly flash in sequence during the resetting. LED indicators on the base station glow green after startup.

Base reset is also configurable via the web user interface at the path **Settings->Upgrade**.

Note Base reset may take a few minutes. Do not power off until the base station starts up successfully.

Phone Reset

You can reset individual settings that you have configured on the DD phone. Resetting phone will not overwrite settings of directory, call history, voice mail, and the phone registration to the base station. Other customized settings on the phone will be reset to factory settings after phone reset. Consult your system administrator for advice before resetting the phone.

To reset the phone via phone user interface:

1. Press **Menu->Settings->Advanced Settings** (default password: 0000) ->**Reset Config->Reset handset settings**.

A message pops up to confirm that you want to reset the phone to factory defaults.

2. Press the **OK** soft key.

Note The settings configured for the dongle will also be reset to factory settings when performing phone reset.

Auto Provision

You can trigger the auto provisioning using the wizard. After you enter the user name and password in the wizard and confirm to perform an update, the base station tries to connect to the RPS (Redirection and Provisioning Service) server. If the base station successfully connects the RPS server, the RPS server will respond the base station with the URL for downloading the configuration files. Then the base station will try to perform auto provisioning. Contact your system administrator for the user name and password used to connect to the RPS server.

To trigger the auto provisioning process via phone user interface:

1. Press **Menu**->**Settings**->**Advanced Settings** (default password: 0000) ->**RPS**.
2. Enter the user name in the **User Name** field.
3. Enter the password in the **Password** field.
4. Press the **Save** soft key.

A message pops up to confirm that you want to perform an update now.

5. Press the **OK** soft key.

Call Features

This chapter provides operating instructions of the call features.

Topics include:

- [Placing Calls](#)
- [Answering Calls](#)
- [Ending Calls](#)
- [Redialing Calls](#)
- [Call Mute](#)
- [Call Hold/Resume](#)
- [Call Waiting](#)
- [Do Not Disturb \(DND\)](#)
- [Call Forward](#)
- [Call Transfer](#)
- [Conference Call](#)
- [Call Park](#)
- [Anonymous Call](#)
- [Anonymous Call Rejection](#)
- [Voice Mail](#)
- [Shared Call Appearance \(SCA\)](#)
- [Multicast Paging](#)

Placing Calls

When the DD phone is registered to the base station successfully, you can use your phone to place an internal or external call. One phone can handle a maximum of two calls at one time. However, only one active call (the call that has audio associated with it) can be in progress at any time, the other call is placed on hold.

Note The base station can handle multiple calls (4 calls by default) at a time when multiple DD phones are registered. For more information, contact your system administrator.

You can place a call using the following ways:

- Using the handset
- Using the speakerphone

- Using the headset

During a call, you can alternate among Speakerphone, Headset, or Handset mode by pressing the Speakerphone key, the Headset key, or by picking up the handset.

The call duration and far-site's information (name or phone number) are visible on the LCD screen.

Placing Internal Calls

You can make free internal calls between the DD phones/handsets registered to the same base station.

You can place an internal call to one DD phone or all phones registered to the same base station.

Note The phone/handset must be subscribed and registered to the same base station to place a call. For more information on registration, refer to [Phone Registration](#).

To place an internal call to one DD phone:

1. Do one of the following:

- Press **Menu->Intercom**.
- Pick up the handset. Then press the **Intercom** soft key.

The LCD screen displays all registered phone names and the **All phone** option.

2. Highlight the desired phone name.
3. Press the **OK** soft key.

The corresponding DD phone will ring.

To place an internal call to all phones:

1. Press **Menu->Intercom**.

The LCD screen displays all registered phone names and the **All phone** option.

2. Highlight **All phone**.
3. Press the **OK** soft key.

All other subscribed phones will ring simultaneously.

Placing External Calls

You can place external calls on the DD phone. External calls based on the public telephone network require the use of SIP lines. Your system administrator needs to assign the SIP line to the phone beforehand, and then assign the line to the phone as the outgoing line. For more information on the outgoing line, refer to [Outgoing Lines](#).

To place an external call:

1. Do one of the following:

- Enter a phone number.

- Pick up the handset, press the Speakerphone key, or the HEADSET key. Then enter a number or select a contact.

If multiple lines are assigned to your phone as outgoing lines, press the **Line** soft key to select the desired line.

If you do not select a line, the phone uses the default outgoing line to dial.

2. Press the **Send** soft key.

You can place at most two calls on your DD phone. You can also place an internal call during an external call.

To place a new external call during an active call:

1. Press the **Hold** soft key to place the original call on hold.
2. Press the **New Call** soft key.
3. Enter the desired number, or press the **Directory** soft key to select a contact.
4. press the **Send** soft key

To place an internal call during an active call:

1. Press the **Hold** soft key to place the original call on hold.
2. Press the **New Call** soft key.
3. Press the **Intercom** soft key to select a phone.
4. Press the **OK** soft key.

Answering Calls

When the DD phone is registered to the base station successfully, you can answer a call in three ways:

- Using the handset
- Using the speakerphone
- Using the headset

Note

You can reject incoming calls by pressing the **X** key or the **Reject** soft key.

You can also activate Do Not Disturb mode on a per-line basis to reject all incoming calls of the specified line. For more information, refer to [Do Not Disturb \(DND\)](#).

Answering When Not in Another Call

In all cases, the active call will appear on the LCD screen showing call duration and destination.

To answer a call using the handset:

1. Pick up the handset.

To answer a call using the hands-free speakerphone mode:

1. Press .

With the handset on-hook and headset mode deactivated, you can press the **Answer** soft key or the line key on which receives an incoming call.

To answer a call using the headset:

1. Press .

With the headset mode activated, you can press the **Answer** soft key or the line key on which receives an incoming call.

Answering When in Another Call:

If you are during an active call, an incoming call arrives on the phone, do the following:





1. Press the **Answer** soft key.

The incoming call is answered, and the original call is placed on hold.



Ending Calls

To end a call:

Do one of the following:

- If you are using the handset, press , the **End Call** soft key or hang up the handset.
- If you are using the headset, press  or the **End Call** soft key.
- If you are using the speakerphone, press ,  or the **End Call** soft key.

Note

When a call is placed on hold, you cannot press  to end it. You should press the **Resume** soft key to resume the call, and then press  to end it.

Redialing Calls

The redial number list stores the last eighteen dialed phone numbers. When the memory of the redial number list is full, the DD phone will automatically erase the oldest one when a new number is dialed. You can redial a call from the redial number list.

To redial the last dialed number:

1. Press  twice.

A call to your last dialed number is attempted.

To redial a previously dialed number:

1. Press  when the phone is idle to access the redial number list.
2. Select the desired entry from the redial number list.

3. Press  or the **Send** soft key.

To delete an entry from the redial number list:

1. Press  when the phone is idle to access the redial number list.
2. Highlight the desired entry.
3. Press the **Delete** soft key.



To delete all entries from the redial number list:

1. Press  when the phone is idle to access the redial number list.
2. Highlight the desired entry.
3. Press the **Del All** soft key.



Call Mute

You can mute the microphone during an active call. So that, you can hear the other party but he or she cannot hear you. For example, if you do not want the other party to listen to the conversation when you talk to someone in the room, you can mute the microphone temporarily.

To mute a call:

1. Press  during an active call.
The mute key LED glows red, and the icon  is displayed on the LCD screen.

To un-mute a call:

1. Press  again.
The mute key LED goes out, and the icon  disappears from the LCD screen.

Call Hold/Resume

You can place an active call on hold. At any time, at most one active call can be in progress on your phone. You can answer or make another call while placing the original call on hold.

To place a call on hold:



1. Press the **Hold** soft key during a call.
The line key LED flashes green, and the icon  is displayed on the LCD screen.

To resume a held call:

1. Press the **Resume** soft key.

Two calls on Hold:

If two calls are placed on hold, do one of the following:

- Press  or  to switch between the calls, and then press the **Resume** soft key to retrieve the

desired call.

- Press the corresponding line key to retrieve the call.

Call Waiting

Call waiting allows you to receive another call when there is already an active call on your phone. If it is disabled, the new incoming call will be rejected automatically.

You can enable call waiting feature to avoid missing important calls during a call. You can also set the phone to play a warning tone when the new incoming call arrives.

To configure call waiting feature via phone user interface:

1. Press **Menu->Features->Call Waiting**.
2. Select **Enabled** from the **Call Waiting** field.
3. Select **Enabled** from the **Play Tone** field.
4. Press the **Save** soft key.

Note The call waiting tone works only if call waiting feature is enabled.

Do Not Disturb (DND)

You can activate or deactivate DND on a per-line basis. If DND is activated for a specific line, all incoming calls to this line will be rejected automatically, and the callers will hear a busy tone.

Note The DND feature takes effect on the incoming lines that assigned to the DD phone. For more information on assigning incoming lines, refer to [Incoming Lines](#). If only one incoming line is assigned to the phone, press the **DND** soft key when the phone is idle to activate DND.

To activate DND via phone user interface:

1. Press **Menu->Features->DND**.
The LCD screen displays the incoming lines currently assigned to the phone.
2. You can activate DND for a specific line:
 - 1) Select the desired line.
 - 2) Select **Enabled** from the **DND Status** field.

You can also activate DND for all lines:

- 1) Do one of the following:
 - Press the **All On** soft key.
 - After DND was activated for a specific line on the step 2, press the **All Lines** soft key. A message pops up to confirm that you want to copy this setting to all lines.

Press the **OK** soft key

3. Press the **Save** soft key.

The associated line icon will change to  , and the icon **DND** will appear in the status bar.

The phone will reject all incoming calls to this line, and the LCD screen will display the missed call icon  in the status bar. The prompt message "n New Missed Call(s)" ("n" indicates the number of missed calls, for example, 3 New Missed Call(s)) will also appear on the LCD screen.

DND is configurable via web user interface at the path **Features->Forward&DND**.

Call Forward

You can enable call forward feature on a per-line basis. The DD phone will forward incoming calls of the line to another party.

Three forwarding types:

- **Always Forward:** Forward all incoming calls in any case.
- **Busy Forward:** Forward incoming calls if the line is busy.
- **No Answer Forward:** Forwards incoming calls if they are not answered after a period of time.

Note

The call forward feature takes effect on the incoming lines that assigned to the DD phone. For more information on assigning incoming lines, refer to [Incoming Lines](#).

To activate call forward via phone user interface:

1. Press **Menu->Features->Call Forward**.

The LCD screen displays the incoming lines currently assigned to the phone.



2. You can activate call forward for a specific line:
 - 1) Select the desired line.
 - 2) Select a desired forward type.
 - 3) Select **Enabled** from the **Always Forward/Busy Forward/No Answer Forward** field.
 - 4) Enter the number you want to forward incoming calls to in the **Forward to** field.
 - 5) For no answer forward, select the ringing time the phone to wait before forwarding from the **After Ring Time** field.
 - 6) Press the **Save** soft key.

You can also activate call forward for all lines. After always forward/busy forward/no answer forward was enabled for a specific line, do the following:

- 1) Highlight the **Always Forward/Busy Forward/No Answer Forward** field.
- 2) Press the **All Lines** soft key.

A message pops up to confirm that you want to copy this setting to all lines.

- 3) Press the **OK** soft key.

The associated line icon will change to  , and the icon  will appear in the status bar.

If Always Forward is selected, there is no prompts display on the LCD screen when the line receives an incoming call. The incoming call is logged in the call history list.

Call forward is configurable via web user interface at the path **Features->Forward&DND**.

Note

Call forward feature may be overridden by the server settings. For more information, contact your system administrator.

Call Transfer



You can transfer an incoming call to another party in one of the following ways:

- **Blind Transfer:** Transfer a call directly to another party without consulting.
- **Semi-Attended Transfer:** Transfer a call when receiving the ring-back.
- **Attended Transfer (Consultative Transfer):** Transfer a call with prior consulting.

To perform a blind transfer:

1. Press the **Transfer** soft key.
2. Do one of the following:
 - Enter the number you want to transfer the call to.
 - To transfer the call to an internal number, press the **Intercom** soft key, and then select the desired DD phone.
3. Press the **B Trans** soft key to complete the transfer.

To perform a semi-attended/attended transfer:

1. Press the **Transfer** soft key.
2. Do one of the following:
 - Enter the number you want to transfer the call to.
 - To transfer the call to an external number, press the **Directory** soft key, and then select the desired contact.
 - To transfer the call to an internal number, press the **Intercom** soft key, and then select the desired DD phone.
3. Press  ,  or the **Send** soft key to dial out.
4. Do one of the following:
 - When you hear the ringback tone, press the **Transfer** soft key to finish a semi-attended transfer.
 - After the contact answers the call, press the **Transfer** soft key to finish an attended transfer.

Note

If you are using a handset, the transfer can be completed by hanging up the handset.

To transfer a call to another party when there are two calls on the phone:

1. Place a call to user A.
2. Place another call to user B using the same line.
Two calls are established on the phone.
3. Select the desired call (for example, the call with user A).
4. Press the **Transfer** soft key.
5. Select **New Call** to transfer the call to a desired number, or select the target party (for example, user B).

The phone returns to the idle screen. Call is established between user A and user B.

Conference Call

You can set up a local conference with other two parties. The DD phone also supports network conference.



Note



Network conference is not available on all servers. For more information, contact your system administrator.

Local Conference

You can use the DD phone to create a local conference with other parties. Up to three parties (including yourself) can be involved in a conference call. You can create a conference with an active call and a held call on the phone (on the same line or different lines).

To set up a local conference call:

1. Place a call to the first party.
2. When the first party answers the call, press the **Conf** soft key to place a new call.
The active call is placed on hold.
3. Enter the number of the second party and then press , , or the **Send** soft key.
4. When the second party answers the call, press the **Conf** soft key again to join all parties in the conference.

You can press  or  to see all parties in the conference.

To join two calls in a conference:

1. Place two calls on the phone.
2. Select the call for conference and ensure that the call is active.
3. Press the **Conf** soft key to join the two calls in the conference.

Network Conference

You can use network conference feature to conduct a conference with multiple parties. The maximum number of the parties depends on the server.

To use this feature, you need to configure the network conference URI and conference type in advance. Contact your system administrator for the conference URI.

To configure network conference feature via web user interface:



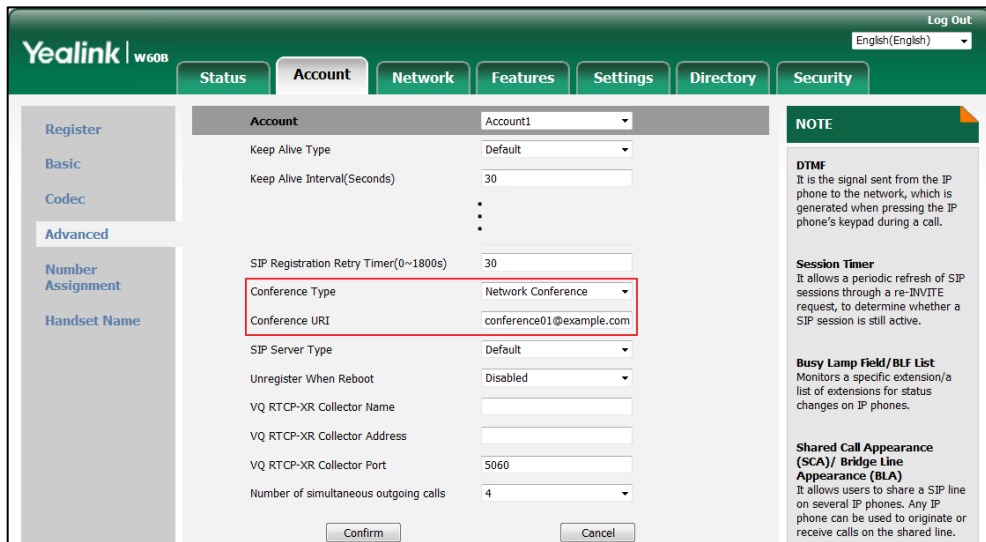

1. Click **Account**->**Advanced**.
2. Select the desired account from the pull-down list of **Account**.
3. Select **Network Conference** from the pull-down list of **Conference Type**.
4. Enter the conference URI (for example, conference01@example.com) in the **Conference URI** field.



5. Click **Confirm**.

Note Network conference is only configurable via web user interface.

To set up a network conference call:

1. Place a call to the first party.
2. Press the **Conf** soft key to place a new call.
The active call is placed on hold.
3. Enter the number of the second party and then press  ,  , or the **Send** soft key.
4. When the second party answers the call, press the **Conf** soft key to add the second party to the conference.
5. Press the **Conf** soft key to place a new call.
The conference is placed on hold.
6. Enter the number of the new party and then press  ,  , or the **Send** soft key.

7. When the new party answers the call, press the **Conf** soft key to add the new party to the conference.
8. Repeat steps 5 to 7 until you have added all intended parties.

How to set up a network conference call on specific servers may be different from introduced above. Contact your system administrator for more information.

Call Park

You can use call park feature to place a call on hold, and then retrieve the call from another phone in the system (for example, a phone in another office or conference room). If the parked call is not retrieved within a period of time defined by the system, the phone performing call park will receive the call back.

Note Call park is not available on all servers. Contact your system administrator for more information.

The phone supports call park feature under the following modes:

- **FAC mode:** park the call to the local extension or a desired extension through dialing the park code.
- **Transfer mode:** park the call to the shared parking lot through performing a blind transfer. For some servers, the system will return a specific retrieve park number (park retrieve code) from which the call can be retrieved after being parked successfully.

You may need to configure the call park code and park retrieve code before using call park feature. You should configure a park retrieve key before using call park feature.

To configure a park retrieve key via phone user interface:

1. Press **Menu->Features->DSS Keys**.
2. Select the desired line key, and then press the **Enter** soft key.
3. Select the **Retrieve Park** from the **Type** field.
4. Select the desired line from the **Account ID** field.
5. (Optional) Enter the string that will appear on the LCD screen in the **Label** field.
6. Press the **Save** soft key.

Note The call park code and park retrieve code are predefined on the system server. Contact your system administrator for more information.

FAC Mode

To configure call park feature in FAC mode via web user interface:

1. Click **Features->Call Pickup**.
2. Select **FAC** from the pull-down list of **Call Park Mode**.
3. Select **Enabled** from the pull-down list of **Call Park**.

If **Enabled** is selected, the **Park** soft key will display on the LCD screen during a call.

4. (Optional) Enter the call park code in the **Call Park Code** field.

It is configured for the **Park** soft key.

5. (Optional) Enter the park retrieve code in the **Park Retrieve Code** field.

It is configured for the park retrieve key.

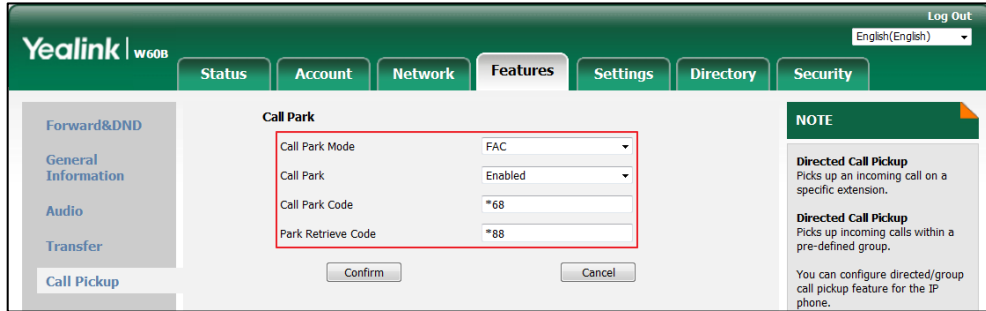

6. Click **Confirm**.

To park a call in FAC mode:

1. During a call, press the **Park** soft key (You may need to press the **More** soft key to see the **Park** soft key).

The phone will dial the configured call park code.

2. Do one of the following:

- a) If you want to park the call against the local extension, press  .

If the call is parked successfully, you will hear a voice prompt to confirm that the call is parked.

- b) If you want to park the call against desired extension, enter an extension (for example, 4603) where you want to park the call, and then press  .

If the call is parked successfully, you will hear a voice prompt to confirm that the call is parked.

The call is parked against the extension you entered.

To retrieve a parked call in FAC mode:

1. Press the retrieve park key on the phone.

The phone will dial the configured park retrieve code.

2. Follow the voice prompt, do one of the following:

- Press  on the phone where the call is parked.
- Enter the desired extension followed by # (for example, 4603#) on any phone.

Transfer Mode

To configure call park feature in transfer mode via web user interface:

1. Click **Features->Call Pickup**.
2. Select **Transfer** from the pull-down list of **Call Park Mode**.

3. Select **Enabled** from the pull-down list of **Call Park**.
If **Enabled** is selected, the **Park** soft key will display on the LCD screen during a call.
4. (Optional) Enter the call park code in the **Call Park Code** field.
It is configured for the **Park** soft key.
5. (Optional) Enter the park retrieve code in the **Park Retrieve Code** field.
It is configured for the park retrieve key.

The screenshot shows the Yealink W608 web interface. The 'Features' tab is selected, and the 'Call Park' configuration page is displayed. The 'Call Park Mode' is set to 'Transfer', 'Call Park' is 'Enabled', 'Call Park Code' is '*01', and 'Park Retrieve Code' is '*11'. There are 'Confirm' and 'Cancel' buttons at the bottom. A 'NOTE' section on the right explains 'Directed Call Pickup'.

6. Click **Confirm**.

To park a call in Transfer mode:

1. During a call, press the **Park** soft key (You may need to press the **More** soft key first).
The call will be directly transferred to the shared parking lot.

To retrieve a parked call in Transfer mode:

1. Press the retrieve park key on the phone.
The phone will retrieve the parked call from the shared parking lot.

Anonymous Call

You can use anonymous call feature to block the identity and phone number from showing up to the called party when you call someone. For example, you want to call a consultancy, but do not want to be harassed after that. You can configure anonymous call feature on a per-line basis.

Note The anonymous call feature takes effect on the outgoing lines that assigned to the DD phone. For more information on assigning outgoing lines, refer to [Outgoing Lines](#).
The anonymous call feature is not available on all servers. Contact your system administrator for more information.

To configure anonymous call feature for a specific line via phone user interface:

1. Press **Menu->Features->Anonymous Call**.
2. Select the desired line from the **Line ID** field.
All outgoing lines currently assigned to the phone can be selected.
3. Select **Enabled** from the **Local Anonymous** field.

4. Press the **Save** soft key.

Anonymous call is configurable via web user interface at the path **Account->Basic**.

To place an anonymous call:

1. Use the specific line on the phone to place a call.
The destination phone prompts an incoming call from anonymous.

Anonymous Call Code

You can configure the phone to send anonymous call on code/off code to activate/deactivate the server-side anonymous call feature via web user interface. Contact your system administrator for the anonymous call on code and off code.

To configure anonymous call code via web user interface:

1. Click **Account->Basic**.
2. Select the desired account from the **Account** field.
3. Select the desired value from the pull-down list of **Send Anonymous Code**.
The phone will send the configured on code or off code depending on your selection when you enable or disable anonymous call feature on the phone.
4. Enter the anonymous call on code and off code in the **On Code** and **Off Code** field respectively.

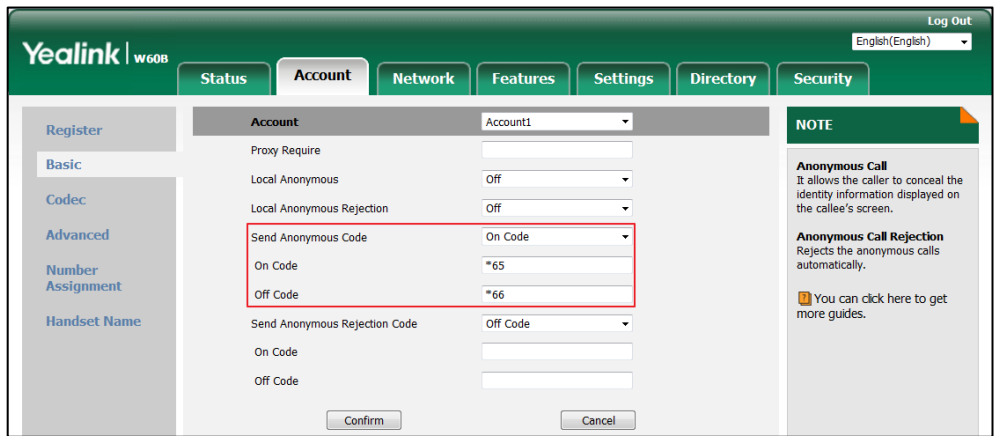

5. Click **Confirm**.

Anonymous Call Rejection

You can use anonymous call rejection feature to reject incoming calls from anonymous callers. Anonymous call rejection automatically rejects incoming calls from callers who deliberately block their identities and numbers from showing up. You can configure anonymous call rejection feature on a per-line basis.

Note The anonymous call rejection feature takes effect on the incoming lines that assigned to the DD phone. For more information on assigning incoming lines, refer to [Incoming Lines](#).
The anonymous call rejection feature is not available on all servers. Contact your system administrator for more information.

To configure anonymous call rejection feature for a specific line via phone user interface:

1. Press **Menu->Features->Anonymous Call**.
2. Select the desired line from the **Line ID** field.
3. Select **Enabled** from the **Local Anonymous Rejection** field.
4. Press the **Save** soft key.

Anonymous call rejection is configurable via web user interface at the path **Account->Basic**.

Anonymous Call Rejection Code

You can configure the phone to send anonymous call rejection on code/off code to activate/deactivate the server-side anonymous call rejection feature via web user interface. Contact your system administrator for the anonymous call rejection on code and off code.

To configure anonymous call rejection code via web user interface:

1. Click **Account->Basic**.
2. Select the desired account from the **Account** field.
3. Select the desired value from the pull-down list of **Send Anonymous Rejection Code**.

The phone will send the configured on code or off code depending on your selection when you enable or disable anonymous rejection call feature on the phone.

4. Enter the anonymous call rejection on code and off code in the **On Code** and **Off Code** field respectively.

The screenshot shows the Yealink W608 web user interface. The top navigation bar includes 'Status', 'Account', 'Network', 'Features', 'Settings', 'Directory', and 'Security'. The 'Account' tab is selected, and the 'Basic' sub-tab is active. The 'Account' field is set to 'Account1'. The configuration table is as follows:

Proxy Require	<input type="text"/>
Local Anonymous	Off
Local Anonymous Rejection	Off
Send Anonymous Code	On Code
On Code	*65
Off Code	*66
Send Anonymous Rejection Code	On Code
On Code	*67
Off Code	*68

At the bottom of the form are 'Confirm' and 'Cancel' buttons. A 'NOTE' box on the right explains the 'Anonymous Call' and 'Anonymous Call Rejection' features.

5. Click **Confirm**.

Voice Mail

You can leave voice mails to someone else. You can also receive and listen to voice mails via phone user interface. Voice mail feature ensures that you will never miss any important messages. When receiving a new voice mail, the icon  appears on the LCD screen with the number of unread voice mails, and the power LED slowly flashes red.

Note Voice mail feature is not available on all servers. Contact your system administrator for more information.

Voice Mail Tone

You can enable or disable the phone to play a warning tone when receiving a voice mail. Voice mail tone is enabled by default.

To configure the voice mail tone via web user interface:

1. Click **Features->General Information**.
2. Select the desired value from the pull-down list of **Voice Mail Tone**.

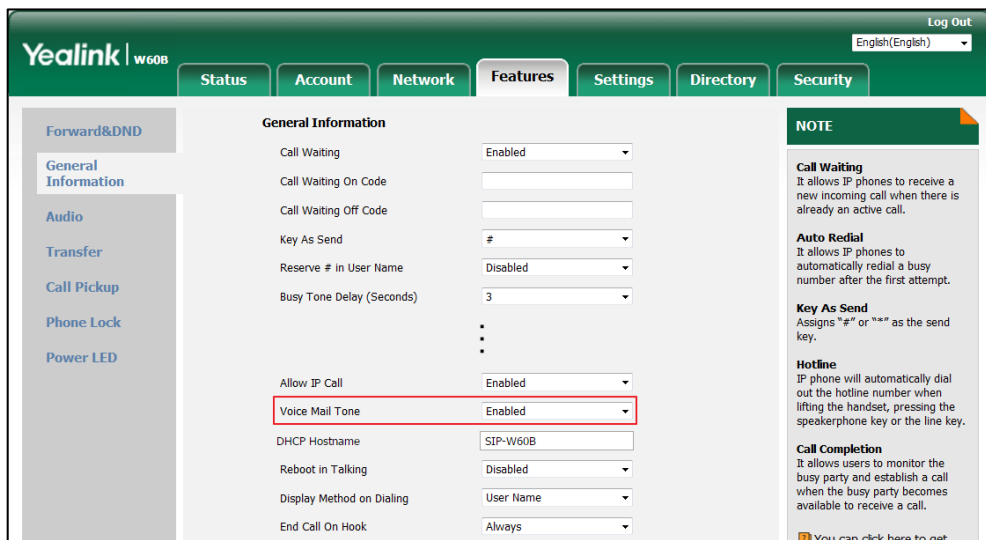

3. Click **Confirm**.

Note Voice mail tone is configurable via web user interface only.

To leave a voice mail:

You can leave a voice mail to someone else when he or she is busy or inconvenient to answer the call. Follow the voice prompts from the system server to leave a voice mail, and then hang up.

To configure voice mail access code via phone user interface:

1. Press **Menu->Message->Voice Mail->Set Voice Mail Code**.

2. Select the account which you want to set.
3. Enter the voice mail access code (for example, *4).
4. Press the **Save** soft key.

Note Voice mail access codes must be predefined on the system server. Contact your system administrator for the more information.

To listen to voice mails:



1. When the phone receives a new voice mail and the power LED indicator slowly flashes red, you can press  or the **Connect** soft key to dial out the voice mail access code.
The phone dials out the voice mail access code using the selected line automatically.
2. Follow the voice prompt to listen to your voice mails.

Note Before listening to voice mails, make sure the voice mail access code has been configured.

Shared Call Appearance (SCA)

You can use Shared Call Appearance (SCA) feature to share an extension, which can be registered on two or more phones at the same time.

The line icons of private line and shared line are different:

Line Icon	Description
	Private line registers successfully.
	Shared line registers successfully and is idle.

If two phones share a line, an incoming call to this extension will cause both phones to ring simultaneously. The incoming call can be answered on either a phone but not both.

This feature is very useful in the boss and secretary scenario. For example, the secretary can share the boss's extension on her phone. When there is an incoming call to the extension of the boss, both the phones of the boss and the secretary will ring simultaneously. Either the boss or the secretary can answer the call. Calls on the shared line can be placed on hold, barged in or retrieved from another shared phone.

Configuring SCA Feature

You can configure a primary account on your phone and other alternate accounts on other phones. For example, party A and party B share the account 4603, party A registers the primary account 4603, party B registers the alternate account 4603_1, and party C registers the account 4605.

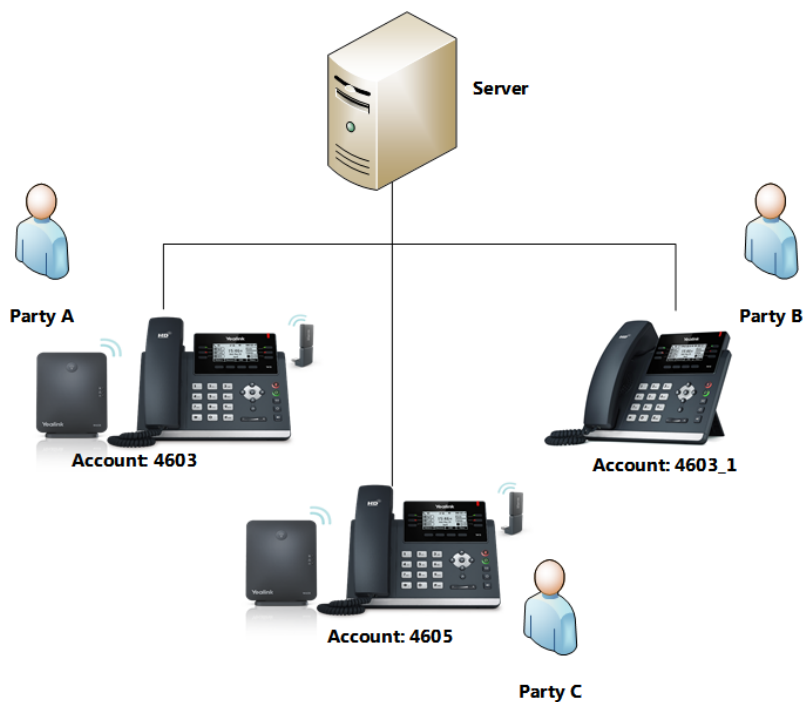

By default, auto linekeys feature is enabled. If you assign a registered line to the phone as the outgoing line, a line key will be automatically assigned with this specific account.

To configure the primary account via web user interface:

1. Register the primary account 4603.

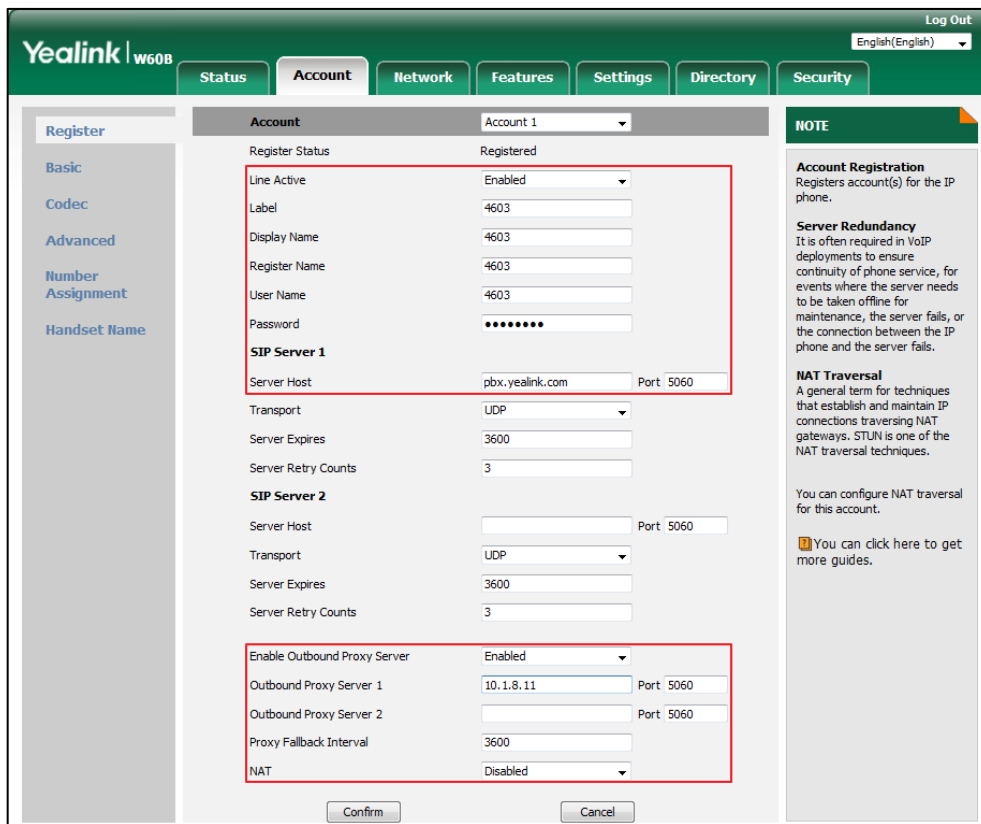

2. Click **Advanced**, select **Share Call Appearance** from the pull-down list of **Shared Line**.

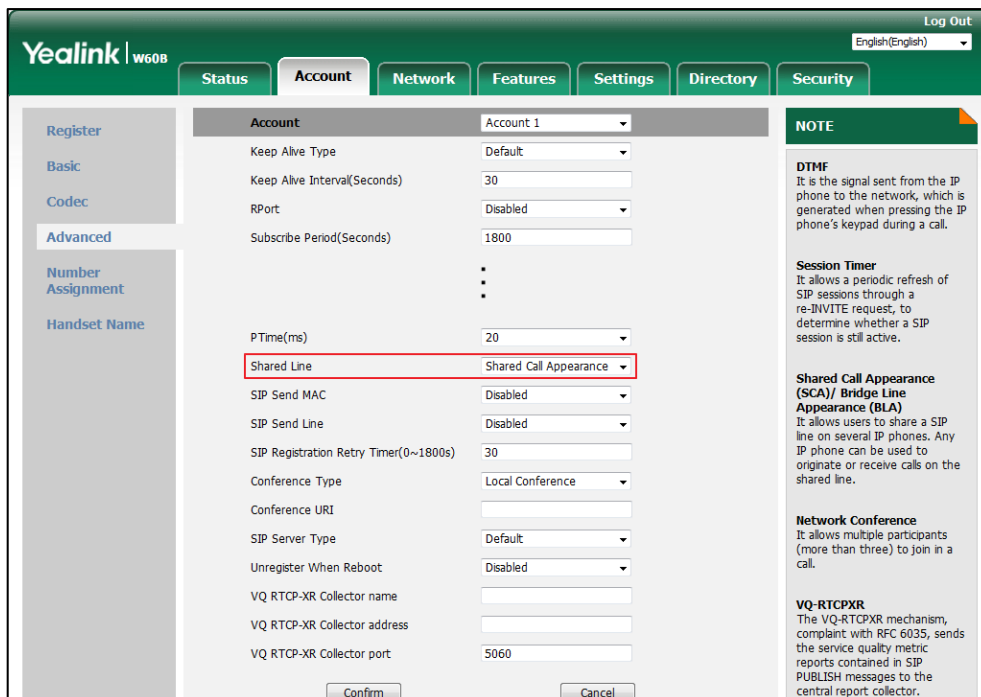

3. Click **Confirm**.

To configure the alternate account via web user interface:

1. Register the alternate account 4603_1.
(Enter the primary account 4603 in the **Register Name** field).
2. Click **Advanced**, select **Share Call Appearance** from the pull-down list of **Shared Line**.
3. Click **Confirm**.

Using SCA Feature on the Phone





You can do the following using SCA feature on the phone:

- Placing calls
- Answering calls
- Placing/Retrieving a call on hold
- Barging in an active call

Placing an SCA Call

To place a call on the shared line:

Do one of following:

- Enter the desired number when the phone is idle. Press , , or the **Send** soft key.
If multiple lines are assigned to your phone as outgoing lines, press the **Line** soft key to select the shared line to dial. If you do not select a line, the phone uses the default outgoing line to dial.
- Press the shared line key when the phone is idle.
Enter the desired number and then press , , or the **Send** soft key.
The phone uses the selected shared line to dial.

Answering Calls

You can have one call or two calls on the shared line.

An incoming call to a shared line causes all phones on the shared line to ring simultaneously. The call can be answered on any of the phones. The LED indicators of shared line keys on all phones will fast flash green.

To answer a call on the shared line:

1. Press the shared line key,  or the **Answer** soft key on the phone.

Placing/Retrieving a Call on Hold

During the SCA call, two types of hold are available: public hold and private hold. When an SCA call is placed on public hold, the held call is available for any shared phone to retrieve. When an SCA call is held privately, the held call can only be retrieved from the shared phone that placed the call on hold.

Using Public Hold

To place an SCA call on public hold:

1. Press the **Hold** soft key.

The line key LEDs on your phone slowly flash green. In addition, the line key LEDs on another phone for the shared line slowly flash red.

The call can be retrieved on either your phone or the other phone on the shared line.

To retrieve a call placed on public hold on your phone:

1. Press the shared line key whose LED indicator slowly flashes green, or the **Resume** soft key.

The conversation between you and the third party is retrieved.

To retrieve a call placed on public hold on another phone on the shared line:

Do one of the following:

- Press the shared line key whose LED indicator slowly flashes red.
- Long press the shared line key.
The **Cancel**, **New Call** and **Retrieve** soft keys appear on the LCD screen.
Press the **Retrieve** soft key to retrieve the call.

The conversation is established between another SCA user and the third party. The line key LEDs on your phone glow red, and that on another phone for the shared line glow green.

Using Private Hold

To place a call on private hold:

1. Press the **More** soft key, and then press the **PriHold** soft key.

To retrieve a call placed on private hold:

The private held call can be only retrieved by the hold party.

Do one of the following:

- Press the shared line key whose LED indicator slowly flashes green.
- Press the **Resume** soft key.

Barging an Active SCA Call

SCA bridging feature allows SCA users to barge in an active call. After a user barges into a call, the call becomes a three-party conference.

To barge in an active SCA call:

If there is an active call on the shared line, do the following:

1. Long press the shared line key.
The **Cancel**, **New Call** and **Barge In** soft keys appear on the LCD screen.
2. Press the **Barge In** soft key to interrupt the active call.

If an SCA user cancels the call, another SCA user is still connected to the remaining party. If the third party cancels the call, the call ends.

Multicast Paging

You can use multicast paging to quickly and easily broadcast time-sensitive announcements to people who are listening to a specific multicast group and a specific channel. You can configure a paging list, which allows you to send a Real Time Transport Protocol (RTP) stream to the pre-configured multicast address(es) and channel(s) without involving SIP signaling. You can configure the phone to receive an RTP stream from pre-configured multicast listening address(es) and channel(s) without involving SIP signaling. You can specify up to 31 multicast listening addresses and channels.

The following describes 31 paging channels:

- **0:** You can broadcast audio to channel 0. Note that the Yealink phones running old firmware version (old paging mechanism) can be regarded as listening to channel 0. It is the default channel.
- **1 to 25:** You can broadcast audio to a specific channel. We recommend that you specify these channels when broadcasting with Polycom IP phones which have 25 channels you can listening to.
- **26 to 30:** You can broadcast audio to a specific channel. We recommend that you specify these channels when broadcasting with Yealink phones running new firmware version (new paging mechanism).

The DD phones will automatically ignore all incoming multicast paging calls on the different channel.

Sending RTP Stream

To configure paging list via web user interface:

1. Click **Directory**-> **Multicast IP**.
2. Enter the multicast IP address(es) and port number (for example, 224.5.6.20:10008) in the **Paging Address** field.
3. Enter the string that will appear on the LCD screen in the **Label** field.

- Select the desired channel from the pull down list of **Channel**.

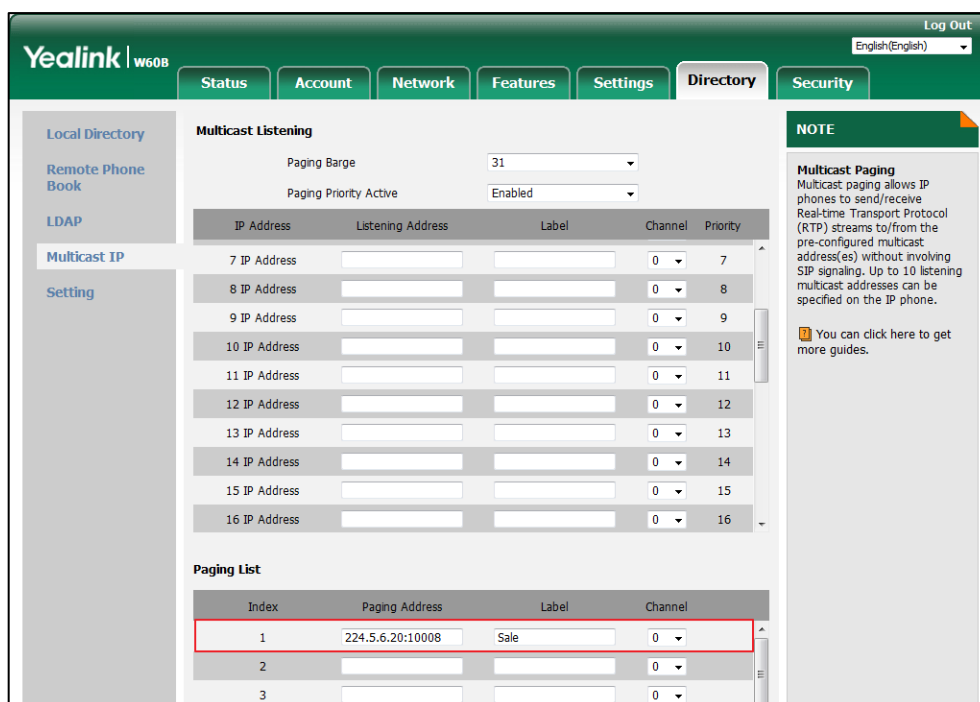

- Click **Confirm**.

To configure a default codec for multicast paging via web user interface:

- Click **Features**->**General Information**.
- Select the desired codec from the pull-down list of **Multicast Codec**.

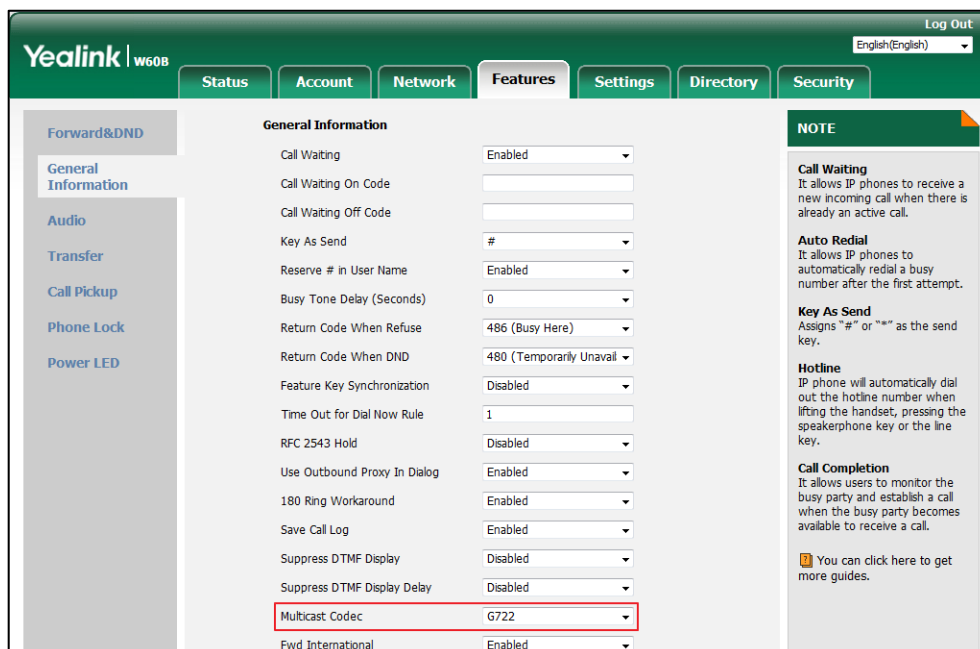

- Click **Confirm**.

Note Default codec for multicast paging is configurable via web user interface only.

Receiving RTP Stream

You can configure the phone to receive a Real Time Transport Protocol (RTP) stream from the pre-configured multicast address(es) and channel(s) without involving SIP signaling. You can specify up to 31 multicast addresses and channels that the phone listens to on the network.

Note

RTP stream is listened in the speakerphone mode by default. If you want to listen the RTP stream using the engaged audio device (speakerphone, handset, or headset), contact your system administrator for more information.

Fixed volume to play RTP stream for specified paging group is configurable by your system administrator.

How the phone handles incoming multicast paging calls depends on Paging Barge and Paging Priority Active parameters are configured via web user interface.

Paging Barge

Paging Barge feature defines the lowest priority of the multicast listening address from which the phone can receive an RTP stream when there is an audio call (not a multicast paging call) in progress. If it is disabled, all incoming multicast paging calls will be automatically ignored. If it is set to a specify priority value, the incoming multicast paging calls with higher or equal priority are automatically answered and the ones with lower priority are ignored. Valid values for Paging Barge:

- **1 to 31:** Define the lowest priority of the multicast listening address from which the phone can receive an RTP stream, 1 with the highest priority, 31 with the lowest.
- **Disabled:** The audio call in progress will take precedence over all incoming paging calls.

Paging Priority Active

Paging Priority Active feature decides how the phone handles incoming multicast paging calls when there is already a multicast paging call on the phone. If enabled, the phone will ignore incoming multicast paging calls with lower priorities, otherwise, the phone will answer incoming multicast paging calls automatically and place the previous multicast paging call on hold. If disabled, the phone will automatically ignore all incoming multicast paging calls.

To configure multicast listening addresses via web user interface:

1. Click **Directory->Multicast IP**.
2. Select the desired value from the pull-down list of **Paging Barge**.
3. Select the desired value from the pull-down list of **Paging Priority Active**.
4. Enter the multicast IP address(es) and port number (for example, 224.5.6.20:10008) which the phone listens to for incoming RTP multicast in the **Listening Address** field.
5. (Optional) Enter the label in the **Label** field.
Label will appear on the LCD screen when receiving the multicast RTP stream.

6. Select the desired channel to listen from the pull-down list of **Channel**.

The screenshot shows the 'Multicast Listening' configuration page in the Yealink W608 web interface. The page has a green header with the Yealink logo and 'w608'. Navigation tabs include Status, Account, Network, Features, Settings, Directory, Security, and Log Out. A sidebar on the left contains links for Local Directory, Remote Phone Book, LDAP, Multicast IP, and Setting. The main content area is titled 'Multicast Listening' and contains a form with the following fields:

- Paging Barge: 31
- Paging Priority Active: Enabled

Below the form is a table with the following columns: IP Address, Listening Address, Label, Channel, and Priority. The first row is highlighted with a red box:

IP Address	Listening Address	Label	Channel	Priority
1 IP Address	224.5.6.20:10008	Sale	0	1
2 IP Address			0	2
3 IP Address			0	3
4 IP Address			0	4
5 IP Address			0	5
6 IP Address			0	6
7 IP Address			0	7
8 IP Address			0	8
9 IP Address			0	9
10 IP Address			0	10

A 'NOTE' box on the right side of the page states: 'Multicast Paging allows IP phones to send/receive Real-time Transport Protocol (RTP) streams to/from the pre-configured multicast address(es) without involving SIP signaling. Up to 10 listening multicast addresses can be specified on the IP phone. You can click here to get more guides.'

7. Click **Confirm**.

Note The priorities of listening addresses are predefined: 1 with the highest priority, 31 with the lowest. Multicast listening addresses are configurable via web user interface only.

Using Multicast Paging

To send RTP stream when the receiver's phone is idle:

1. Press **Menu->Features->Paging List**.
2. Highlight the desired paging group.
3. Press the **Paging** soft key.

The phone sends RTP to a preconfigured multicast address (IP: Port).

Both the sender's and receiver's phones play a warning tone and the receiver automatically answers the multicast RTP session in the speakerphone mode.

You can do the following during paging:

- To place the current multicast RTP session on hold, press the **Hold** soft key.
The sender's phone places the multicast RTP session on hold and receiver's phone releases the session.
To resume the held multicast RTP session, press the **Resume** soft key.
The multicast RTP session is established again.
- To end the multicast RTP session, press the **End Call** soft key.

Troubleshooting

This chapter provides some general troubleshooting information to help you solve the problems you might encounter when using your DD phone.

If you require additional information or assistance with your new phone, contact your system administrator.

Base Issue

Why doesn't the power indicator on the base station light up?

Plug the supplied power adapter to DD phone, if the power indicator doesn't light up, it should be a hardware problem. Please contact your vendor or local distributor for help. If you cannot get a support from them, please send a mail which includes problem description, test result, your country, and phone's SN to Support@yealink.com.



Why does the network indicator on the base station slowly flash?

It means that the base station cannot get an IP address. Try connecting the base to another switch port, if the network indicator still slowly flashes, please try a reset.

Phone Issue

To recognize the area version of phone via phone user interface:

1. Press **Menu->Status->Dongle Status**.

The LCD screen displays information of phone status, you can press  or  to scroll through to the **Area** field.

Register Issue

Why cannot the phone be registered to the base station?

If the network works normally, you can check the compatibility between base station and DD phone. There are two sets of base stations, complied with the FCC and CE standards respectively. You can check it from the back of the base station. There are also two sets of phones: US version and EU version respectively.

The US version phone is compatible with FCC standard base station.

The EU version phone is compatible with CE standard base station.

Call Issue

Why can't the phone receive calls?

- Ensure that the DND mode is not activated. Refer to [Do Not Disturb \(DND\)](#).
- Ensure that Always Forward feature is not enabled. Refer to [Call Forward](#).

Why is there some noise during a call?

- Ensure that you are not using the phone or base station in an area with high electrical interference. You can reposition the phone and the base station to keep them far away from the sources of high electrical interference.
- Ensure that the phone is not too far from the base station.
- Restart the base station and place a call to see if there is still noise during the call.

Paging Issue

Why does paging fail?

- Check the current mode of the base station. If the base station is not in the paging mode, press the paging key on the base station to enter the paging mode.
- Ensure that there is at least one DD phone registered to the base station.

Audio Issue

Why doesn't the phone ring?

Ensure that the ringer volume of your phone is not adjusted to the minimum. Refer to [Adjusting Volume](#).

Why can you hear the verification tone from phone if the call is successfully handled by the RT10?

To deactivate the verification tone on the RT10:

1. Switch off the repeater (disconnect the power adapter).
2. Switch it on for 1 to 5 seconds and switch it off again.
3. Switch it on again. The LED indicator on the repeater flashes slowly.
4. Switch it off again.
5. Switch it on again.

The verification tone is then deactivated. If you want to activate the verification tone, repeat the above steps.

Display Issue

Why does the phone prompt the message “Unregistered!”?

Check the registration status of your DD phone. If your phone is not registered to the base station, register it manually. Refer to [Phone Registration](#).

Why does the phone prompt the message “Not In Range”?

- Ensure that the base station is properly plugged into a functional AC outlet.
- Ensure that the DD phone is not too far from the base station.

Why does the phone prompt the message “Network unavailable!”?

- Ensure that the Ethernet cable is plugged into the Internet port on the base station and the Ethernet cable is not loose.
- Ensure that the switch or hub in your network is operational.

Update & Reset Issue

How to upgrade base station firmware?

To upgrade base station firmware via web user interface:

1. Click **Settings->Upgrade**.
2. In the **Select And Upgrade Firmware** field, click **Browse** to locate the firmware file from your local system.
3. Click **Upgrade** to upgrade the base station firmware.
4. Click **OK** to upgrade.
The upgrading will take a few minutes.

Note

Do not refresh or close the browser, or power off during the base station upgrading.

How to upgrade phone firmware?

To upgrade phone firmware via web user interface:

1. Click **Settings->Upgrade**.
2. In the **Select and Upgrade Handset Firmware** field, click **Browse** to locate the firmware file from your local system.
3. Click **Upgrade** to upgrade the phone firmware.
4. Click **OK** to upgrade.

The upgrading will take a few minutes.

Note Do not refresh or close the browser, or power off during the phone upgrading.

How to upgrade dongle firmware?

You can easily upgrade dongle firmware after the phone has been upgraded to the latest firmware.

To upgrade dongle firmware via phone user interface:

1. Assemble the DD10K.
2. If the phone is in the SIP mode, reboot the phone.
The LCD screen prompts whether to upgrade the dongle to a new available firmware version.
3. Press the **OK** soft key.

Note Do not power off the phone or detach the dongle during the dongle upgrading.

You can check the firmware version of the base station/phone/dongle via phone user interface. For more information, refer to [Checking System Status](#).

How to restore the base PIN?

1. Disconnect the power adapter.
2. Long press the paging key and reconnect the power adapter.
After resetting base station, the power LED indicator, network status LED, and registration LED will glow in sequence. Base PIN and all individual settings are reset to factory defaults. Phone registrations will also be cleared after base station reset.

Log Issue

How to export PCAP trace?

We may need you to provide a PCAP trace to help analyze your problem.

To export a PCAP trace via web user interface:

1. Click **Settings->Configuration**.
2. In the **Pcap Feature** field, click **Start** to begin capturing signal traffic.

3. Recreate the error to be documented in the trace.

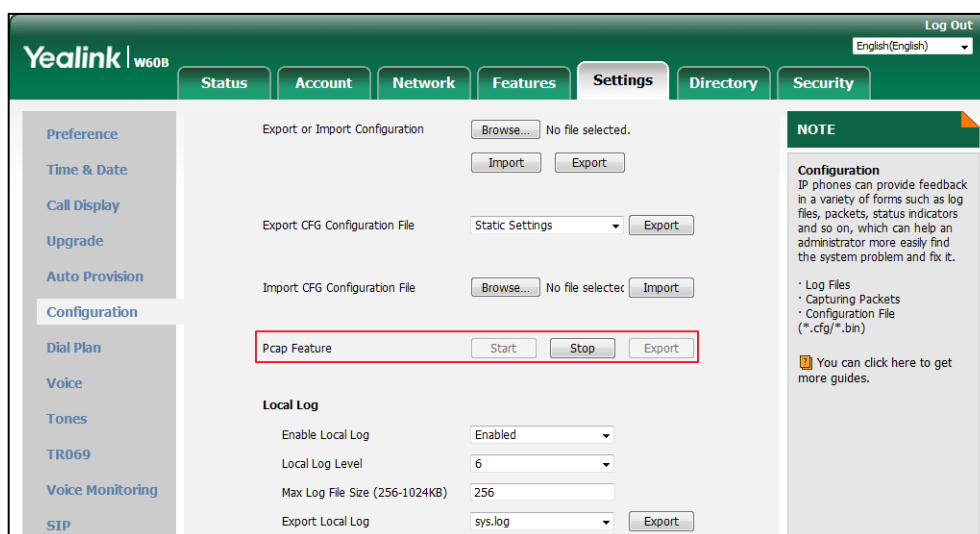

4. Click **Stop** to stop the capture.
5. Click **Export** to open file download window, and then save the file to your local system.

How to export system log?

We may need you to provide a system log or boot log to help analyze your problem.

To export the system log to a local PC via web user interface:

1. Click **Settings**->**Configuration**.
2. Select **Enabled** from the pull-down list of **Enable Local Log**.
3. Select **6** from the pull-down list of **Local Log Level**.

The default local log level is "3".

4. Select **sys.log** from the pull-down list of **Export Local Log**.

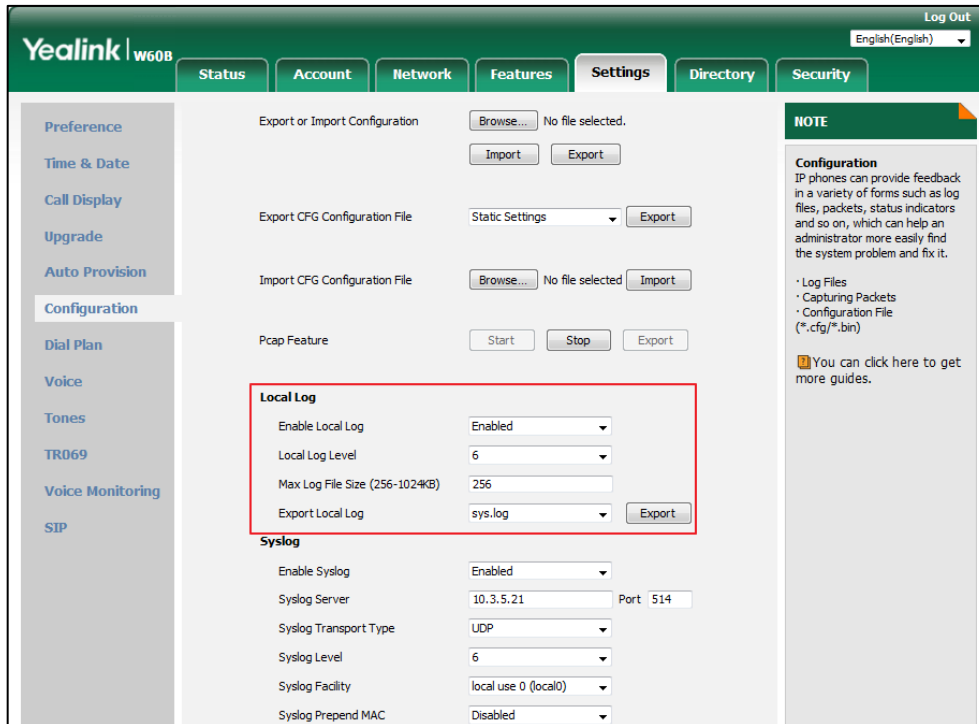

5. Click **Confirm**.
6. Reproduce the issue.
7. Click **Export** to open the file download window, and then save the file to your local system.

You can also export the system log to a syslog server. Contact your system administrator for more information.

Note It is recommended to reset the local log level to 3 after exporting the system log.

To export the boot log to a local PC via web user interface:

1. Click **Settings->Configuration**.
2. Select **Enabled** from the pull-down list of **Enable Local Logging**.
3. Select **boot.log** from the pull-down list of **Export Local Log**.
4. Click **Confirm**.
5. Click **Export** to open the file download window, and then save the file to your local system.

How to export all diagnostic files?

We may need you to provide three types of diagnostic files (including PCAP trace, system log, and BIN configuration file) to help analyze your problem. You can export these files at a time.

To export all diagnostic files via web user interface:

1. Click **Settings->Configuration**.

2. Click **Start** to begin capturing signal traffic.
The system log level will be automatically set to 6.
3. Reproduce the issue.
4. Click **Stop** to stop the capture.
The system log level will be reset to 3.
5. Click **Export** to open file download window, and then save diagnostic files to your local system.

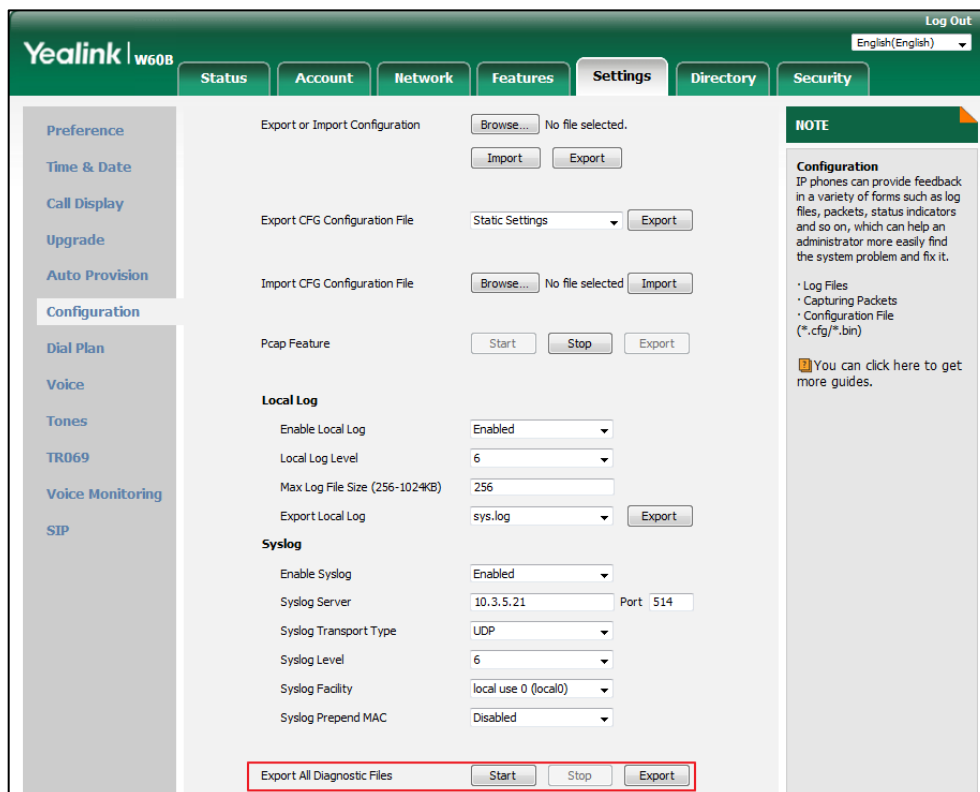

A diagnostic file named **allconfig.tgz** is successfully exported to your local system.

Note If the issue cannot be reproduced, just directly click **Export** to export all diagnostic files.

Appendix

Appendix A - Time Zones

Time Zone	Time Zone Name
-11	Samoa
-10	United States-Hawaii-Aleutian, United States-Alaska-Aleutian
-9:30	French Polynesia
-9	United States-Alaska Time
-8	Canada(Vancouver,Whitehorse), Mexico(Tijuana,Mexicali), United States-Pacific Time
-7	Canada(Edmonton,Calgary), Mexico(Mazatlan,Chihuahua), United States-MST no DST, United States-Mountain Time
-6	Canada-Manitoba(Winnipeg), Chile(Easter Islands), Mexico(Mexico City,Acapulco), United States-Central Time
-5	Bahamas(Nassau), Canada(Montreal,Ottawa,Quebec), Cuba(Havana), United States-Eastern Time
-4:30	Venezuela(Caracas)
-4	Canada(Halifax,Saint John), Chile(Santiago), Paraguay(Asuncion), United Kingdom-Bermuda(Bermuda), United Kingdom(Falkland Islands), Trinidad&Tobago
-3:30	Canada-New Foundland(St.Johns)
-3	Argentina(Buenos Aires), Brazil(DST), Brazil(no DST), Denmark-Greenland(Nuuk)
-2:30	Newfoundland and Labrador
-2	Brazil(no DST)
-1	Portugal(Azores)
0	Denmark-Faroe Islands(Torshavn), GMT, Greenland, Ireland(Dublin), Morocco, Portugal(Lisboa,Porto,Funchal), Spain-Canary Islands(Las Palmas), United Kingdom(London)
+1	Albania(Tirane), Austria(Vienna), Belgium(Brussels), Caicos, Chad, Croatia(Zagreb), Czech Republic(Prague), Denmark(Kopenhagen), France(Paris), Germany(Berlin), Hungary(Budapest), Italy(Rome), Luxembourg(Luxembourg), Macedonia(Skopje), Namibia(Windhoek), Netherlands(Amsterdam), Spain(Madrid)
+2	Estonia(Tallinn), Finland(Helsinki), Gaza Strip(Gaza), Greece(Athens), Israel(Tel Aviv), Jordan(Amman), Latvia(Riga), Lebanon(Beirut), Moldova(Kishinev), Romania(Bucharest), Russia(Kaliningrad), Syria(Damascus), Turkey(Ankara), Ukraine(Kyiv, Odessa)
+3	East Africa Time, Iraq(Baghdad), Russia(Moscow)
+3:30	Iran(Teheran)
+4	Armenia(Yerevan), Azerbaijan(Baku), Georgia(Tbilisi), Kazakhstan(Aktau), Russia(Samara)
+4:30	Afghanistan(Kabul)
+5	Kazakhstan(Aqtobe), Kyrgyzstan(Bishkek), Pakistan(Islamabad), Russia(Chelyabinsk)
+5:30	India(Calcutta)
+5:45	Nepal(Katmandu)
+6	Kazakhstan(Astana, Almaty), Russia(Novosibirsk,Omsk)
+6:30	Myanmar(Naypyitaw)
+7	Russia(Krasnoyarsk), Thailand(Bangkok)
+8	Australia(Perth), China(Beijing), Russia(Irkutsk, Ulan-Ude), Singapore(Singapore)
+8:45	Eucla

Time Zone	Time Zone Name
+9	Japan(Tokyo), Korea(Seoul), Russia(Yakutsk,Chita)
+9:30	Australia(Adelaide), Australia(Darwin)
+10	Australia(Brisbane), Australia(Hobart), Australia(Sydney,Melbourne,Canberra), Russia(Vladivostok)
+10:30	Australia(Lord Howe Islands)
+11	New Caledonia(Noumea), Russia(Srednekolymsk Time)
+11:30	Norfolk Island
+12	New Zealand(Wellington,Auckland), Russia(Kamchatka Time)
+12:45	New Zealand(Chatham Islands)
+13	Tonga(Nukualofa)
+13:30	Chatham Islands
+14	Kiribati

Appendix B - Menu Structure

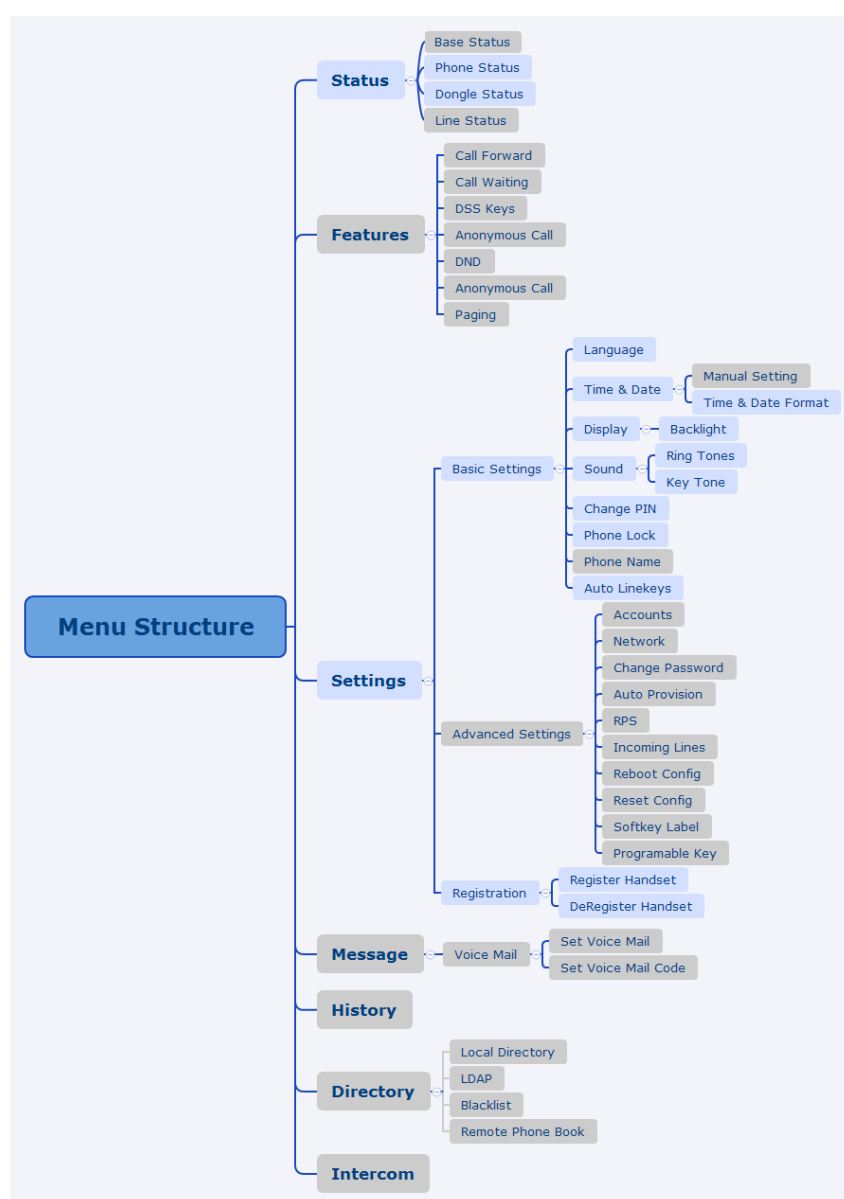

Note The menus with gray box are not available when the phone does not register to a base station.