



Video Conferencing System VC400 User Guide

Copyright

Copyright © 2015 YEALINK NETWORK TECHNOLOGY CO., LTD.

Copyright © 2015 Yealink Network Technology CO., LTD. All rights reserved. No parts of this publication may be reproduced or transmitted in any form or by any means, electronic or mechanical, photocopying, recording, or otherwise, for any purpose, without the express written permission of Yealink Network Technology CO., LTD. Under the law, reproducing includes translating into another language or format.

When this publication is made available via the media, Yealink Network Technology CO., LTD. gives its consent to downloading and printing copies of the content provided in this file only for private use only and not for redistribution. No parts of this publication may be subject to alteration, modification or commercial use. Yealink Network Technology CO., LTD. will not be liable for any damages arising from use of an illegally modified or altered publication.

Warranty

THE SPECIFICATIONS AND INFORMATION REGARDING THE PRODUCTS IN THIS GUIDE ARE SUBJECT TO CHANGE WITHOUT NOTICE. ALL STATEMENTS, INFORMATION, AND RECOMMENDATIONS IN THIS GUIDE ARE BELIEVED TO BE ACCURATE AND PRESENTED WITHOUT WARRANTY OF ANY KIND, EXPRESS OR IMPLIED. USERS MUST TAKE FULL RESPONSIBILITY FOR THEIR USE OF PRODUCTS.

YEALINK NETWORK TECHNOLOGY CO., LTD. MAKES NO WARRANTY OF ANY KIND WITH REGARD TO THIS GUIDE, INCLUDING, BUT NOT LIMITED TO, THE IMPLIED WARRANTIES OF MERCHANTABILITY AND FITNESS FOR A PARTICULAR PURPOSE. Yealink Network Technology CO., LTD. shall not be liable for errors contained herein nor for incidental or consequential damages in connection with the furnishing, performance, or use of this guide.

Declaration of Conformity



Hereby, Yealink Network Technology CO., LTD. declares that this phone is in conformity with the essential requirements and other relevant provisions of the CE, FCC.

CE Mark Warning

This device is marked with the CE mark in compliance with EC Directives 2006/95/EC and 2004/108/EC.

Part 15 FCC Rules

This device is compliant with Part 15 of the FCC Rules. Operation is subject to the following two conditions:

1. This device may not cause harmful interference.
2. This device must accept any interference received, including interference that may cause undesired operation.

Class B Digital Device or Peripheral

Note: This device is tested and complies with the limits for a Class B digital device, pursuant to Part 15 of the FCC Rules. These limits are designed to provide reasonable protection against harmful interference in a residential installation. This equipment generates, uses, and can radiate radio frequency energy and, if not installed and used in accordance with the instructions, may cause harmful interference to radio communications. However, there is no guarantee that interference will not occur in a particular installation. If this equipment does cause harmful interference to radio or television reception, which can be determined by turning the equipment off and on, the user is encouraged to try to correct the interference by one or more of the following measures:

1. Reorient or relocate the receiving antenna.
2. Increase the separation between the equipment and receiver.
3. Connect the equipment into an outlet on a circuit different from that to which the receiver is connected.
4. Consult the dealer or an experienced radio/TV technician for help.

WEEE Warning



To avoid potential effects on the environment and human health as a result of the presence of hazardous substances in electrical and electronic equipment, end users of electrical and electronic equipment should understand the meaning of the crossed-out wheeled bin symbol. WEEE must not be regarded as unsorted municipal waste and must be collected and disposed of separately by a competent authority.

Customer Feedback

We are striving to improve our documentation quality and we appreciate your feedback. Email your opinions and comments to DocsFeedback@yealink.com.

GNU GPL INFORMATION

Yealink VC400 video conferencing system firmware contains third-party software under the GNU General Public License (GPL). Yealink uses software under the specific terms of the GPL. Please refer to the GPL for the exact terms and conditions of the license.

The original GPL license, source code of components licensed under GPL and used in Yealink products can be downloaded online:

<http://www.yealink.com/GPLOpenSource.aspx?BaseInfoCatId=293&NewsCatId=293&CatId=293>.

About This Guide

Thank you for choosing the Yealink VC400 full HD video conferencing system. It supports 1080P full-HD video conferencing and includes outstanding features such as good compatibility, easy deployment and intelligent network adaptability. This makes it the perfect choice for SMEs.

The Yealink VC400 full-HD video conferencing system is designed to help enterprises organize video conferences easily and efficiently. Users can expect to enjoy the high-quality video conferencing experience very cost-effectively.

This guide provides everything you need to start using your new video conferencing system. First, verify with your system administrator that the IP network is ready for system configuration. Also be sure to read the **Overview** and **Getting Started** sections in this guide before you set up and use the VC400 video conferencing system.

In This Guide

Topics provided in this guide include:

- Chapter 1 [Overview](#)
- Chapter 2 [Getting Started](#)
- Chapter 3 [Customizing the VC400 Video Conferencing System](#)
- Chapter 4 [Using the VC400 Video Conferencing System](#)
- Chapter 5 [Troubleshooting](#)

Table of Contents

About This Guide	v
In This Guide.....	v
Table of Contents.....	vii
Overview	1
Packaging Contents.....	1
Optional Accessory	3
System Component Instructions.....	4
VC400 Codec	4
VCC18 HD Camera.....	5
VCP40 Video Conferencing Phone.....	6
VCR10 Remote Control.....	9
Icon Instructions.....	11
Icons on Display Device	11
Icons on VCP40 Video Conferencing Phone	12
LED Instructions	13
User Interfaces.....	14
Remote Control	14
Web User Interface.....	15
Documents.....	16
Getting Started.....	17
System Installation.....	17
Installing the VC400 Video Conferencing System.....	18
Installing the Camera	19
Installing Batteries for the Remote Control.....	20
Connecting the CPE80 Expansion Microphone.....	21
Powering the System On or Off.....	21
Setup Wizard.....	22
Registration	25
Idle Screen Display.....	26
Navigating Menus on the Display Device.....	27
Entering Data and Editing Fields	28
System Status.....	29
Customizing the VC400 Video Conferencing System	33
General Settings	33
Automatic Sleep Time.....	33
Backlight.....	34
Site Name.....	35
Language	36
Time & Date.....	37
Key Tone	39
Audio Settings.....	40
Local Directory	42
Call History Management.....	54

Call Type.....	59
Bandwidth Settings.....	60
Audio Setting.....	61
Audio Output Device	61
Audio Input Device	62
Far-end Camera Control	63
Using the VC400 Video Conferencing System.....	65
Placing Calls.....	65
Placing a Call Using the Remote Control.....	66
Placing a Call Using the VCP40 Phone	67
Placing a Call via the Web User Interface	67
Placing Multiple Calls	67
Answering or Rejecting Calls.....	69
Auto Answer.....	69
Do Not Disturb (DND)	70
Ending Calls	72
Call Management.....	74
Call Mute.....	74
Call Statistics.....	74
Presentation	75
Changing the Video Layout.....	76
Controlling the Camera.....	79
Changing the Video Input Source.....	81
Video Recording.....	82
Screenshot.....	84
Troubleshooting	87
System Diagnostics.....	87
General Issues	88
Camera Issues	89
Display Issues.....	90
Video & Audio Issues	90
System Maintenance.....	91
Regulatory Notices	97
Service Agreements	97
Limitations of Liability.....	97
Safety Instructions.....	97
Restriction of Hazardous Substances.....	99
Appendix A - Time Zones.....	101
Index.....	105

Overview

This chapter provides an overview of the VC400 video conferencing system. Topics include:

- [Packaging Contents](#)
- [System Component Instructions](#)
- [Icon Instructions](#)
- [LED Instructions](#)
- [User Interfaces](#)
- [Documents](#)

If you require additional information, or assistance to help you use your new system, contact your system administrator.

Packaging Contents

The following items are included in your package. If you find that anything is missing, contact your system administrator.

- **VC400 Codec**



- **VCC18 HD Camera**

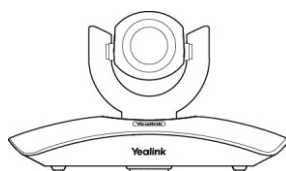

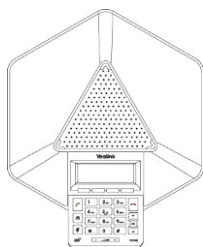

- **VCP40 Video Conferencing Phone**

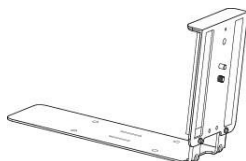

- **L-Bracket (for installing the camera)**



- **Camera Mounting Accessories**

- Expansion bolts  × 4
- Screws(Specificaiton: T4×30)  × 4
- Screws(Specificaiton: M3×8)  × 2

- **VCR10 Remote Control**



- **2 AAA Batteries**



- **Power Adapter**

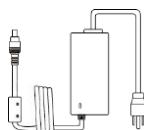

- **Cables**

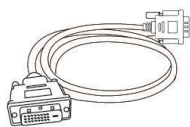

DVI Cable

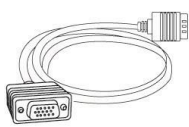

VGA Cable



HDMI Cables X 2



3.5mm Audio Cable

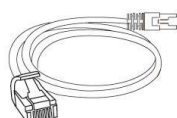

Ethernet Cable
(2m)

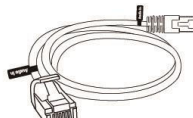

Ethernet Cable
(7.5m)

- **7 Cable Ties**



- **Quick Start Guide**



Check the list before installation. If you find that anything is missing, contact your system administrator.

Optional Accessory

The following item is optional. You should purchase it separately if necessary.

The CPE80 expansion microphone is used for expanding the audio pickup range.

- **CPE80 Expansion Microphone**

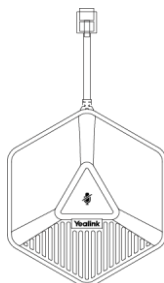

System Component Instructions

Before installing and using the VC400 video conferencing system, you need to be familiar with the following system components:

VC400 Codec

VC400 codec compresses outgoing video and audio data, transmits this information to the far end, and decompresses incoming data. It supports 16:9 and 4:3 aspect ratios. It can be compatible with different audio output devices, and can adapt to the display devices automatically.

You do not need to change the VC400 codec once it has been installed properly in your environment.

VC400 codec front panel

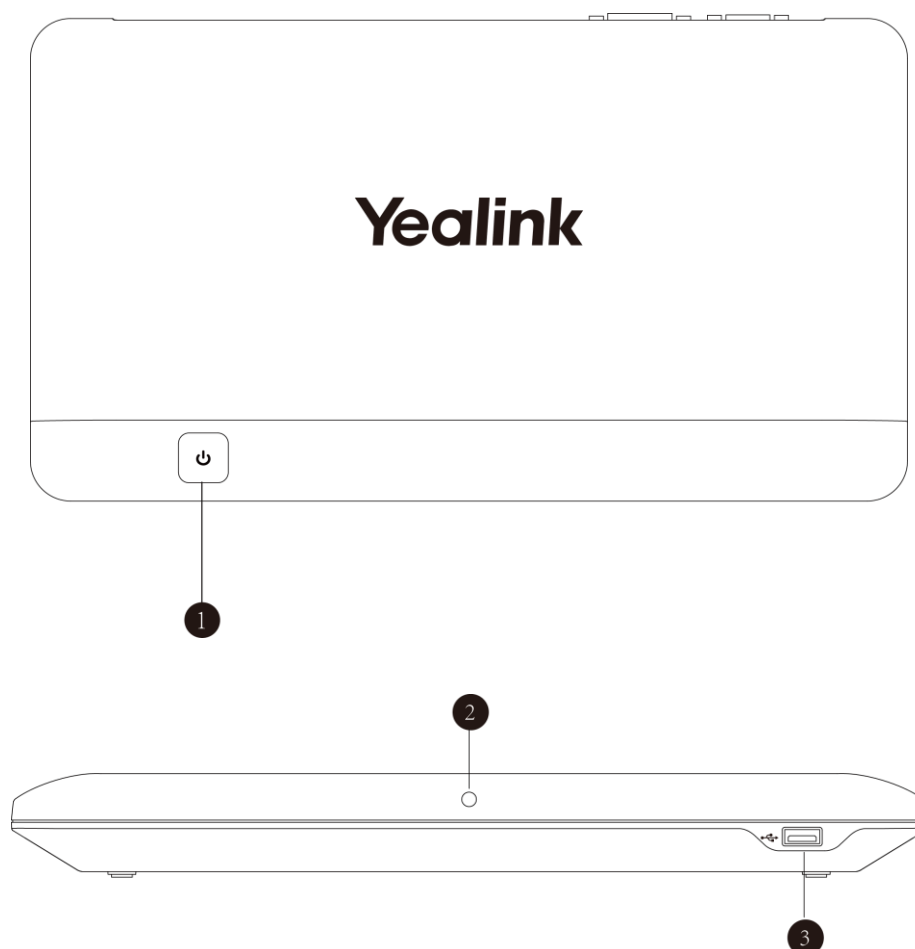

VC400 codec back panel

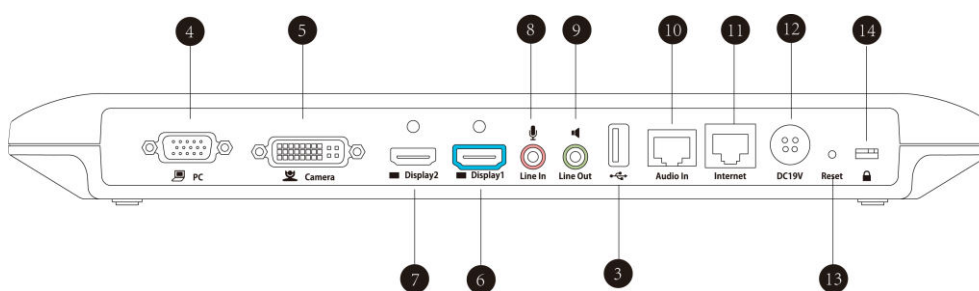

	Port Name	Description
①	Power Button	Powers the system on or off
②	LED Indicator	Indicates different system statuses
③	USB	Inserts a USB flash drive to the port for storing screenshots and recording videos
④	PC	Connects to a PC for sharing documents or videos during a conference call
⑤	Camera	Connects to a camera
⑥	Display1	Connects to a display device for displaying video images When connecting only one display device to the VC400 codec, Display1 port is the only available port.
⑦	Display2	Connects to another display device for displaying video images
⑧	Line In	Connects to an audio input device using the supplied audio cable
⑨	Line Out	Connects to an audio output device using the supplied audio cable
⑩	Audio In	Connects to the VCP40 video conferencing phone
⑪	Internet	Connects to the network devices
⑫	DC19V	Connects to the power adapter
⑬	Reset Key	Resets the system to factory defaults
⑭	Security Slot	Allows you to connect a universal security cable to VC400 codec, so you can lock it down. The system cannot be removed when locked.

VCC18 HD Camera

The VCC18 HD camera supports 18x optical zoom, white balance and automatic gain. You can place the camera on the table or mount it on a wall. The LED indicator in front of

the camera indicates different statuses of the system. For more information, refer to [LED Instructions](#) on page 13.

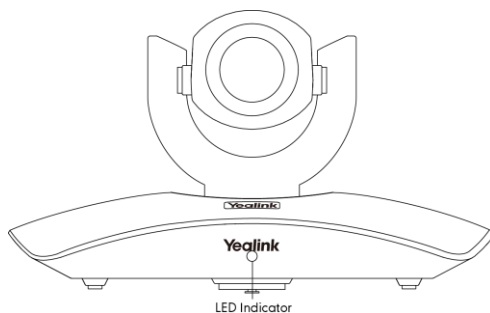

You can use the remote control to adjust the position or focus of the camera. The VCC18 camera can be panned (± 100 degrees range), tilted (± 30 degrees range).

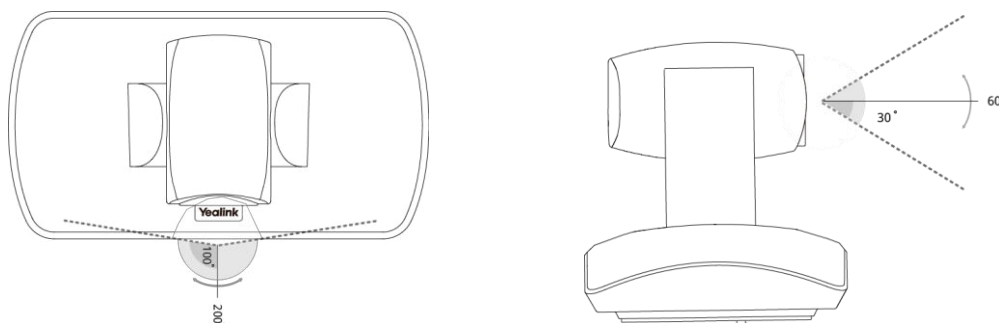

Infrared Sensor

The infrared sensor is located within the Yealink logo. Aim the remote control at the camera IR sensor to operate the unit.

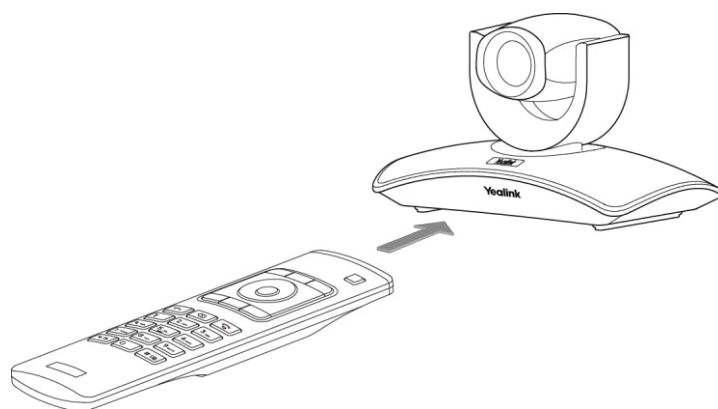



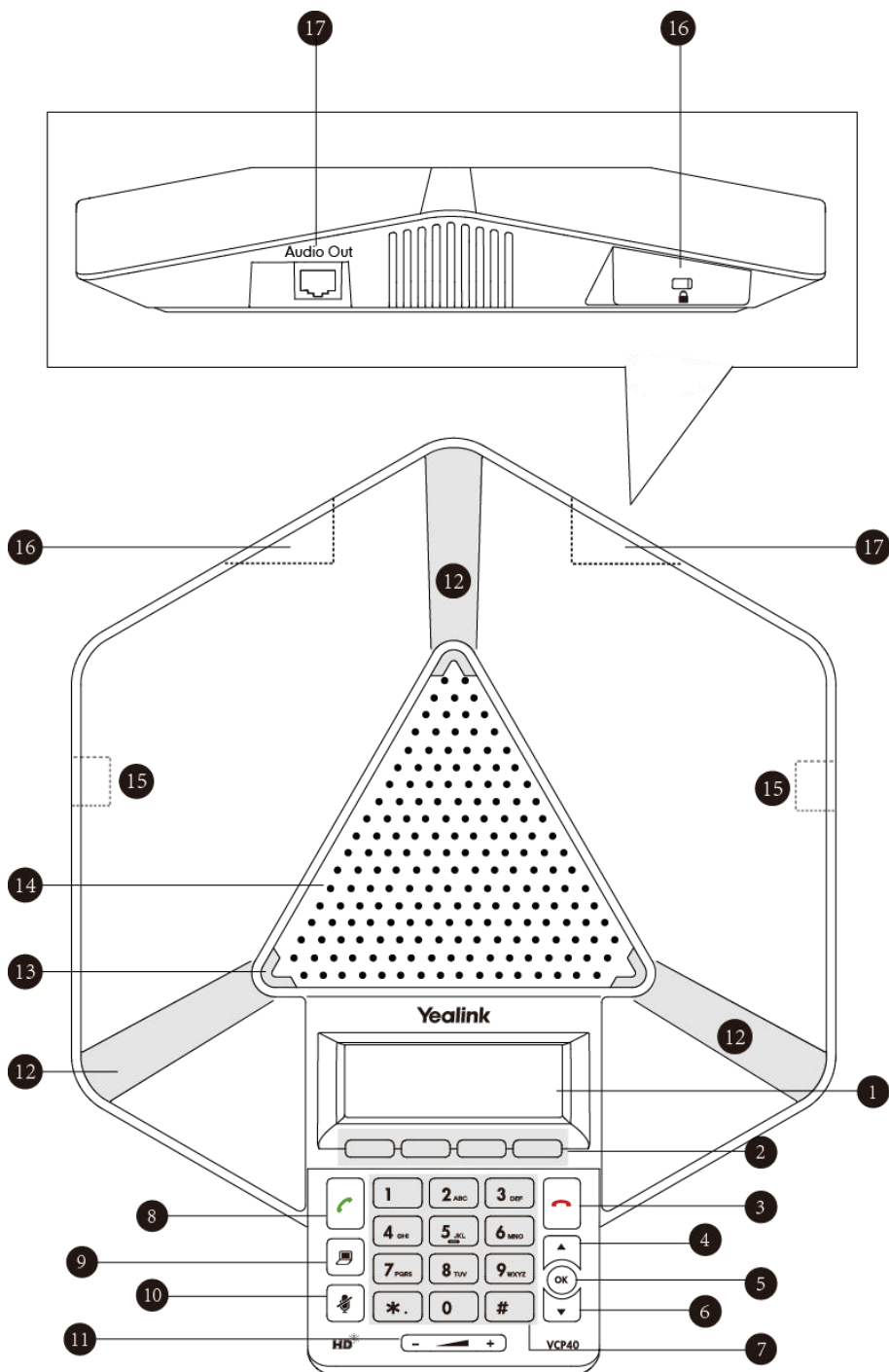

VCP40 Video Conferencing Phone

The VCP40 video conferencing phone supports 360-degree audio pickup to achieve ultra-HD voice.

Connect the VCP40 phone to the VC400 codec. It can work as an audio device for the system. You can also place calls, answer calls or view directory and history on the VCP40 phone.



System component instructions of the VCP40 phone are:

	Item	Description
①	LCD Screen	Shows information about calls, messages, soft keys, time, date and other relevant data: <ul style="list-style-type: none"> • Call information—call duration • Icons (for example, ) • Missed call information • Time and date
②	Soft Keys	Label automatically to identify their context-sensitive features.
③	On-hook Key	Rejects or ends a call or returns to the previous screen.
④		Scrolls upwards through the displayed information.
⑤		Enters list or answers incoming calls.
⑥		Scrolls downwards through the displayed information.
⑦	Keypad	Provides the digits and symbol characters “. ” “#”.
⑧	Off-hook Key	Initiates a call or answers a call.
⑨	Presentation Key	Enables or disables presentation.
⑩	Mute Key	Toggles the mute feature.
⑪	Volume Key	Adjusts the volume of the speakerphone and ringer.
⑫	Microphone	Picks up voice.
⑬	LED Indicators	Indicate phone and call statuses.
⑭	Speakerphone	Provides ringer and hands-free (speakerphone) audio output.
⑮	MIC Port	Connects to a CPE80 expansion microphone.
⑯	Security Slot	Allows you to connect a universal security cable to lock down your phone. The phone cannot be removed when locked.
⑰	Audio Out Port	Connects to the VCP40 phone using the Ethernet cable labeled Audio in. Provides the power supply for the VCP40 phone.

VCR10 Remote Control

The VCR10 remote control provides 3 shortcut keys. It can help users to organize conference easily with intuitive and efficient operation in all screens.

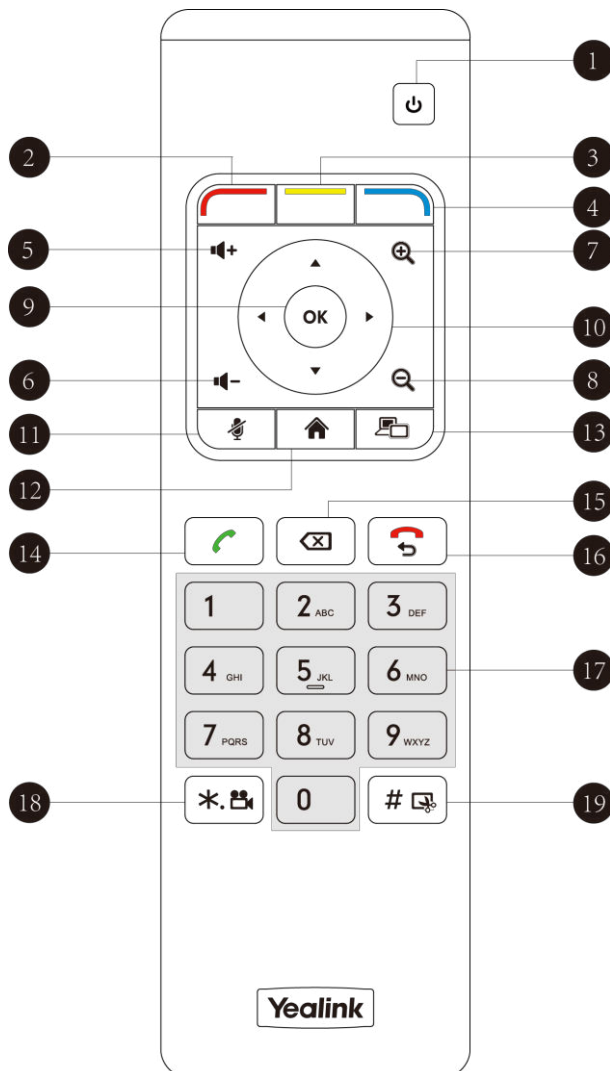

Hardware components of the remote control:

	Item	Description
①	Sleep Key	Puts the system to sleep or wakes the system up.
②	Red Shortcut Key	Located at the bottom left of the screen. Label automatically identifies context-sensitive features. In the idle screen, this is used to enter main menu screen, corresponds to the Menu soft key.
③	Yellow Shortcut Key	Located at the bottom of the screen. Label automatically identifies context-sensitive features. In the idle screen, this is used to enter the pre-dialing screen, and corresponds to the Call soft key.















	Item	Description
④	Blue Shortcut Key	Located at the bottom right of the screen. Label automatically identifies context-sensitive features. In the idle screen, this is used to save and check the camera preset position, and corresponds to the Preset soft key.
⑤	Vol+	Increases the system volume.
⑥	Vol-	Decreases the system volume.
⑦	Zoom out Key	Zooms the camera out.
⑧	Zoom in Key	Zooms the camera in.
⑨	OK Key	Confirms actions or answers incoming calls.
⑩	Navigation Key	<ul style="list-style-type: none"> In the menu screen, press ◀ or ▶ to switch menus, press ▲ or ▼ to select items. In the idle screen, pan and tilt the camera to adjust the viewing angle.
⑪	Mute Key	Toggles the mute feature.
⑫	Home Key	<ul style="list-style-type: none"> Returns to the idle screen when in the menu screen. Enters the pre-dialing screen during a call.
⑬	Video Source Key	Selects video input sources.
⑭	Off-hook Key	<ul style="list-style-type: none"> Enters the pre-dialing screen. Places a call. Answers a call.
⑮	Delete key	Deletes the entered characters.
⑯	On-hook Key	<ul style="list-style-type: none"> Ends a call or exits from a conference call. Returns to the previous screen when not in a call.
⑰	Keypad	<ul style="list-style-type: none"> Enters digits. Enters the pre-dialing screen. Stores the preset position of the camera.
⑱	Video Recording Key	<ul style="list-style-type: none"> Provides the special characters "*" or ".". Starts/Stops recording video when the phone is idle.
⑲	Snapshot Key	<ul style="list-style-type: none"> Provides the pound key (#).















	Item	Description
		<ul style="list-style-type: none"> • Captures the on-screen image of the display device when the phone is idle.

Icon Instructions

Icons on Display Device



Icons appearing on the display device are described in the following table:













Icon	Description
 (flashing)	Network is disconnected
	Network is available
	Packet loss
 (flashing)	VCP40 video conferencing phone is not connected
 (flashing)	Camera is not connected
	SIP account is registered
	H.323 account is registered
	Lowercase letters input mode of the on-screen keyboard
	Uppercase letters input mode of the on-screen keyboard
	Symbol input mode of the on-screen keyboard
	Auto answer
	Missed calls
	Volume is 0
	Do not disturb
	Do not disturb during a call

Icon	Description
	Call mute
	Call encryption
	The content of the local camera
	Focus content
	Camera position
	Record a video
	Dialed calls
	Received calls
	Missed calls
	Dual screen mode
	Dual video sources (when a PC is connected to the PC port on the VC400 codec)
	A USB flash drive is inserted to the USB port on the VC400 codec
	Local contact
	Conference contact
	VPN is enabled

Icons on VCP40 Video Conferencing Phone

Icons appearing on the VCP40 LCD screen are described in the following table:

Icon	Description
 (Flashing)	Network is unavailable
	SIP account is registered (the icon flashes when the SIP account is not registered successfully)

Icon	Description
	H.323 account is registered (the icon flashes when the H.323 account is not registered successfully)
	Auto answer
	Do not disturb
	Call is muted
	Volume is 0
	A USB flash drive is inserted in the port on the VC400 codec
	Record a video
	Local contact
	Conference contact
	Conference call
	Received calls
	Dialed calls
	Missed calls

LED Instructions

Indicator LED on the codec:

LED Status	Description
Solid green	The VC400 codec is powered on.
Flashing red	The VC400 codec is upgrading firmware.
Solid red	The VC400 codec is in sleep mode.
Solid orange	System exception (e.g., network unavailable, update failure).
Off	The VC400 codec is powered off, or is not connect to the power adapter.

Indicator LED on the camera:

LED Status	Description
Solid green	The camera is properly connected to the codec, and the VC400 codec is powered on.
Solid red	The VC400 codec is in sleep mode.
Flashing green	Press the key on the remote control.
Off	The camera is not connected properly to the VC400 codec, or the VC400 codec is powered off.

Indicator LED on the VCP40:

LED Status	Description
Solid red	The phone is initializing. The call is muted.
Flashing red	The phone is ringing.
Solid green	The phone is placing a call. There is an active call on the phone.
Off	The phone is idle.

User Interfaces

There are two ways to customize the configurations of your VC400 video conferencing system:

- Remote control
- The user interface in a web browser on your PC.

Note

The display device and remote control constitute the system user interface. This allows the user to execute all call operation tasks and basic configuration changes directly. Detailed operational steps will be explained in the feature section.

Remote Control

You can use the remote control and display device to configure and use the VC400 video conferencing system.



For more information about the function of each key on the remote control, refer to [VCR10 Remote Control](#) on page 9.

The Advanced option is only accessible to the administrator. The default administrator password is "0000". For more information about how to view, enter and edit the menu settings on the display device, refer to [Navigating Menus on the Display Device](#) on page 27 and [Entering Data and Editing Fields](#) on page 28.

Web User Interface

You can customize your system via the web user interface. To access the web user interface, you need to know the IP address of your new system.

To obtain the IP address, do one of the following:

- The IP address of the system is shown on the top right corner of the display device.
- Press  (**Menu** soft key) on your remote control and select **Status ->Network**. The display device shows network information about the system.
- Press  on the VCP40 phone when the phone is idle and select **Network**. The LCD screen of the phone displays the network information of the system.

Log into the web user interface:

1. Enter the IP address (e.g., `http://192.168.0.10` or `192.168.0.10`) in the address bar of a web browser on your PC, and then press the **Enter** key.
2. Enter the administrator user name and password.

The default user name is "admin" (case-sensitive), and the default password is "0000".

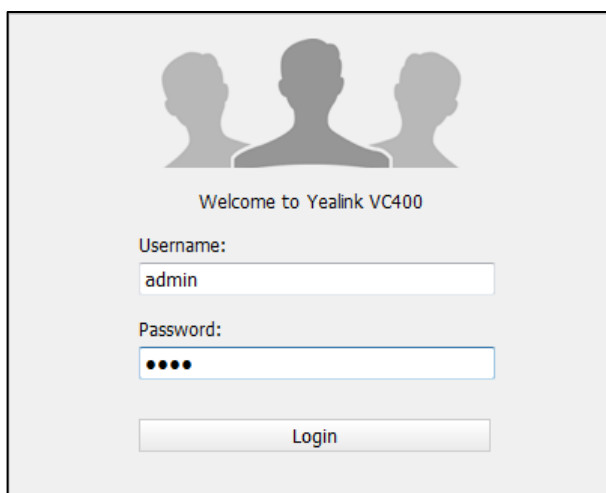

3. Click **Login**.

After you log into the web user interface successfully, you can click **Logout** on the top right corner of the web interface to log out.

Documents

The following table shows documents available for the VC400 video conferencing system.

Name	Contents	Where found	Language
Yealink VC Series Video Conferencing System Quick Start Guide	System installation and network configuration	In the package	English/Chinese
		On the website	
Yealink VC400 Video Conferencing System User Guide	System/Web user interface settings Customizing and using the system	On the website	English/Chinese
Yealink Video Conferencing System Conference Room Deployment Solution	Conference room layout, environmental requirements and installation recommendations for the system	On the website	English/Chinese
Yealink Video Conferencing System Network Deployment Solution	Network deployment for the VCS under various scenarios	On the website	English/Chinese

Note

You can also download the latest documents online:

<http://www.yealink.com/DocumentDownload.aspx?CatId=142&flag=142>

Getting Started

This chapter provides the following basic installation instructions and information for achieving the best performance from your VC400 video conferencing system. Topics include:

- [System Installation](#)
- [Powering the System On or Off](#)
- [Setup Wizard](#)
- [Registration](#)
- [Idle Screen Display](#)
- [Navigating Menus on the Display Device](#)
- [Entering Data and Editing Fields](#)
- [System Status](#)

If you require additional information, or assistance to help you use your new phone, contact your system administrator.

System Installation

This section introduces the following:

- Installing the VC400 video conferencing system
- Mounting the camera on your TV
- Mounting the camera on a wall
- Installing batteries in the remote control
- Connecting the CPE80 expansion microphone

Note

Up to two display devices can be connected to the VC400 codec. Because the display device is not included in the package, you need to purchase it separately if required. Ensure that the purchased display device supports HDMI input.

When connecting only one display device to the VC400 codec, Display1 port is the only available port. If dual screen mode is required, you can connect another display device to the Display2 port.

Because DVI cable is tailor-made, please use the Yealink-supplied DVI cable.

To prevent shock, do not connect the power adapter and turn on the power before connecting all system components.

Installing the VC400 Video Conferencing System

Do the following:

1. Connect the supplied 2m Ethernet cable to the Internet port on the VC400 codec and the switch/hub device port.
2. Connect the DVI cable to the Camera port on the VC400 codec and the camera.
3. Connect the supplied Ethernet cable with Audio In label to the Audio In port on the VC400 codec and Audio Out port on the VC400 phone.
4. Connect the HDMI cable to the Display1 port on the VC400 codec and the HDMI port on the display device.
5. Connect the power line for the display device.
6. (Optional.) Connect the VGA cable to the PC port on the VC400 codec and a PC.
7. Connect the power adapter to the DC19V port on the VC400 codec and power outlet.

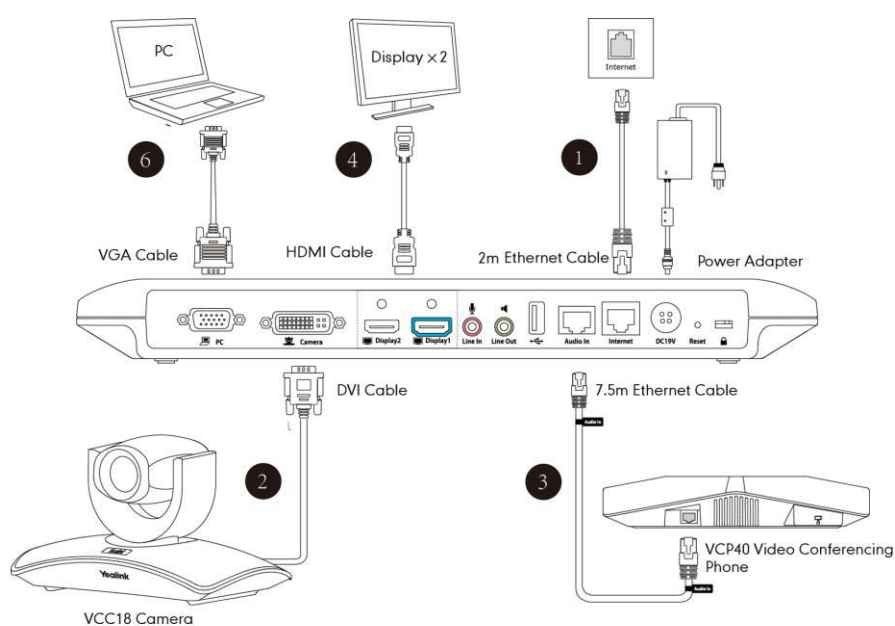

You can fasten all cables with cable ties after all devices are connected.



Installing the Camera

You can choose to mount the camera on your TV or a wall, depending on your actual needs.

a) Mounting the camera on a TV

When your TV is less than 120 mm thick, you can mount the camera on your TV.

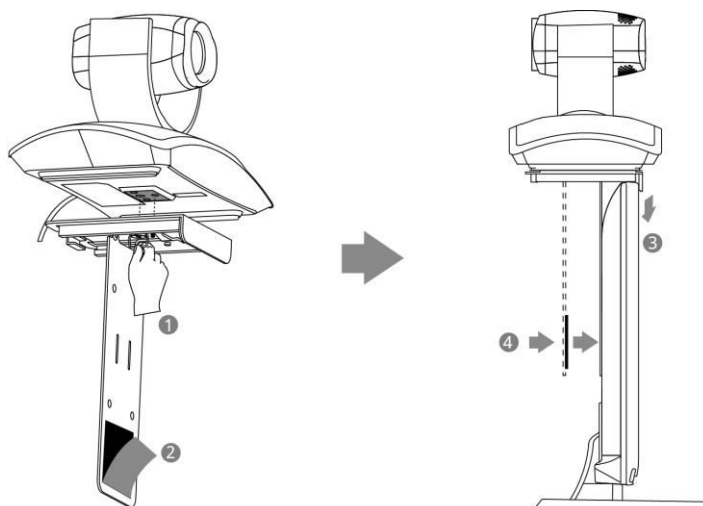

Do the following:

1. Lock the camera to the L-bracket.
2. Tear out the sticker on the L-bracket.
3. Put the L-bracket on the top of the TV.
4. Adjust the L-bracket to ensure close adhesion to the back of the TV.

b) Mounting the camera on a wall

You can also decide to mount the camera on the wall. The recommended height for camera positioning is 1.5m-1.8m above the ground.

Do the following:

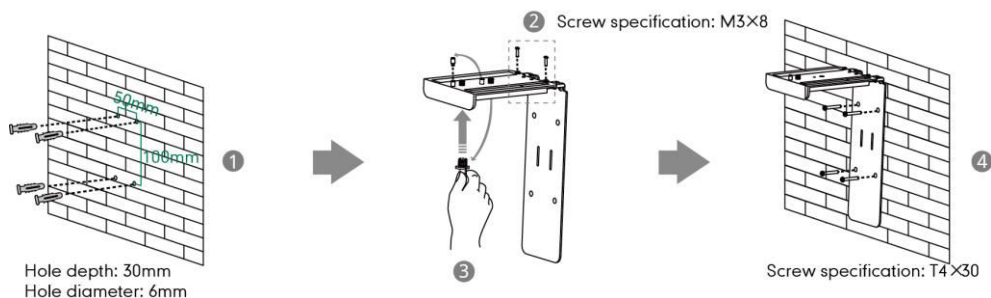

1. Punch holes into the wall and then insert the expansion bolts.
Installation location of the expansion bolts and punching requirement are shown

above.

2. Lock the L-bracket with the M3×8 screws.
3. Move the setscrews on the L-bracket to the left holes.
4. Lock the L-bracket to the wall with T4×30 screws.
5. Connect one end of the DVI cable to the camera and put the other end of the cable through the L-bracket.

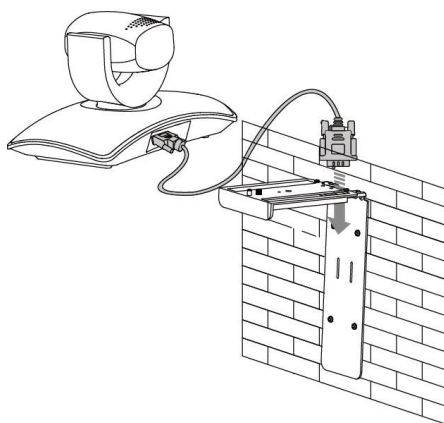

6. Lock the camera to the L-bracket, and then connect the other end of the DVI cable to the VC400 codec.

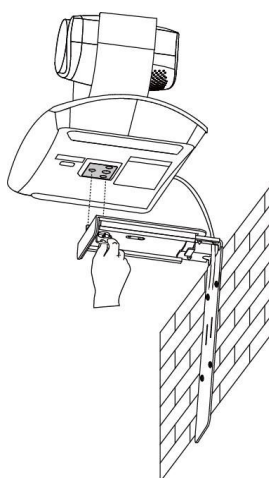

Installing Batteries for the Remote Control

Do the following:

1. Open the battery cover on the back of the remote control.
2. Insert the batteries with correct polarity.

3. Replace the battery cover.

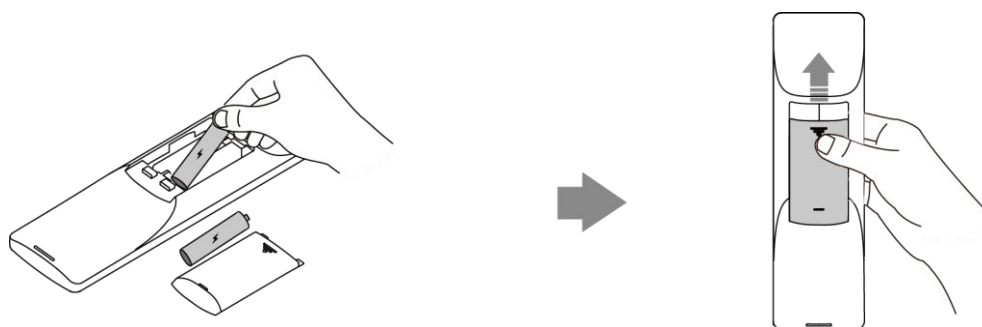

Note

Dispose of waste batteries properly.

Remove the batteries if they are not in use for a long period of time.

Connecting the CPE80 Expansion Microphone

If your video conferencing room is large, you can add an extra CPE80 expansion microphone to the MIC port on the VCP40 phone to expand the audio range of the conference phone. VCP40 phone has two MIC ports. This allows you to connect a CPE80 expansion microphone to one of the ports, depending on the location of the speaker.

CPE80 is a directional microphone. Its coverage range is a 60 degree. Always ensure that the speaker faces the expansion microphone.

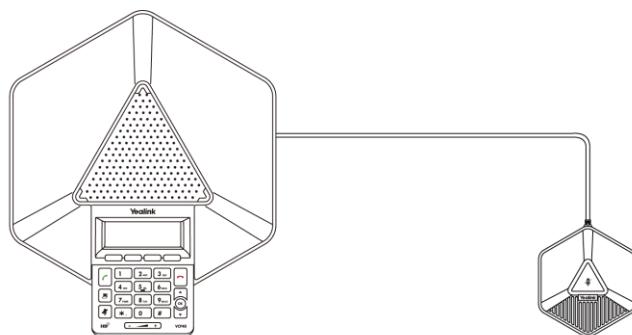

VCP40 Video Conferencing Phone

CPE80 Expansion Microphone

Powering the System On or Off

Note



Caution! In order to avoid corrupting the system, you should always power off the system using the power button on the codec. After turning the power off in this way, wait at least 15 seconds before you unplug the system from its power source. This helps ensure that the system powers off correctly.

To power on the system:

After all components are connected, press  on the VC400 codec. The indicator LED on the VC400 codec then illuminates solid green.

To power off the system:

Do one of the following:

- Long press  on the VC400 codec.
- Short press , the display device will prompt " Press the power button to turn off the system. Press any button on remote control to cancel".

Press  again to power off the system or press any button on the remote control to cancel.

Setup Wizard

When you first start up, or upgrade or reset the system, the display device will display the setup wizard.

To configure the setup wizard via the remote control:

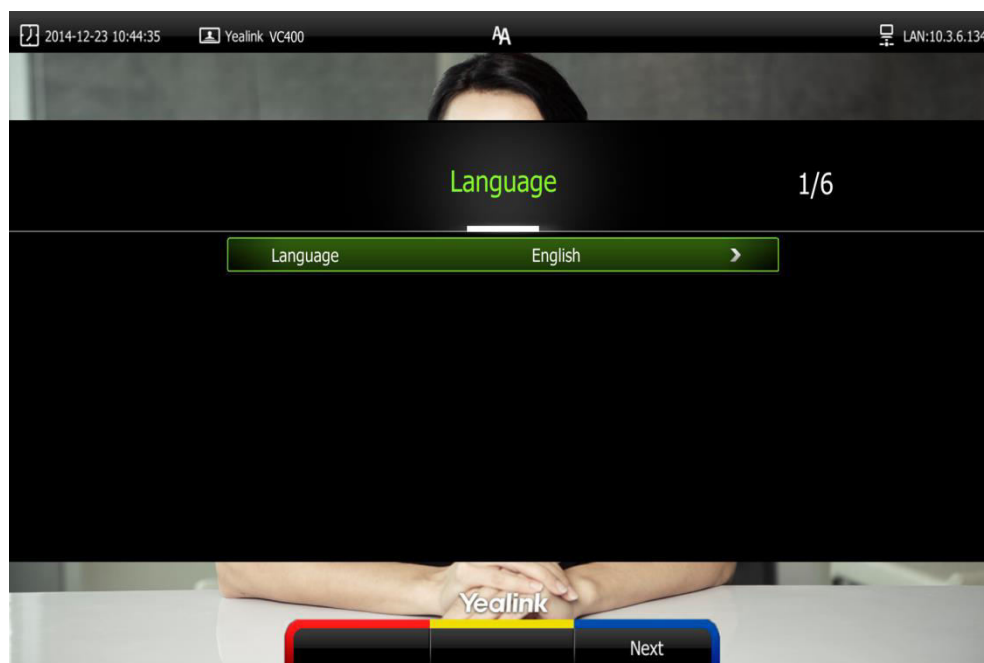

1. Set the language displayed on the display device.
The default language is English.

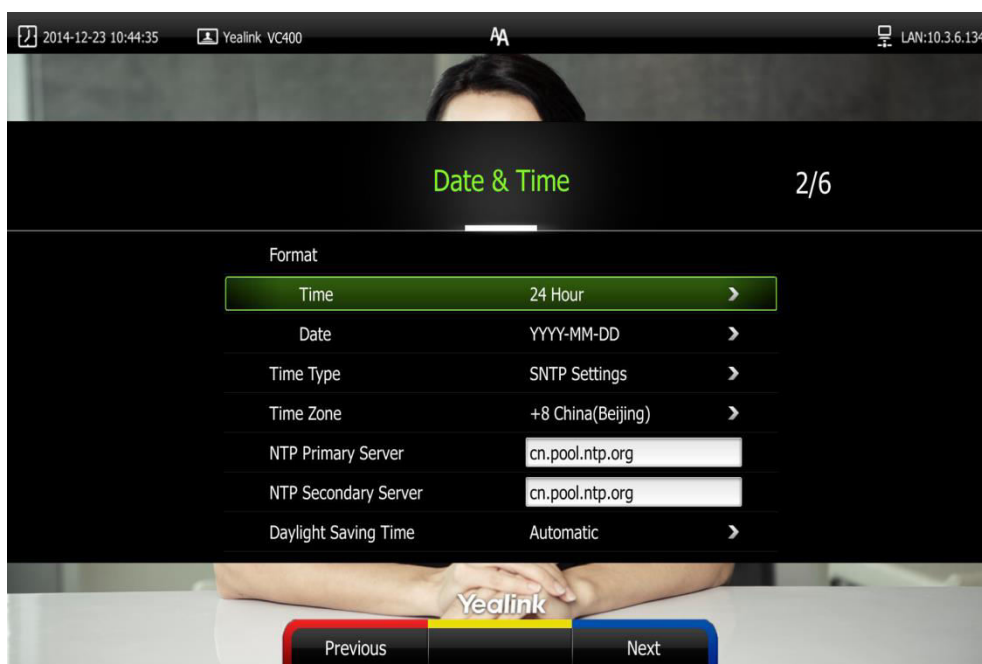

2. Press  (Next soft key) to continue.

3. Set the date and time.





4. Press  (**Next** soft key) to continue or press  (**Previous** soft key) to return to the previous screen.

5. Edit the site name.

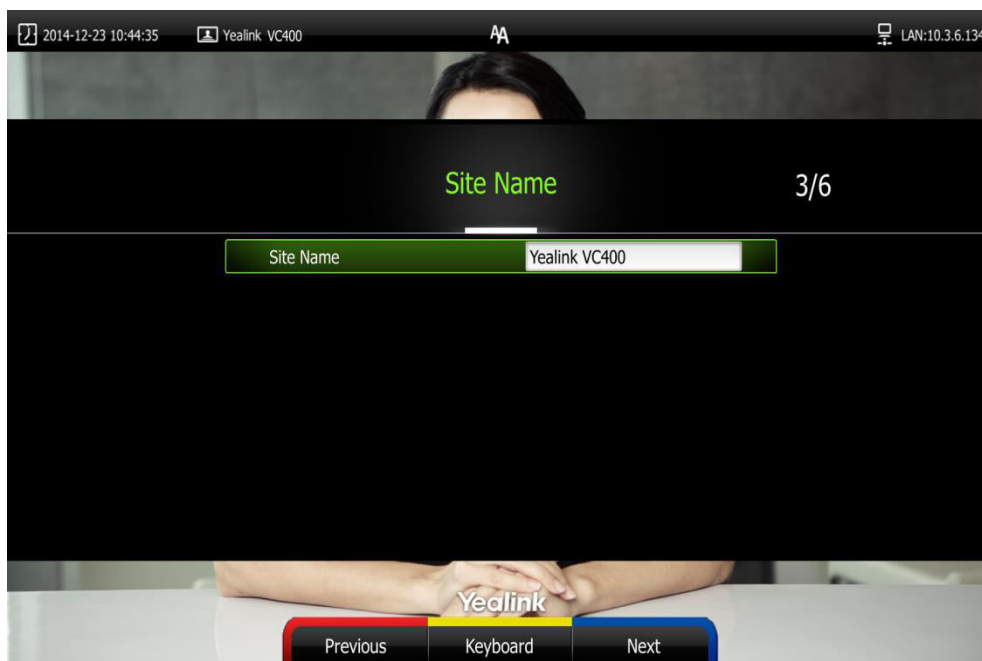
The default site name is "Yealink VC400".





6. Press  (**Next** soft key) to continue or press  (**Previous** soft key) to return to the previous screen.

7. Change the administrator password.

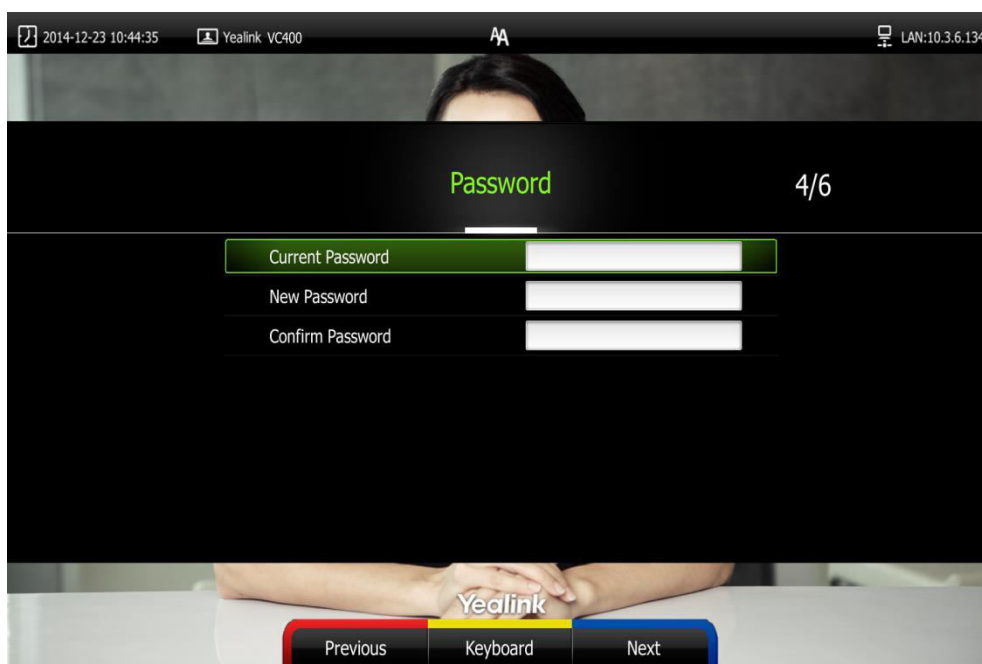

The default administrator password is "0000".

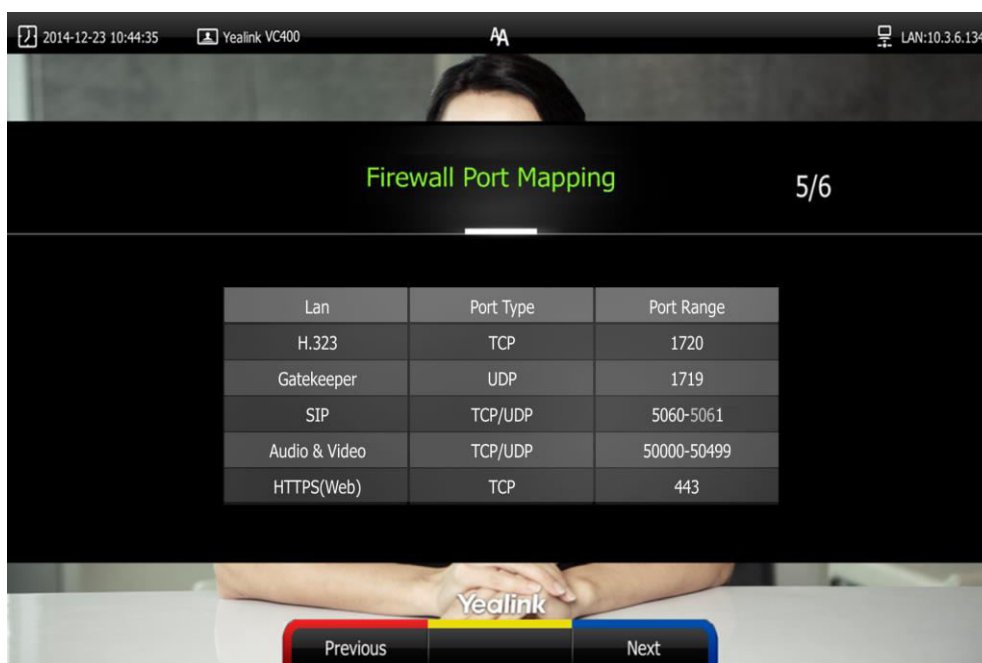

8. Press  (**Next** soft key) to continue or press  (**Previous** soft key) to return to the previous screen.

The display device shows firewall port mapping information.



9. Press  (**Next** soft key) to continue or press  (**Previous** soft key) to return to the previous screen.
10. Configure network settings.

The phone will attempt contact a DHCP server in your network to obtain an IP address, subnet mask, default gateway address and DNS address by default. If you uncheck the DHCP checkbox, you will then need to configure network settings manually.

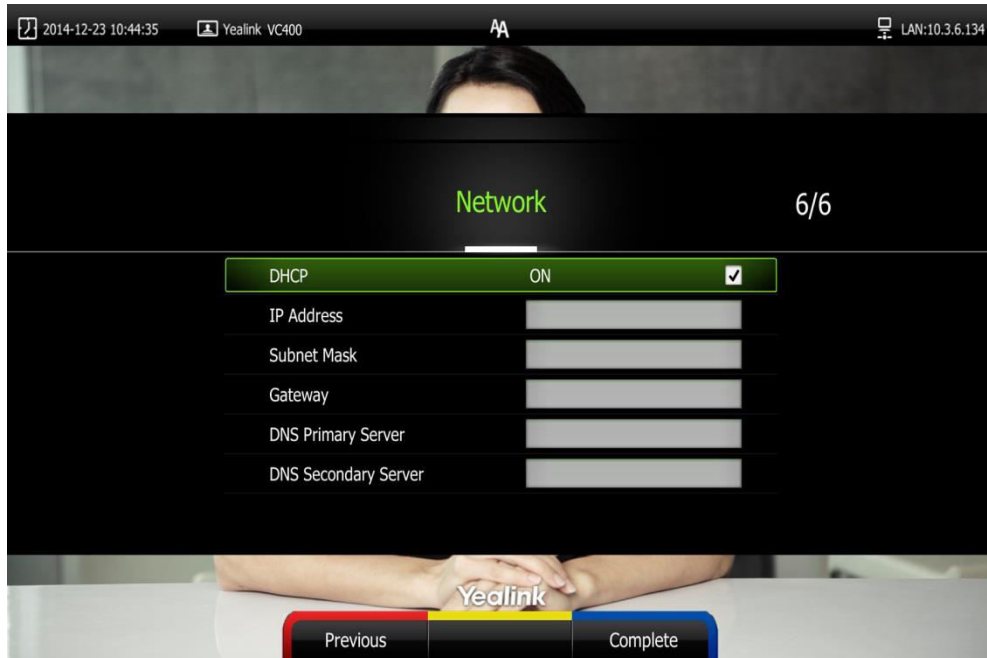

11. Press  (**Complete** soft key) to complete the setup wizard.

For more information about how to configure system features using the remote control, refer to [Navigating Menus on the Display Device](#) on page 27 and [Entering Data and Editing Fields](#) on page 28. For more information about how to configure language, time and date, refer to [Customizing the VC400 Video Conferencing System](#) on page 33.

Note

Wrong network settings may result in the inaccessibility of your system. They may also have an impact on your network performance. For more information on these parameters, contact your system administrator.

Registration

Generally, your system administrator will configure the system account beforehand, so that after you start up the system, the system will already be registered and ready for use. If your system is not registered, you may have to register it. For more information about how to register an account for the system, refer to

[Yealink_VC_Series_Video_Conferencing_System_Administrator_Guide](#).

Idle Screen Display

Idle screen of the display device

If the system has successfully started up, the idle screen will be shown. The following figure is an example of what is displayed on the LCD screen:

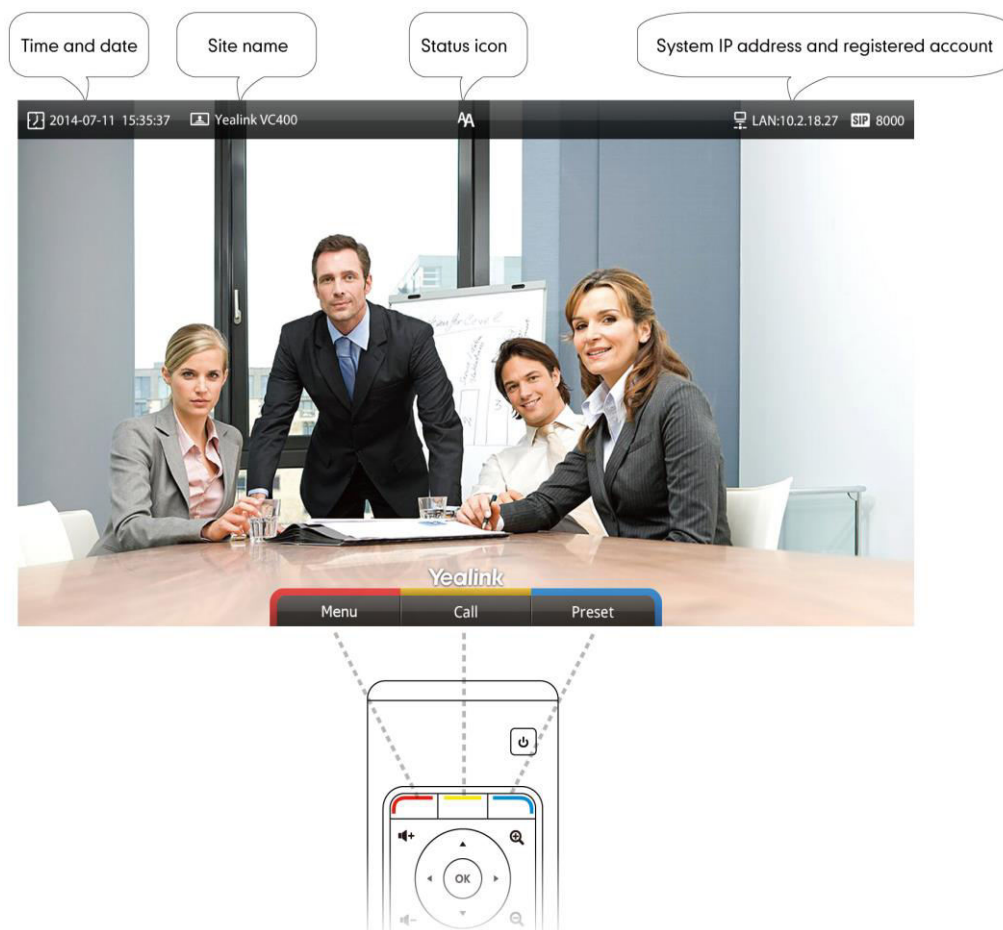

Name	Description
Time and Date	The phone's time and date are displayed on the left of the status bar.
Site name	The site name of the system.
Status icon	Status icons are displayed in the center of the status bar.
System IP address and registered account	IP address and registered account are displayed on the right of the status bar.
Video image	Video image is displayed.
Soft keys	The display device shows the names of shortcut keys, and users can press these shortcut keys on the remote control to execute corresponding

Name	Description
	action.

Idle screen of the VCP40 phone

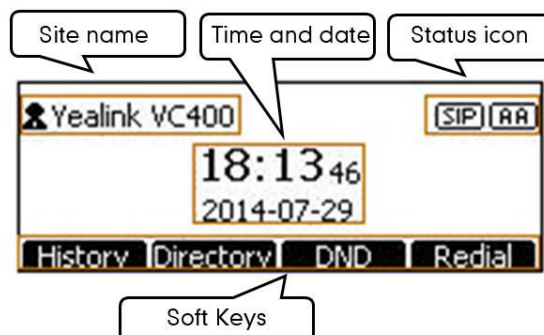





Name	Description
Status icon	Displays the phone's status.
Soft Keys	Displays four soft keys. <ul style="list-style-type: none"> • History: Enters the History screen • Directory: Enters the Directory screen • DND: Enables or disables the Do Not Disturb mode • Redial: Redials the last dialed number
Site name	Displays the site name.
Time and Date	Displays the time and date.



Navigating Menus on the Display Device

You can press the keys on remote control to enter the main menu screen, and view the items on the display device.

Note The menu system will automatically return to the idle screen after 60 seconds of inactivity.

To navigate menus and fields, you can:

If you want to	You can
Enter the main menu.	Press  .
Return to the idle screen.	Press  .
Go back to the previous menu.	Press  or  .









If you want to	You can
Navigate through menus.	Press ◀ or ▶ to select a menu. Press ▲ or ▼ to select an item.
Expand pull-down menu	Press  or ▶ to expand a pull-down list
Select an option from the pull-down list	From the pull-down list, Press ▲ or ▼ to scroll to the setting and then press  .
Enable or disable features	Press  .



Entering Data and Editing Fields

You can enter data and edit fields using the keypad on the remote control or the on-screen keyboard on the display device:

To enter or edit data:

1. Select the field.
2. Do one of the following:

If you want to	You can
Entering numbers	Press the digit keys on the remote control.
Entering letters	<ol style="list-style-type: none"> 1. Press  to open the on-screen keyboard. In the dialing screen, press  to open the on-screen keyboard. 2. Press the navigation keys on the remote control to select desired letters. 3. Press . <p>You can press  to switch input method or press  to exit from the on-screen keyboard.</p>
Entering special characters	<ol style="list-style-type: none"> 1. Press  to open the on-screen keyboard. In the dialing interface, press  to open the on-screen keyboard. 2. Press  to switch the input method to @#%. 3. Press the navigation keys on the remote control to select desired characters. 4. Press .

If you want to	You can
	5. You can press  to exit from the on-screen keyboard.
Delete text you entered.	Select the field, press  to delete the entered text, or you can long press  for 2 seconds to delete the entire field of text.

3. Press  to save.

System Status

When the system is idle, you can view its status via the remote control, VCP40 phone or web user interface.

Available system status information includes:

- **System information** (device model, firmware, hardware version, product ID and serial number)
- **Network status** (LAN type, IP address, MAC, subnet mask, gateway and DNS server, public IP address can also be viewed if the static NAT is enabled)
- **Account status** (register status of SIP account and H.323 account)
- **Camera** (status, device model, SPEC, hardware version and serial number)
- **Audio** (the active audio input and output devices)
- **VCS Phone** (status, device model, hardware version and serial number)

To view the system status via the remote control:

1. Press  (**Menu** soft key).
The display device shows the **Status** menu.

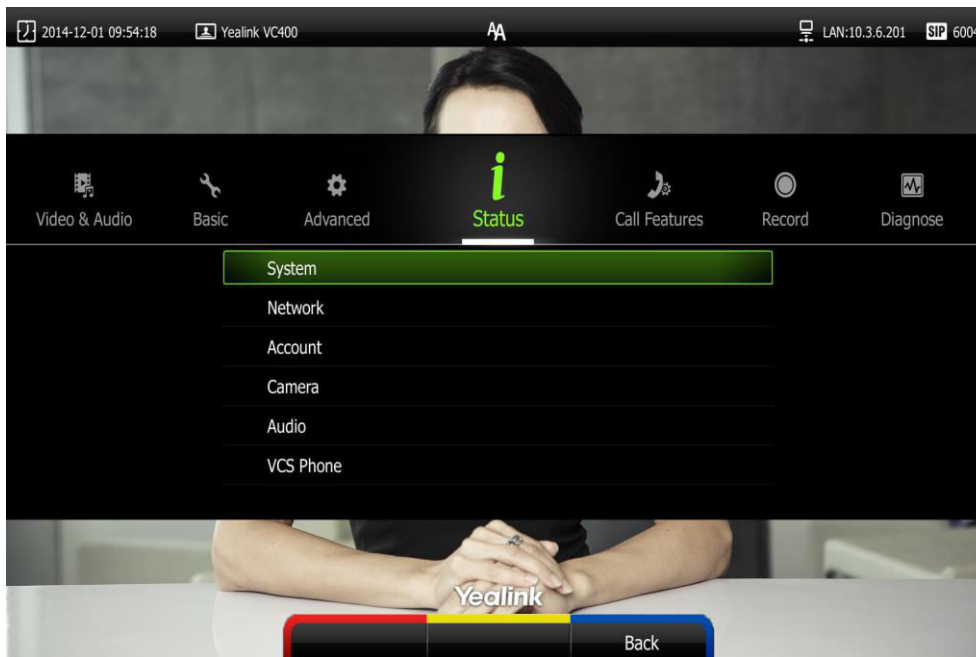

2. Press ▲ or ▼ to select the desired list.
3. Press  to view the specific information.

To view the system status via the web user interface:

1. Click **Status**.

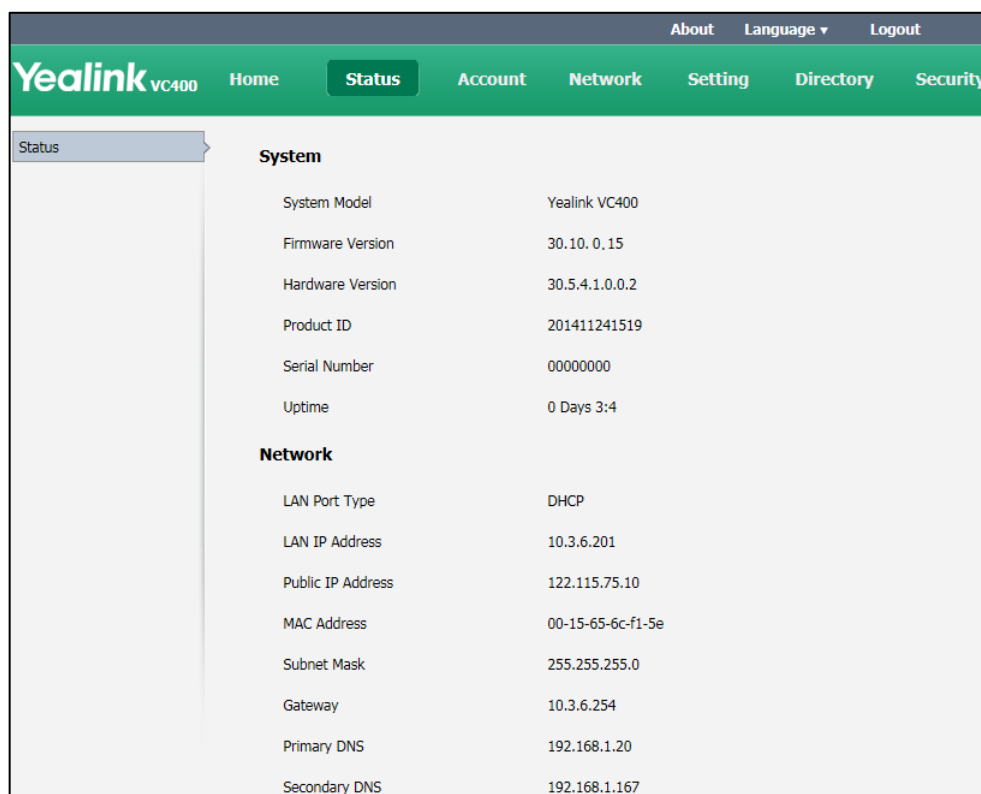

The system status is displayed on the web user interface.

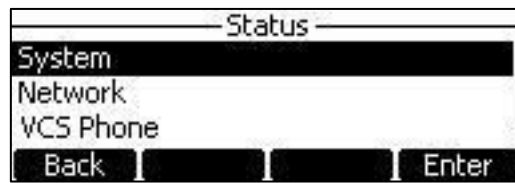

To view the system status via phone user interface:

1. Press .



2. Press  or  to select the desired list.
3. Press  or the **Enter** soft key to view the specific information.

Customizing the VC400 Video Conferencing System

You can customize your VC400 video conferencing system by personally configuring certain settings, for example, site name, time & date and language. You can add contacts to the local directory manually or from the call history.

This chapter provides basic operating instructions for customizing your system. Topics include:

- [General Settings](#)
- [Local Directory](#)
- [Call History Management](#)
- [Call Type](#)
- [Bandwidth Settings](#)
- [Audio Setting](#)
- [Far-end Camera Control](#)

If you require additional information or assistance with your new system, contact your system administrator.

General Settings

Automatic Sleep Time

The system will enter the sleep mode automatically when it has been inactive for a period of time (the default period is 10 minutes).

When the system is in sleep mode, it will still accept incoming calls. The display device will prompt “No Signal”, and the VCP40 phone LCD screen prompts “Sleeping Press any key to resume”. You can press any key on the remote control or VCP40 phone to wake the system up. When receiving a call, the system will be woken up automatically.

You can change the automatic sleep time via the remote control or web user interface. You can also press the sleep key on the remote control to make the system sleep immediately.

To configure the automatic sleep time via the remote control:

1. Press  (Menu soft key) to enter main menu.
2. Press ◀ or ▶ to select the **Basic** menu.

3. Press ▲ or ▼ to scroll to **Automatic Sleep Time**, and then press .
4. Select desired time from the pull-down list of **Automatic Sleep Time**.
If **Always On** is selected, the system will not enter the sleep mode automatically.

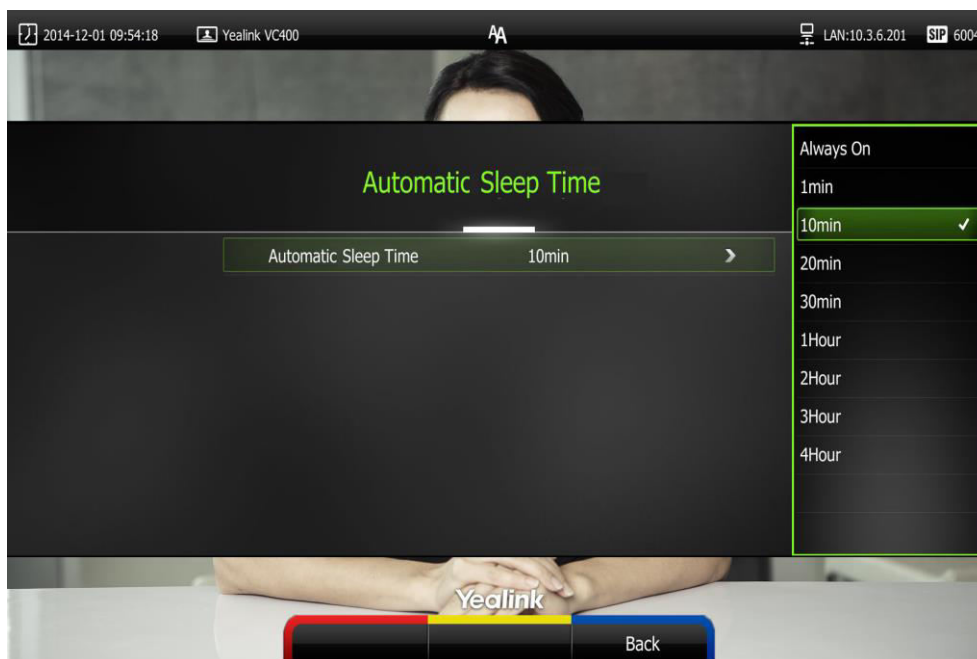

5. Press  (**Save** soft key) to accept the change.

Automatic sleep time can be configured via the web user interface at the path **Setting->General->Automatic Sleep Time**.

Backlight

The backlight of the VCP40 phone is always on by default. You can configure backlight time for the VCP40 phone's LCD screen via the web user interface.

You can configure the LCD screen's backlight time in the following formats:

- **Always On:** Backlight is on permanently.
- **15s, 30s, 1 Min, 2 Min, 5 Min, 10 Min, 30 Min:** Backlight goes out when the phone has been inactive for the time you set.

To configure the backlight via the web user interface:

1. Click on **Setting ->General**.

2. Select the desired value from the pull-down list of **Backlight Time**.

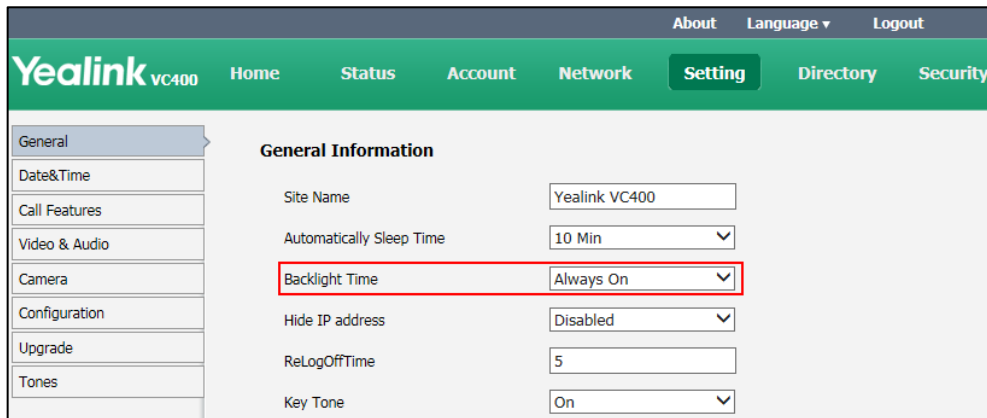





3. Click **Confirm** to accept the change.

Site Name

Site name is displayed on the status bar of the display device and VCP40 phone. When you make an IP address call to the other party, the site name will be displayed on the remote display device. Site names can consist of letters, numbers or special characters. Site name can be configured via the remote control or web user interface.

To configure the site name via the remote control:

1. Press  (**Menu** soft key) to enter main menu.
2. Press  or  to select the **Basic** menu.
3. Press  or  to scroll to **Site Name**.
4. Edit the site name.

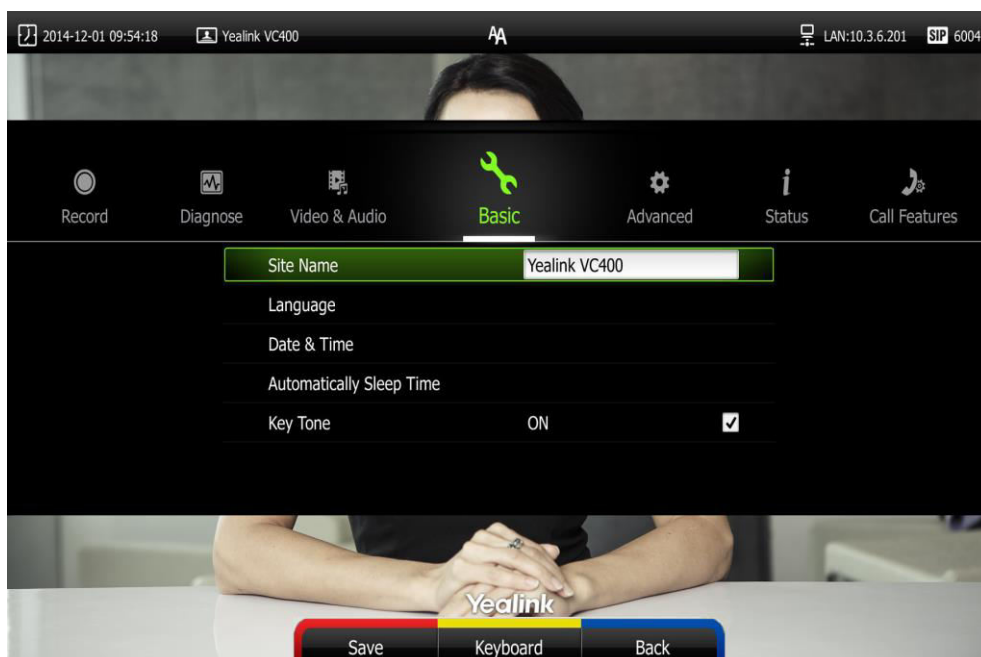

5. Press  (**Save** soft key) to accept the change.



Site name can be configured via the web user interface at the path **Setting->General->Site Name**.

Language

The default language of the display device is English, and you can change it via the remote control. The VCP40 phone will detect and use the same language as which of the display device.

The default language of the web user interface is English. You can change the web user interface via web user interface language. The available languages for the system are English, Chinese_S, Chinese_T, French, German, Italian, Polish, Portuguese, Spanish, Turkish and Russian.

To change the language on the display device via the remote control:

1. Press  (**Menu** soft key) to enter main menu.
2. Press ◀ or ▶ to select the **Basic** menu.
3. Press ▲ or ▼ to scroll to **Language**, and then press .
4. Select the desired language from the pull-down list of **Language**.

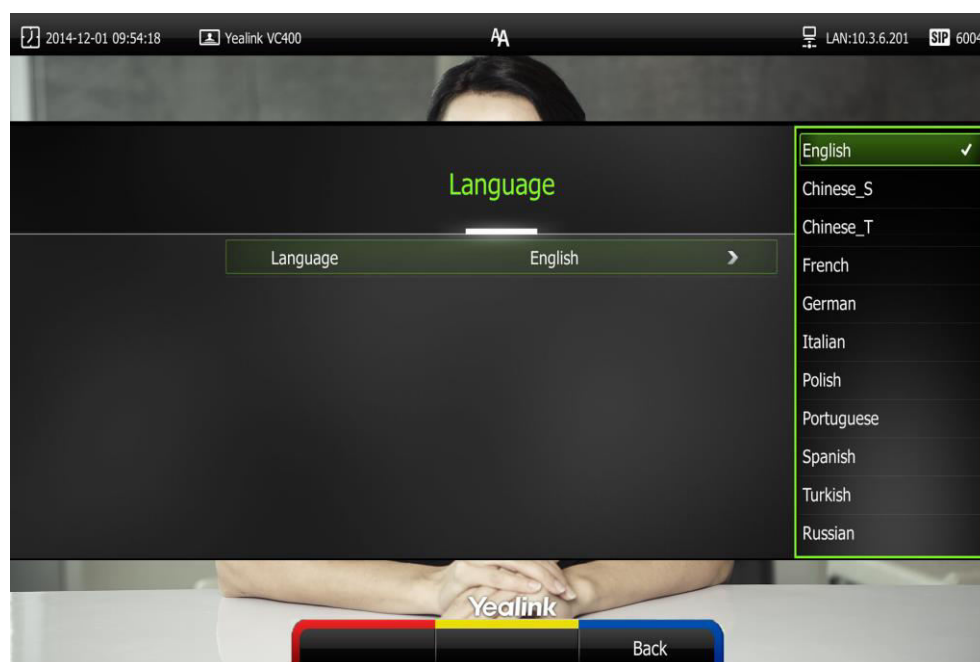

5. Press  (**Save** soft key) to accept the change.

Text displayed on the display device and VCP40 phone LCD screen will change to the selected language.

To change the language for the web user interface:

1. Click on **Language** at the top right corner of the web page.

2. Select the desired language from the pull-down list of **Language**.

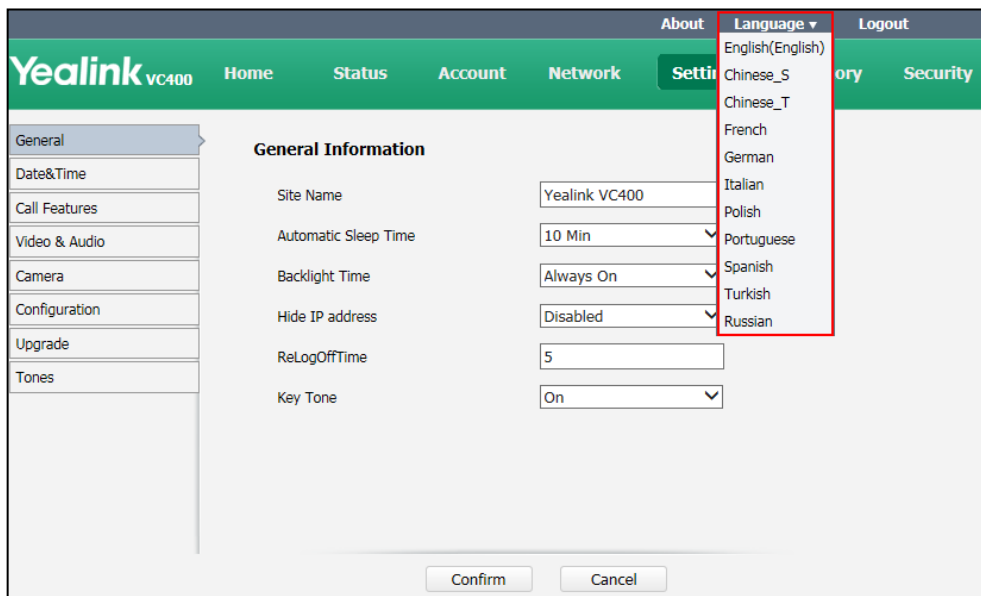

Text displayed on the web user interface will change to the selected language.

Time & Date

The time and date are displayed on the LCD screen of the VCP40 phone and display device. You can configure the system to obtain the time and date from the SNTP (Simple Network Time Protocol) server automatically.



If the phone cannot take the time and date from the SNTP server, you can configure the time and date manually, or contact your system administrator for more information.

There are 7 available date formats. For example, for the date format “WWW DD MMM”, “WWW” represents the abbreviation of week. “DD” represents the two-digit day, and “MMM” represents the first three letters of the month.

The available date formats you need to know are:

Date Format	Example (2015-1-28)
WWW MMM DD	Wed Jan 28
DD-MMM-YY	28-Jan-15
YYYY-MM-DD	2015-01-28
DD/MM/YYYY	28/01/2015
MM/DD/YY	01/28/15
DD MM YYYY	28 Jan 2015
WWW DD MMM	Wed 28 Jan

To configure the NTP server and date & time format via the remote control:

1. Press  (**Menu** soft key) to enter main menu.
2. Press ◀ or ▶ to select the **Basic** menu.
3. Press ▲ or ▼ to scroll to **Date & Time**, and then press .
4. Select the desired time format from the pull-down list of **Time**.
5. Select the desired date format from the pull-down list of **Date**.
6. Select **Sntp Settings** from the pull-down list of **Time Type**.
7. Select the time zone that applies to your area from the pull-down list of **Time Zone**.

The default time zone is "+8 China(Beijing)".

8. Enter the domain names or IP addresses in the **NTP Primary Server** and **NTP Secondary Server** fields respectively.
9. Select the desired value from the **Daylight Saving Time** field.

When **Automatic** is selected, the system will use daylight saving time corresponding to the selected time zone.

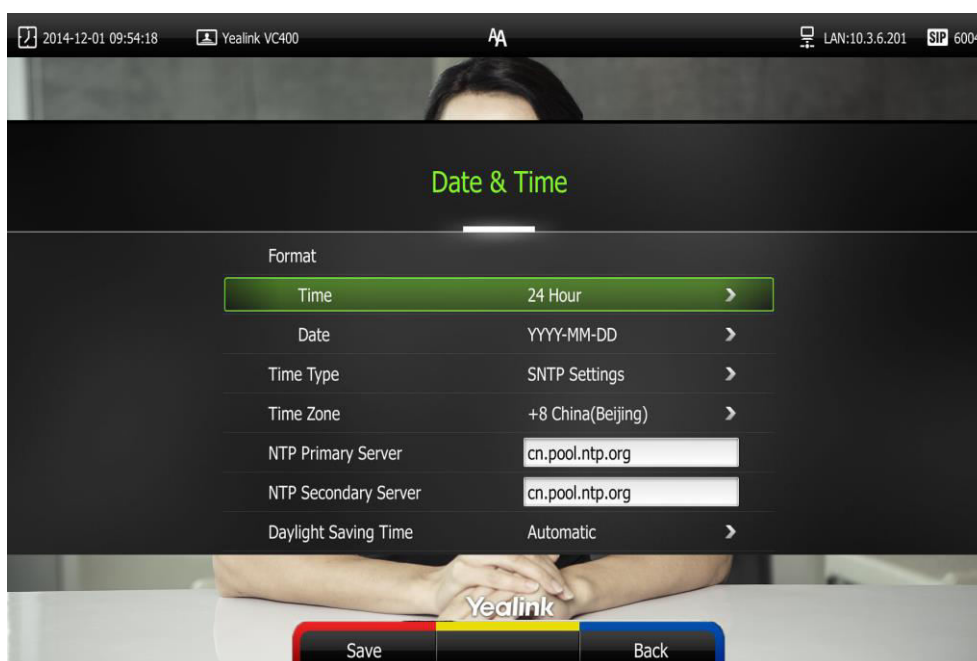



10. Press  (**Save** soft key) to accept the change.

Note

Please refer to [Appendix A - Time Zones](#) for the list of available time zones on the system.

To configure the time and date manually via the remote control:

1. Press  (**Menu** soft key) to enter main menu.
2. Press ◀ or ▶ to select the **Basic** menu.
3. Press ▲ or ▼ to scroll to **Date & Time**, and then press .
4. Select the **Manual Settings** from the pull-down list of **Time Type**.

5. Select the desired year from the pull-down list of **Year**.
6. Select the desired month from the pull-down list of **Month**.
7. Select the desired day from the pull-down list of **Day**.
8. Select the desired hour from the pull-down list of **Hour**.
9. Select the desired minute from the pull-down list of **Minute**.
10. Select the desired second from the pull-down list of **Second**.

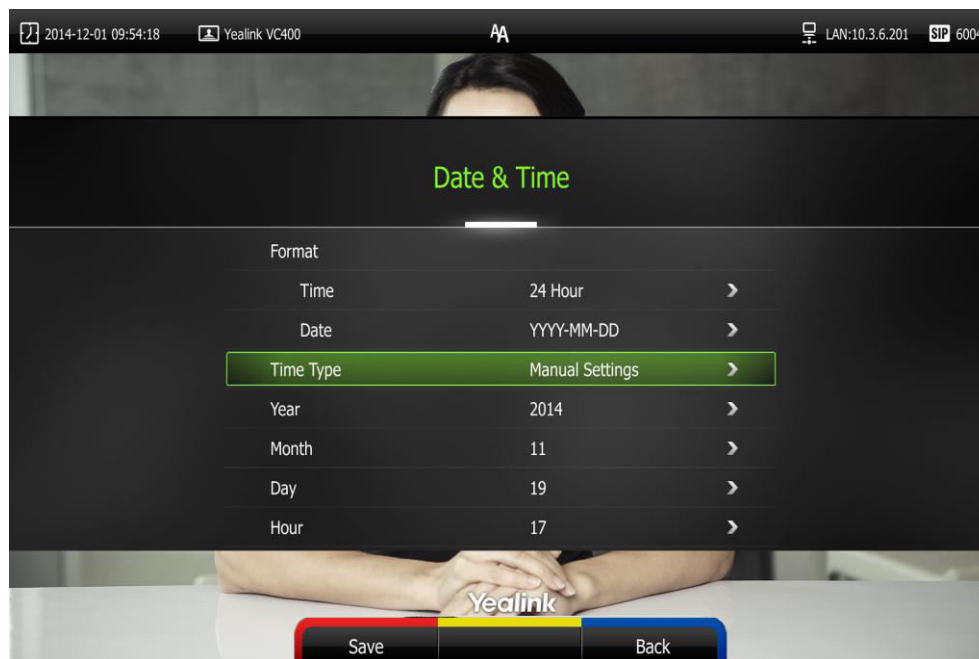

11. Press  (**Save** soft key) to accept the change.



Time and date can be configured via the web user interface at the path **Setting->Date**.

Key Tone

You can switch on the key tone feature for the system to play a key tone when you press the key on the remote control.

Key tone can be configured via the remote control or web user interface. Key tone feature is enabled by default.

To configure the key tone via the remote control:

1. Press  (**Menu** soft key) to enter main menu.
2. Press  or  to select the **Basic** menu.

3. Press ▲ or ▼ to scroll to **Key Tone**, and then press **OK** to enable or disable this feature.

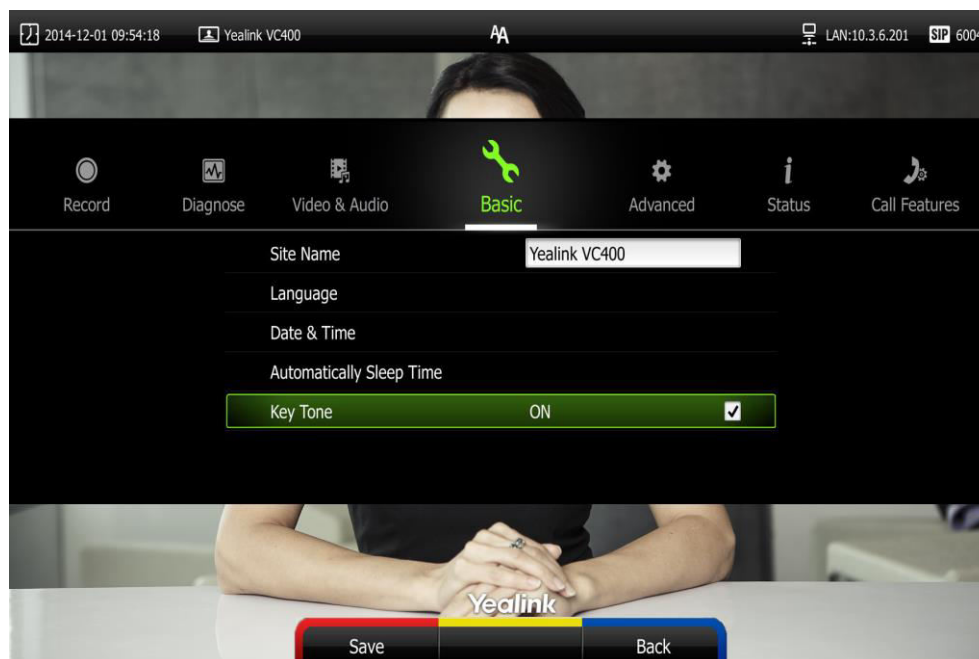

4. Press  (Save soft key) to accept the change.

Key tone can be configured via the web user interface at the path **Setting->General->Key Tone**.

Audio Settings

You can use the remote control or VCP40 phone to adjust the ringer volume of the system. You can also adjust the receiver volume of engaged audio devices when the system is in use.

To adjust the volume when the system is idle:

Do one of the following:

- Press  or  on the remote control to adjust the ringer volume of the system.

The current ringer volume of the system is displayed on the left of the display device.

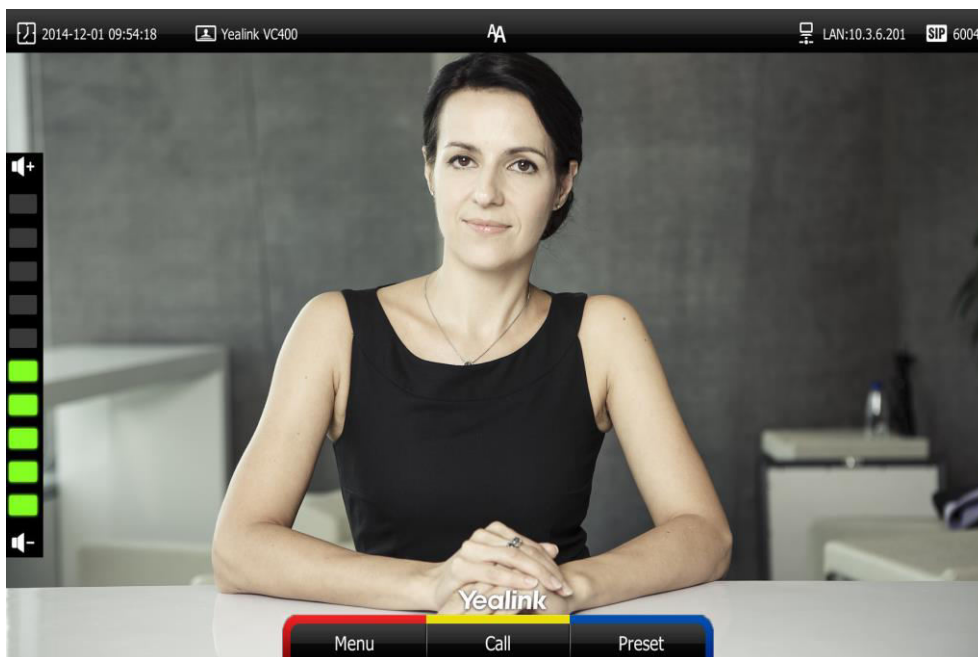

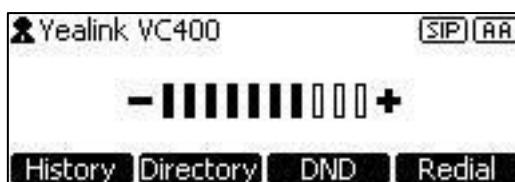

- Press  on the VCP40 phone to adjust the ringer volume. The LCD screen of the VCP40 phone displays the current ringer volume.





The display device will display the ringer volume simultaneously.

Note

If ringer volume is adjusted to 0, the  icon will appear on the display device. The  icon will appear on the LCD screen of the VCP40 phone.

To adjust the volume when the system during a call:

- Press  or  on the remote control to adjust the receiver volume of the system.

The current receiver volume of the system is displayed on the left of the display device.



- Press  to adjust the receiver volume.
The LCD screen of the VCP40 phone displays the current receiver volume.



The display device will display the receiver volume simultaneously.

Note If the VCP40 phone is not the active audio device of the system, you can still use it to adjust the system volume.

Local Directory

You can add local contact and conference contact information to the system. Conference contact consists of one or more local contacts (at least one, at most three). You can create a conference with other parties (up to 4 parties, including yourself). VC400 system can store up to 500 local contacts and 100 conference contacts. You can manage the local directory via the remote control or web user interface.



This chapter provides operating instructions for the local directory. Topics include:

- [Adding Contacts](#)
- [Placing Calls to Contacts](#)
- [Editing Contacts](#)
- [Deleting Contacts](#)
- [Searching for Contacts](#)
- [Search Source List in Dialing](#)
- [Importing/Exporting Contact Lists](#)

Adding Contacts

You can add local contact and conference contact information to the system via the remote control or web user interface.

To add a local contact via the remote control:

1. Press  (**Call** soft key).
2. Press ◀ or ▶ to select the **Directory** menu.
3. Press  (**New Contact** soft key).
4. Enter contact name in the **Name** field.
5. Enter contact number or IP address in the **Number** field.
6. Press ▲ or ▼ to scroll to **Add New Number**, and then press  to add more numbers.

Up to 3 numbers can be added to a contact.

7. Enter the second number of the contact in the **Number 2** field.

You can repeat step 6 to add the third number to the contact, and enter the third number in the **Number 3** field.

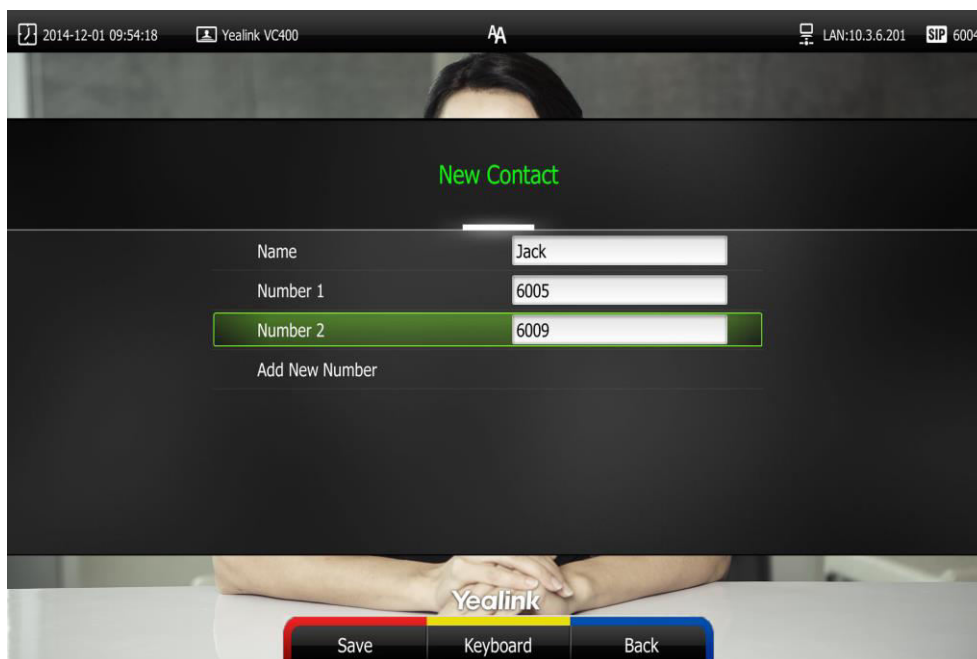



8. Press  (**Save** soft key) to save the local contact.

Note

If the contact already exists in the directory, the display device will prompt "Contact already exists!".

To add a conference contact via the remote control:

1. Press  (**Call** soft key).
2. Press ◀ or ▶ to select the **Directory** menu.
3. Press  (**New Conference** soft key).
4. Enter conference name in the **Name** field.
5. Press ▲ or ▼ to scroll to **Add Member**.
6. Enter a few characters of the contact name or the contact number in the **Add Member** field.

Contacts whose name or number matches the characters entered will appear on the screen.

7. Press ▲ or ▼ to select the desired local contact.
8. Press  to add the desired local contact to the **Member List**.

Repeat steps 7 to 8 to add more contact to the **Member List**.

You can also add conference contacts directly without searching action: press ▲ or ▼ to select the desired local contact, and then press  to add the desired local contact to the **Member List**.

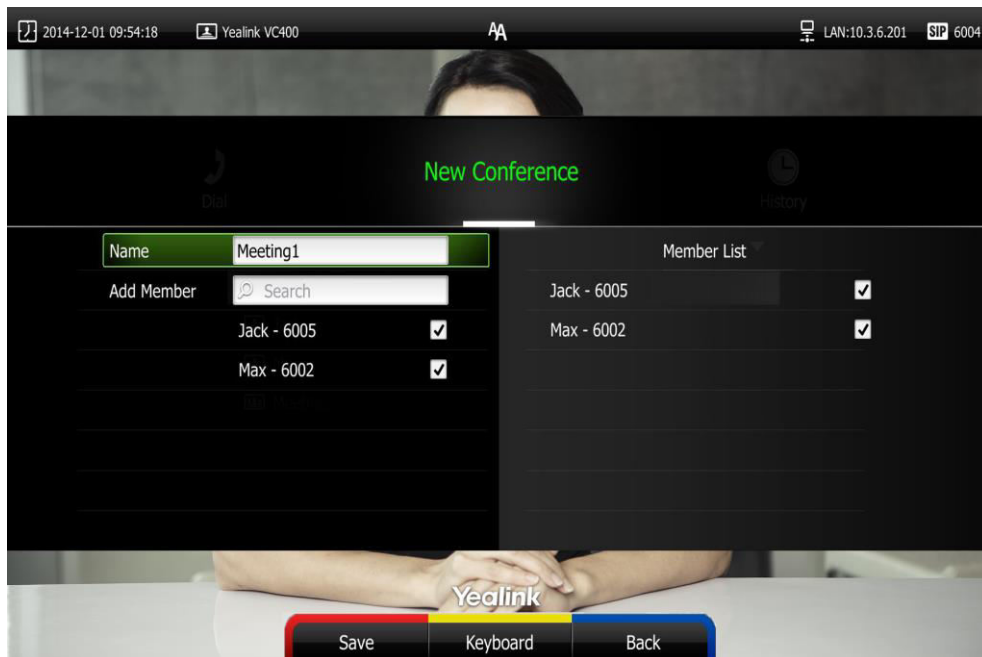





9. Press  (**Save** soft key) to save the conference contact.

Adding contacts can be configured via the web user interface at the path **Account->Register**.

Placing Calls to Contacts

You can place calls to local contacts or conference contacts via the remote control, VCP40 phone or web user interface.

To place a call to a local contact via the remote control:

1. Press  (**Call** soft key).
2. Press ◀ or ▶ to select the **Directory** menu.
3. Press ▲ or ▼ to select the desired local contact.
4. Press  .
 - If only one number is stored for the contact, the contact number will be dialed out directly.
 - If multiple numbers are stored for the contact, press ▲ or ▼ to highlight the desired number, and then press  or  to dial out the number.

To place a call to a conference contact and create a conference:

1. Press  (**Call** soft key).
2. Press ◀ or ▶ to select the **Directory** menu.
3. Press ▲ or ▼ to select the conference contact.

You can also select **Conference** from the pull-down list of **All Contacts**, and then press ▲ or ▼ to highlight the conference contact



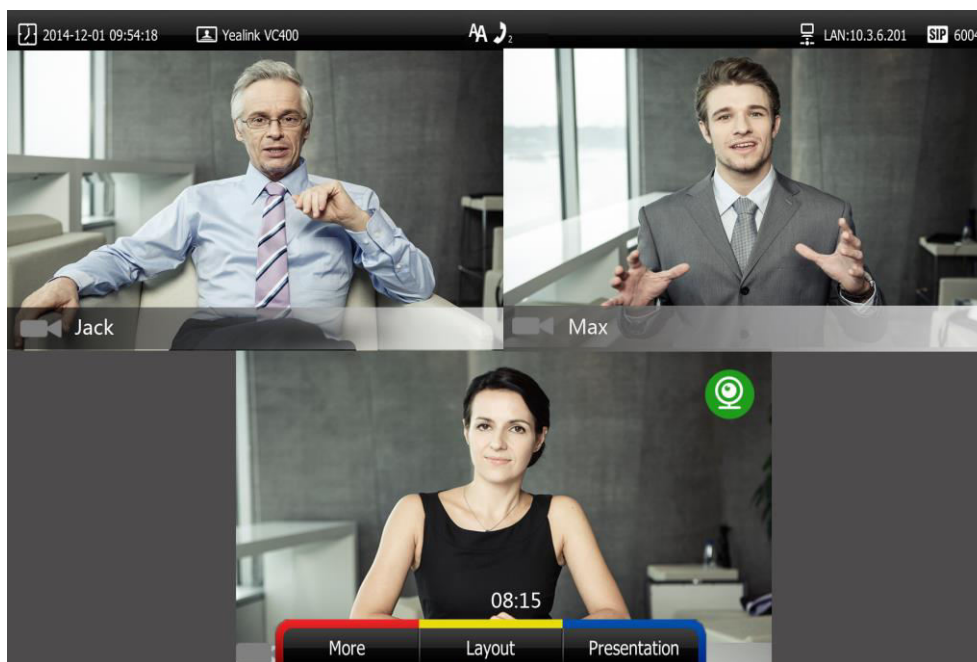

4. Press  or .

The system will call the first member of the conference contact. When the first member answers the call, the system will call the second member and repeat this until all conference members have joined to the conference.





When the system set up a conference successfully, the display device is shown as below:



To place a call to a local contact via the VCP40 phone:







1. Press the **Directory** soft key to enter the Directory list.
2. Press  or  to select the desired directory list (**All Contacts** or **Local**).
3. Press the **Enter** soft key or  to view the contacts in the selected directory.
4. Press  or  to select the desired contact.

You can press the ◀ or ▶ soft key to switch the directory list.

5. Do one of the following:
 - If only one number is stored for the contact, press the **Send** soft key,  or  to call the contact.
 - If multiple numbers are stored for the contact, press the **Enter** soft key or  to view the contact numbers.
Press ▲ or ▼ to highlight the desired number.
Press the **Send** soft key,  or  to call the contact.

To place a call to conference contact via the VCP40 phone:

1. Press the **Directory** soft key to enter the Directory list.

2. Press  or  to select the desired directory list (**All Contacts** or **Conference**).
3. Press the **Enter** soft key or  to view the contacts in the selected directory.
4. Press  or  to highlight the desired contact.
5. Press the **Send** soft key,  or .







The system will call the first member of the conference contacts. When the first member answers the call, the system will call the second member and repeat this until all conference members have joined the conference, and the system has set up a conference successfully.

Placing calls to contacts can be configured via the web user interface at the path **Directory->Local**.

Editing Contacts



You can edit local contacts or conference contacts via the remote control or web user interface:

To edit a contact via the remote control:

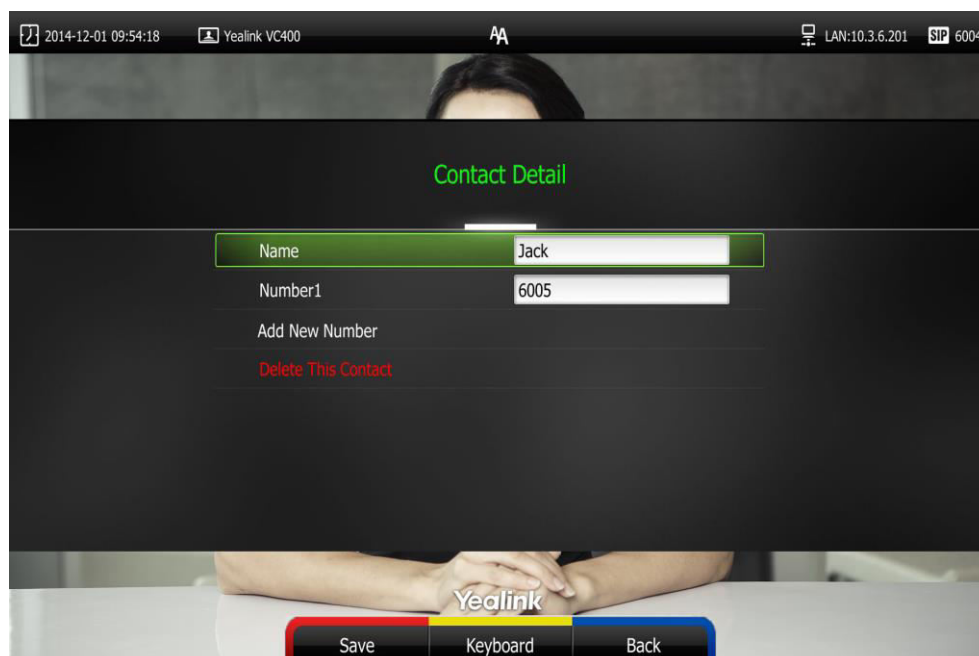

1. Press  (**Call** soft key).
2. Press  or  to select the **Directory** menu.
3. Press  or  to select the desired local contact.
4. Press  (**Detail** soft key).
5. Edit contact information.

You can select **Add New Number** to add new numbers for the contact.





6. Press  (**Save** soft key) to accept the change or press  (**Back** soft key) to cancel.

To edit a conference contact via the remote control:

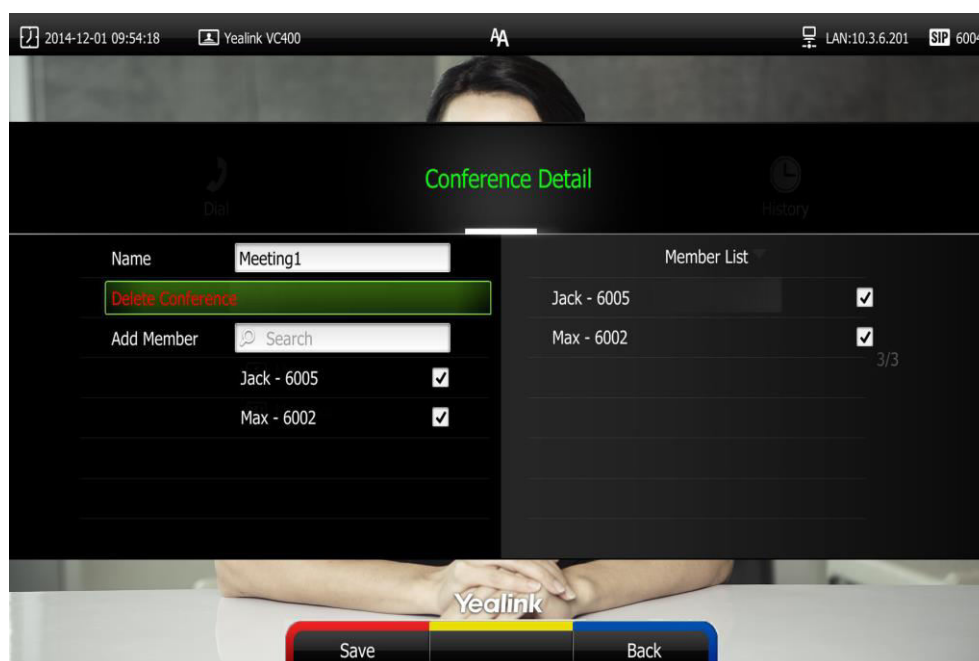
1. Press  (Call soft key).
2. Press ◀ or ▶ to select the **Directory** menu.
3. Press ▲ or ▼ to select the desired conference contact.
4. Press  (Detail soft key).
5. Edit contact information.







7. Press  (Save soft key) to accept the change or press  (Back soft key) to cancel.

Editing contacts can be configured via the web user interface at the path **Directory->Local**.

Deleting Contacts

You can delete local contacts or conference contacts via the remote control or web user interface.

To delete local contact via the remote control:

1. Press  (Call soft key).
 2. Press ◀ or ▶ to select the **Directory** menu.
 3. Press ▲ or ▼ to select the desired local contact.
 4. Press  (Detail soft key).
 5. Press ▲ or ▼ to highlight the **Delete This Contact**, and then press .
- The display device prompts "Delete this contact?"
6. Press ▲ or ▼ to highlight **OK**.
 7. Press  to delete the local contact.

Deleting contacts can be configured via the web user interface at the path

Directory->Local.

Searching for Contacts

You can search local contacts or conference contacts via the remote control or web user interface.

To search contacts via the remote control:

1. Press  (Call soft key).
2. Press ◀ or ▶ to select the **Directory** menu.
3. Press ▲ or ▼ to select the searching box.

You can select the desired contact type from the pull-down list of the **All Contacts** first.

4. Enter a few or all characters of the contact name or numbers.

The contacts whose names or phone numbers match the characters entered will appear on the display device.

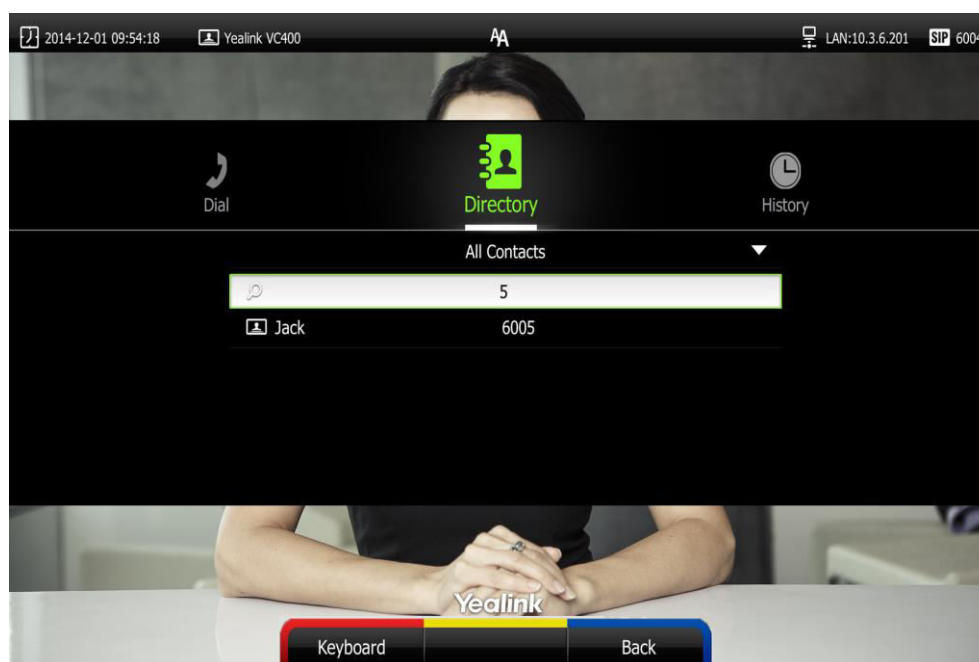

5. You can press ▲ or ▼ to select the desired contact, and then call or edit the contact.





Search Source List in Dialing

You can search for a contact from the desired lists when the phone is in the pre-dialing screen. The lists can be Local Directory, History and LDAP.

In the pre-dialing screen, when you enter a few characters, the system will search the matched contacts from the enabled search source lists, and display the result in the dialing screen.

If you want to match the LADP list, make sure LDAP is configured already. For more information about how to configure LDAP, contact your system administrator.

To configure search source list in dialing via the web user interface:

1. Click on **Directory->Setting**.
2. In the **Search Source List In Dialing** block, select the desired list from the **Disabled** column and click  .
The selected list appears in the **Enabled** column.
3. Repeat step 2 to add more lists to the **Enabled** column.
4. (Optional.) To remove a list from the **Enabled** column, select the desired list and then click  .
5. To adjust the display order of the enabled list, select the desired list, and click  or  .

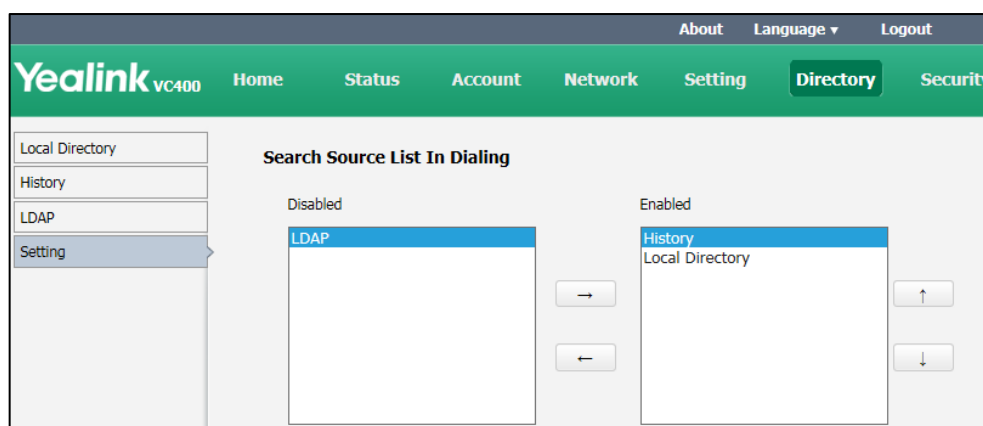

6. Click **Confirm** to accept the change.

Note

Search source list in dialing is only configurable via the web user interface.

To place a call via search source lists:

1. Press  (**Call** soft key).
2. Enter a few or all characters of the contact name or numbers.
The contacts whose names or phone numbers match the characters entered will appear on the display device.

3. Press ▲ or ▼ to select the desired contact, and then press  or  to call the contact.

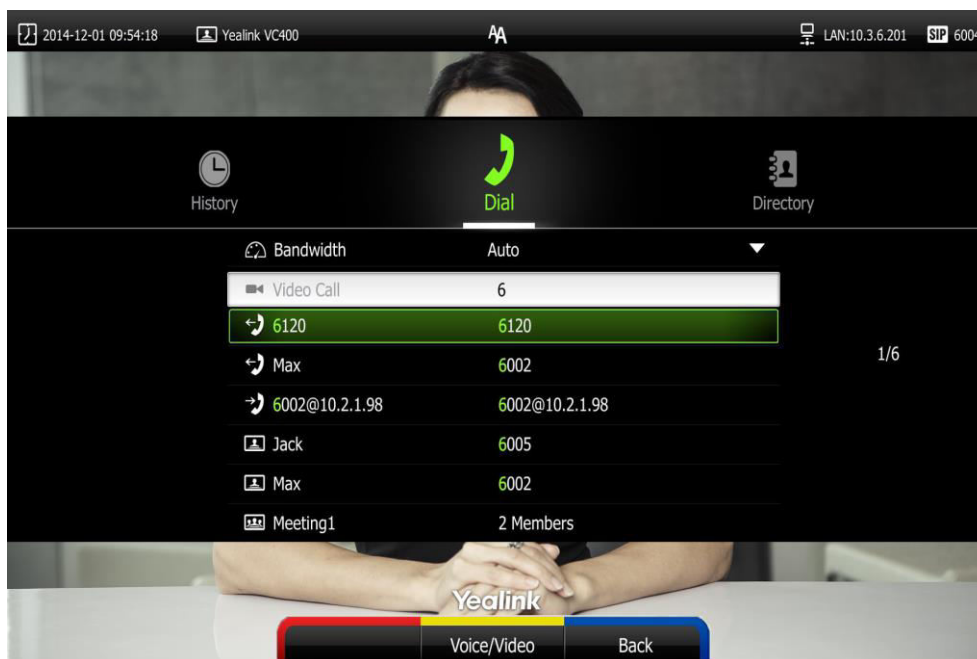

Importing/Exporting Contact Lists

You can import or export the contact list to share contacts between different systems or between system and application software (e.g., Outlook).

The VC400 video conferencing system only supports the XML and CSV format contact lists. You can only import or export the contact list via the web user interface.

To import an XML file of contact lists via the web user interface:

1. Click on **Directory**-> **Local Directory**.
2. Click **Import/Export**.
3. Click **Import**.

4. Click **Browse** to locate a contact list file (file format must be *.xml) from your local system.

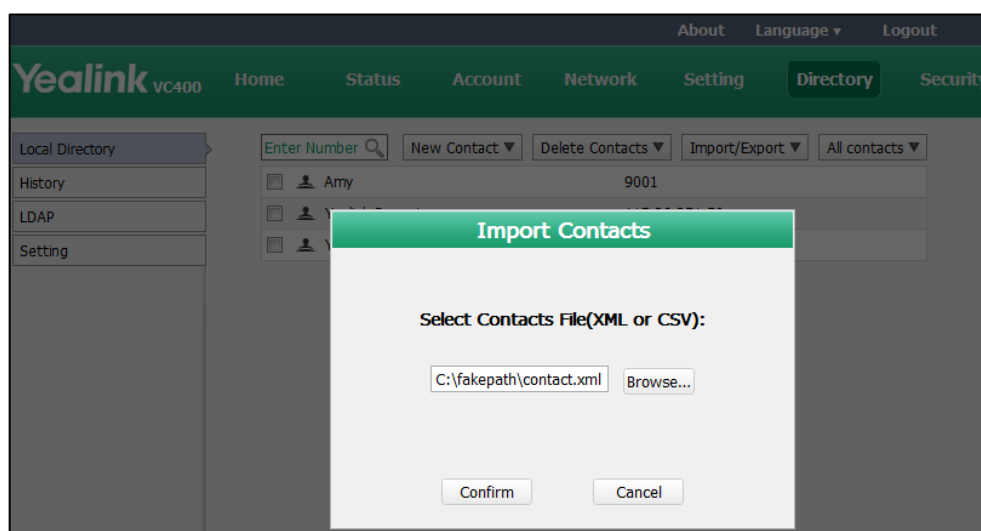

5. Click **Confirm** to import the contact list.
The web user interface prompts "The original contact will be covered, continue?".
6. Click **Confirm** to complete importing the contact list.
The web user interface prompts "Contacts imported successfully!".

To import a CSV file of contact lists via the web user interface:

1. Click on **Directory->Local Directory**.
2. Click **Import/Export**.
3. Click **Import**.
4. Click **Browse** to locate a contact list file (file format must be *.csv) from your local system.
5. Click **Confirm**.

The web user interface is shown as below:

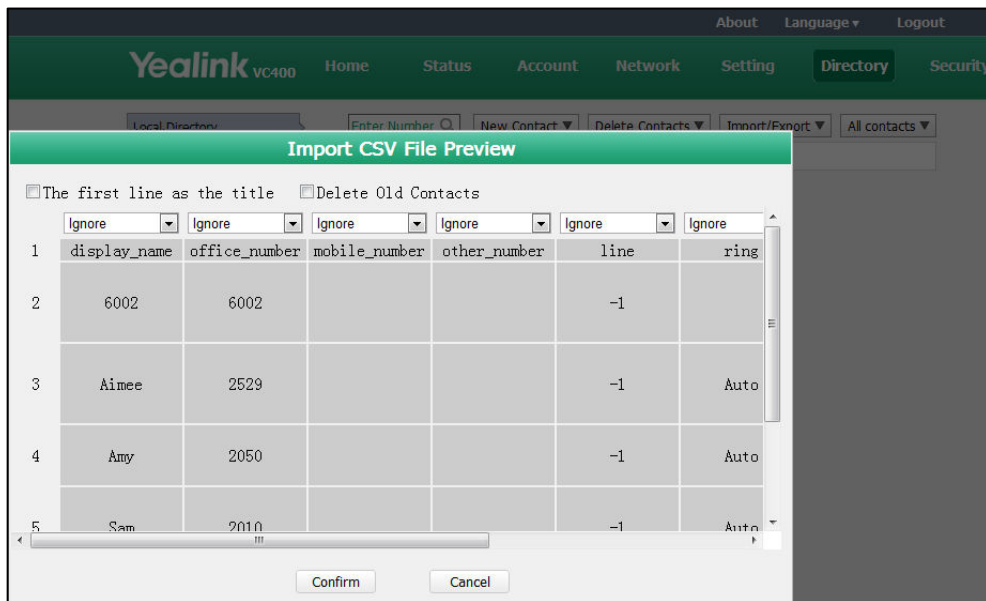

6. (Optional.) Check the **The first line as the title** checkbox.
It will prevent importing the title of the contact information which is located in the first line of the CSV file.
7. (Optional.) Check the **Delete Old Contacts** checkbox.
It will delete all existing contacts while importing the contact list.
8. Select the desired value from the pull-down list.
 - If **Ignore** is selected, this column will not be imported to the system.
 - If **Display Name** is selected, this column will be imported to the system as the contact's name.

- If **number1/2/3** is selected, this column will be imported to the system as the contact's number.

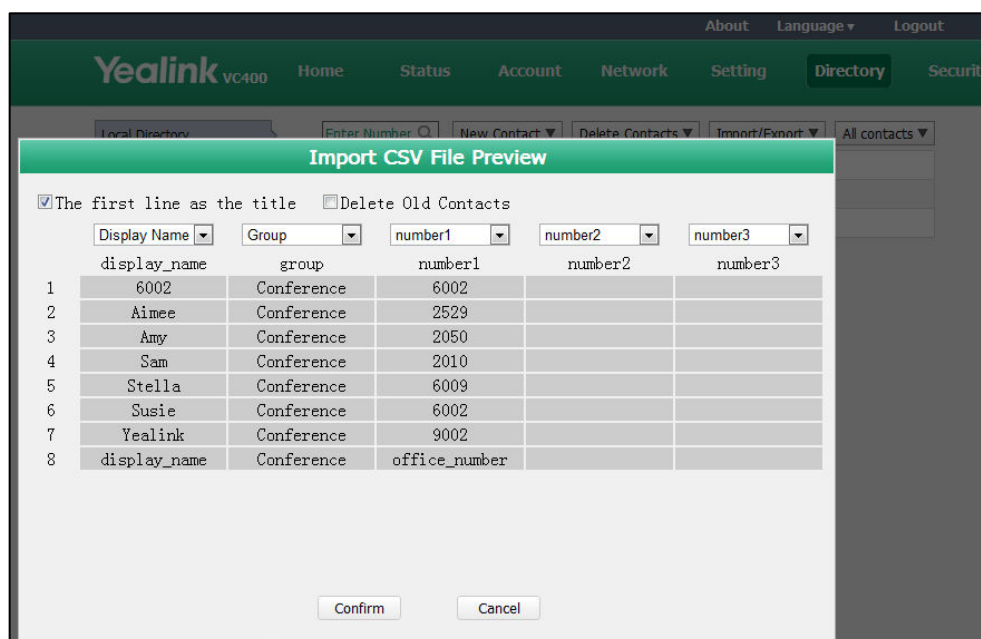

9. Click **Confirm** to complete importing the contact list.

The web user interface prompts "Contacts imported successfully!".

Note

The display name must be imported to the terminal. If not, the CSV file cannot be imported.

To export a contact list via the web user interface:

1. Click on **Directory->Local Directory**.
2. Click **Import/Export**.
3. Click **Export XML** or **Export CSV**.
4. The contact list is saved to your local system.

Call History Management

The VC400 video conferencing system maintains call history lists of All Calls, Missed Calls, Placed Calls and Received Calls. The system supports up to 400 history lists. You can view the call history, place a call or delete an entry from the call history list.

To save call history on the system, you need to enable the history record feature in advance. The history record feature is enabled by default, and you can configure it via the remote control or web user interface.

To configure the history record feature via the remote control:

1. Press  (**Menu** soft key) to enter main menu.

2. Press ◀ or ▶ to select the **Call Features** menu.
3. Press ▲ or ▼ to scroll to **History record**, and then press **OK** to enable or disable this feature.

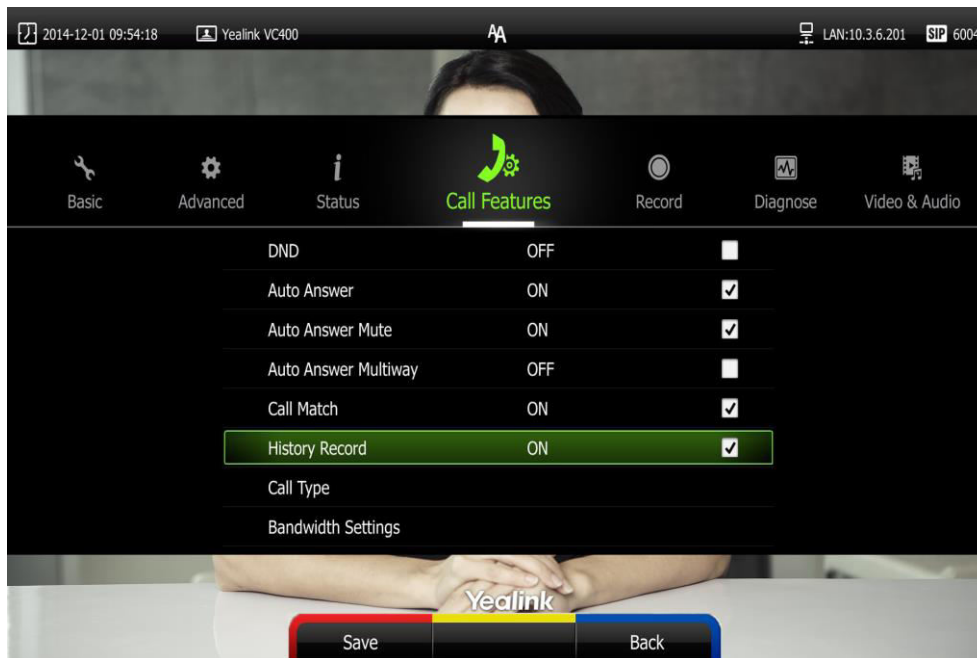

4. Press **Save** (Save soft key) to accept the change.



The history record feature can be configured via the web user interface at the path **Setting->Call Features->History Record**.

Viewing Call History

You can view call history via the remote control, VCP40 phone or web user interface.

To view call history via the remote control:

1. Press **Call** (Call soft key).
2. Press ◀ or ▶ to select the **History** menu.
The display device shows recent call history.
3. Press **OK** to open the pull-down list of **All Calls**.
4. Press ▲ or ▼ to select the desired call history list, and then press **OK**.
5. Press ▲ or ▼ to view the desired call history.

If the call history is more than one page, you can press  or  to turn pages.

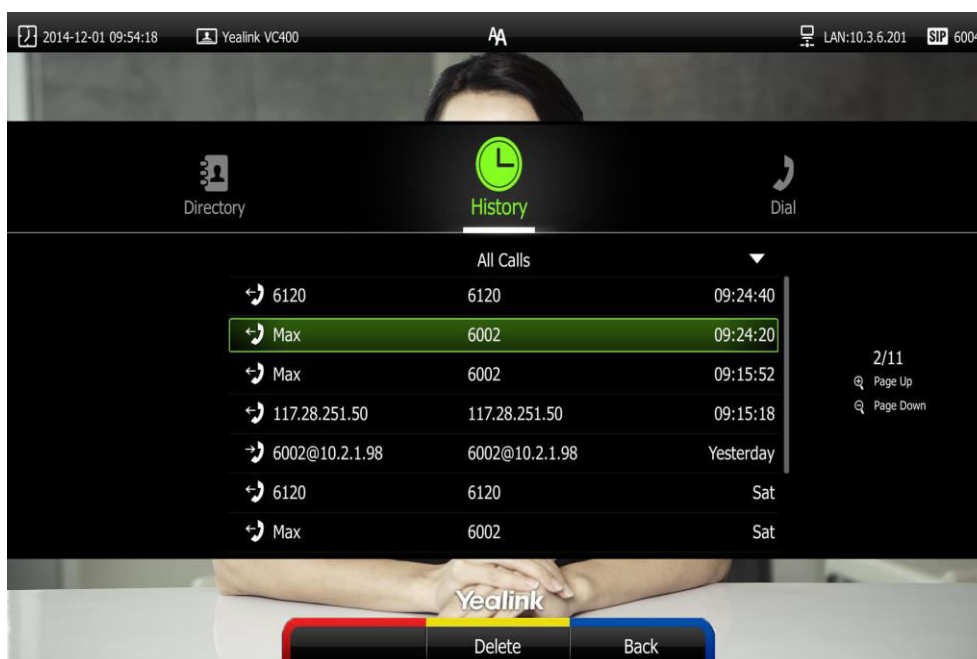





To view call history via the VCP40 phone:

1. Press the **History** soft key.

Recent call history is displayed on the LCD screen of the VCP40 phone.











2. Press  or  soft key to switch call history list.
3. Press  or  to view the desired call history.

Placing a Call from the Call History List

You can place a call from the call history list via the remote control, VCP40 phone or web user interface.

To place a call from the call history list via the remote control:

1. Press  (Call soft key).
2. Press  or  to select the **History** menu.
The display device shows recent call history.
3. Select the desired call history list from the pull-down list of **All Calls**, and then press .
4. Press  or  to select the desired call history.

If the call history is more than one page, you can press  or  to turn pages.







5. Press  or .

To place a call from the call history list via the VCP40 phone:

1. Press the **History** soft key.

Recent call history is displayed on the LCD screen of the VCP40 phone.









2. Press  or  soft key to switch call history list.
3. Press  or  to select the desired call history.
4. Press the **Send** soft key,  or .

Deleting an Entry from the Call History List

You can delete an entry from the call history list via the remote control or web user interface.

To delete an entry from the call history list via the remote control:

1. Press  (**Call** soft key).
2. Press  or  to select the **History** menu.
3. Press  or  to select the desired call history.

If the call history is more than one page, you can press  or  to turn pages.

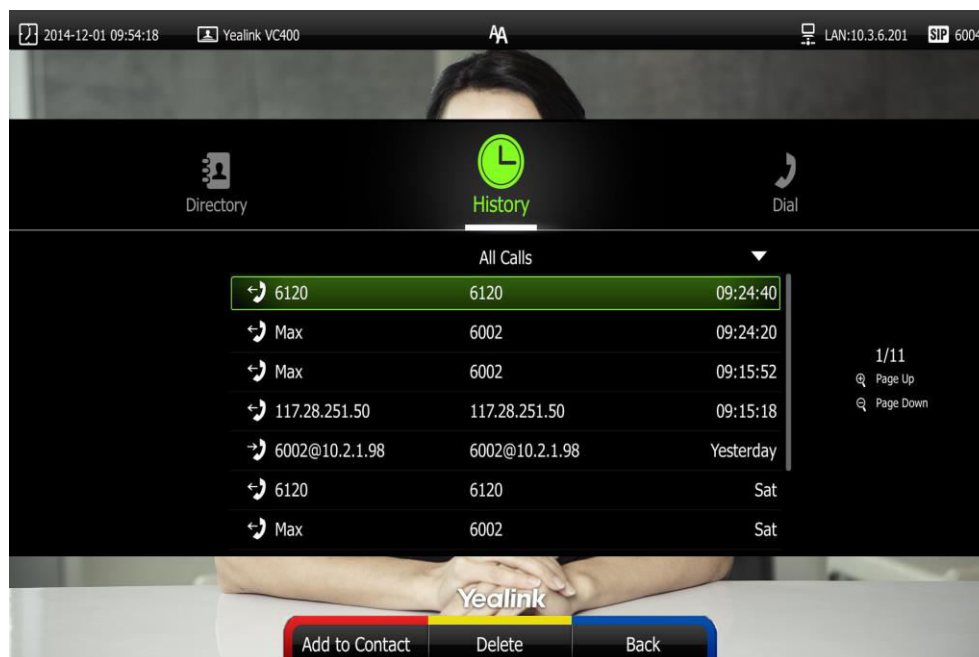

4. Press  (**Delete** soft key) to delete the entry.

To clear call history via the remote control:

1. Press  (**Call** soft key).
2. Press ◀ or ▶ to select the **History** menu.

The display device shows recent call history.

3. Press  (**Clear** soft key).

You can also select the call history list you want to clear from the pull-down list of **All Calls**, and then press  (**Clear** soft key) to clear the call history in the selected list.

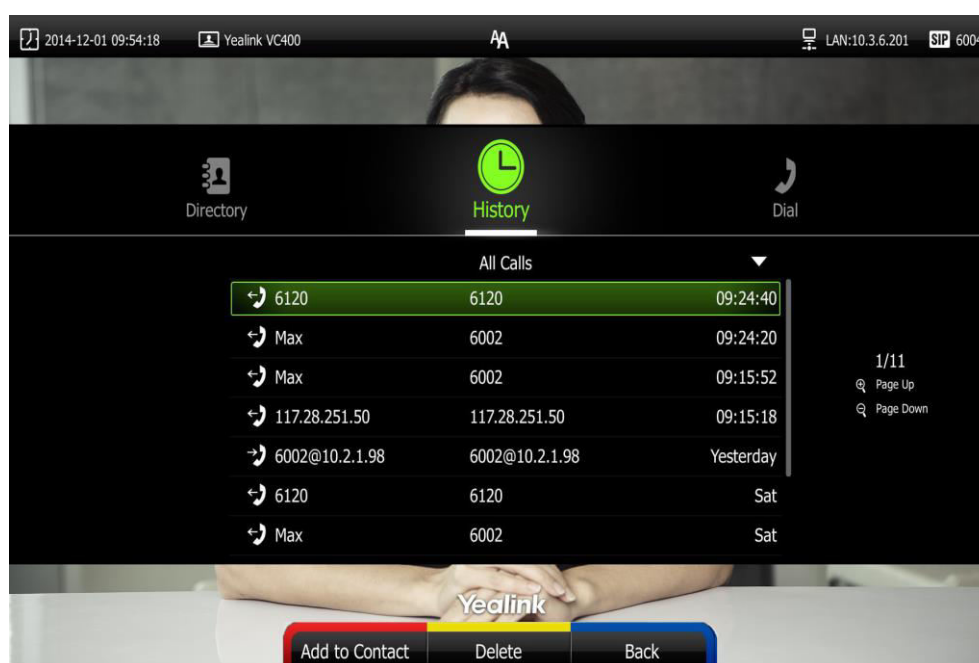

The display device prompts "Delete all records?".





5. Press ▲ or ▼ to select **OK**.
6. Press  to clear the call history.

Adding a Contact from the Call History List

1. Press  (**Call** soft key).
2. Press ◀ or ▶ to select the **History** menu.
The display device shows recent call history.
3. Press ▲ or ▼ to select the desired call history.

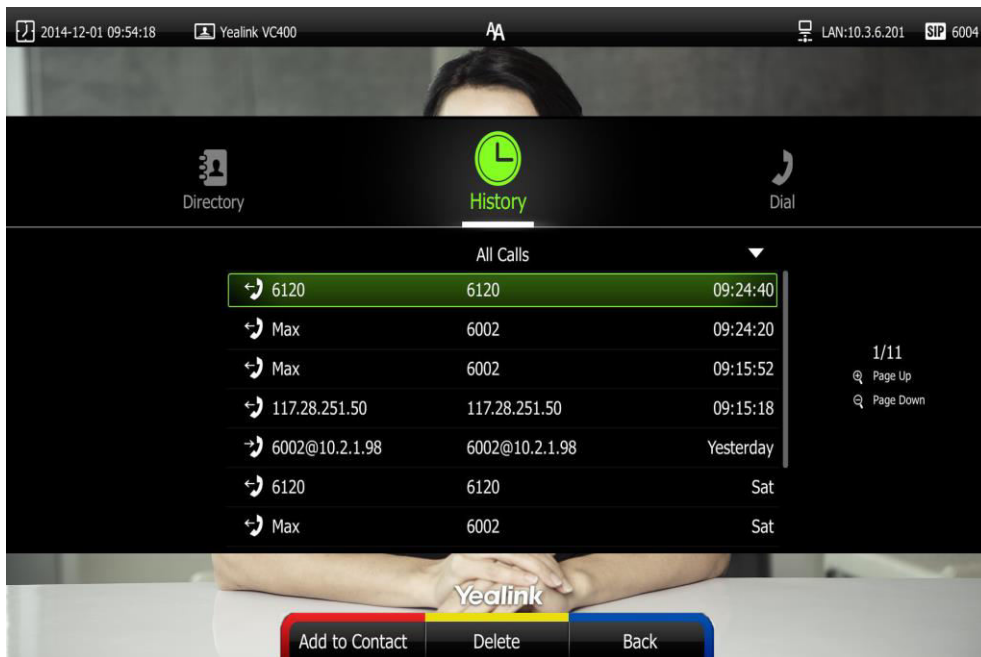
If the call history is more than one page, you can press  or  to turn pages.



- Press  (**Add to Contact** soft key).
Enter contact name in the **Name** field.
You can add more than one number for the contact. For more information, refer to [Adding Contacts](#) on page 43.
- Press  (**Save** soft key) to save the contact.



Call history management feature can be configured via the web user interface at the path **Directory->History**.

Call Type

The VC400 video conferencing system supports SIP and H.323 call types. You can configure which type to be used when the system is making calls. When the **Auto** call type is used, the system preferentially uses the H.323 protocol to place calls. If there is no available H.323 account on the system, the system will switch to the SIP protocol. You can also specify the desired protocol for the system to place calls via the remote control or web user interface.

Note Before configuring call type, ensure the remote system supports the call type too. For more information, contact your system administrator.

To configure the call type via the remote control:

- Press  (**Menu** soft key) to enter main menu.
- Press  or  to select the **Call Features** menu.

3. Press ▲ or ▼ to scroll to **Call Type**, and then press **OK**.

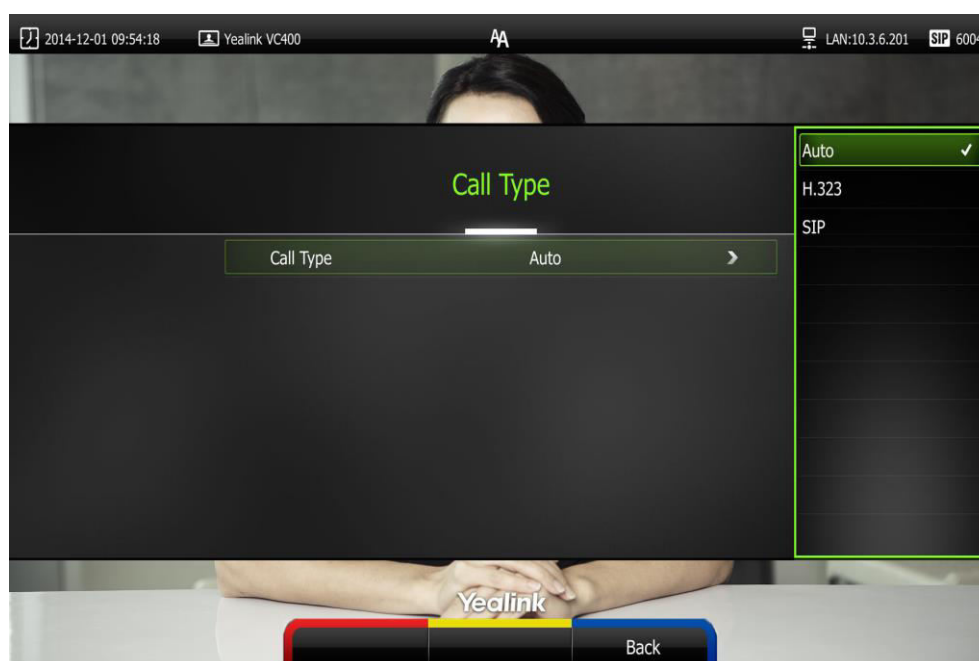

4. Select desired type or **Auto** from the pull-down list of **Call Type**.
5. Press  (**Save** soft key) to accept the change.

Call type can be configured via the web user interface at the path **Setting->Call Features-> Call Type**.

Bandwidth Settings

By default, the system automatically detects the available bandwidth and uses this connection speed.

You can specify the uplink and downlink bandwidths for the system to achieve the best result. The uplink bandwidth refers to the max transmitting bandwidth. The downlink bandwidth refers to the max receiving bandwidth.

Available bandwidths for the system are: Auto, 256kb/s, 384kb/s, 512 kb/s, 640 kb/s, 768 kb/s, 1024kb/s, 1280kb/s, 1500kb/s, 2000kb/s, 3000kb/s, 4000kb/s, 5000kb/s, 6000kb/s. You can configure which bandwidth is to be used when in the dialing screen. The optional maximum bandwidth in dialing screen is the uplink bandwidth.

You can configure the uplink and downlink bandwidth of the system via the remote control or web user interface.

Note

The actual resolution depends on the performance of the remote system, and is affected by the quality of the communication channel.

To configure the uplink and downlink bandwidth via the remote control:

1. Press  (**Menu** soft key) to enter main menu.

2. Press ◀ or ▶ to select the **Call Features** menu.
3. Press ▲ or ▼ to scroll to **Bandwidth Settings**, and then press **OK**.
4. Select desired bandwidth from the pull-down list of **Uplink Bandwidth**.
If **Auto** is selected, the system will select the appropriate bandwidth automatically.
5. Select desired bandwidth from the pull-down list of **Downlink Bandwidth**.
If **Auto** is selected, the system will select the appropriate bandwidth automatically.

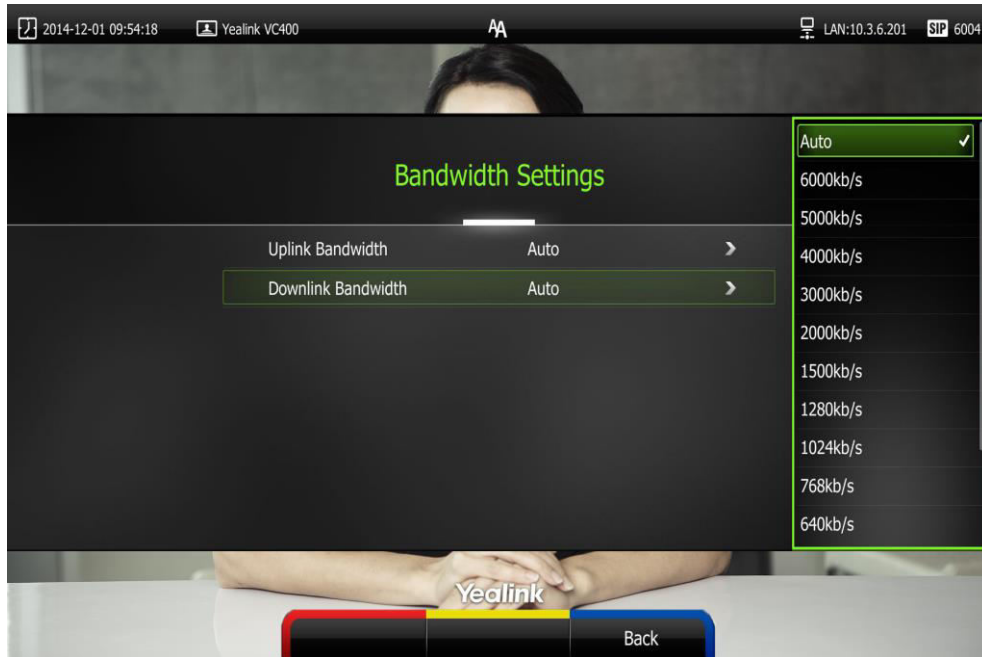

6. Press **Save** (Save soft key) to accept the change.

Bandwidth can be configured via the web user interface at the path **Setting->Call Features->Uplink Bandwidth/Downlink Bandwidth**.

Audio Setting

Audio Output Device



By default, the system automatically selects the available audio output devices. If the VCP40 phone is connected to the Audio In port on the VC400 codec, the system will use the VCP40 phone as the audio output device.

If many available audio output devices have been connected to the system, the system will select the audio output device with higher priority, and the priority is: VCP40 Phone>Line Output>HDMI. You can also specify which audio output device is to be used according to the current environment. The system supports the following audio devices:

- **Auto** (audio output device with higher priority is selected automatically)
- **HDMI** (built-in speakerphone of the display device)

- **Line Output** (speakerphone connected to the Line Out port on the VC400 codec)
- **VCS Phone** (VCP40 phone)
- **Line out+HDMI** (speakerphone connected to the Line Out port on the VC400 codec+ built-in speakerphone of the display device)

To configure the audio output device via the remote control:

1. Press  (**Menu** soft key) to enter main menu.
2. Press ◀ or ▶ to select the **Video & Audio** menu.
3. Press ▲ or ▼ to scroll to **Audio Settings**, and then press .
4. Select desired audio output device from the pull-down list of **Audio Output**.

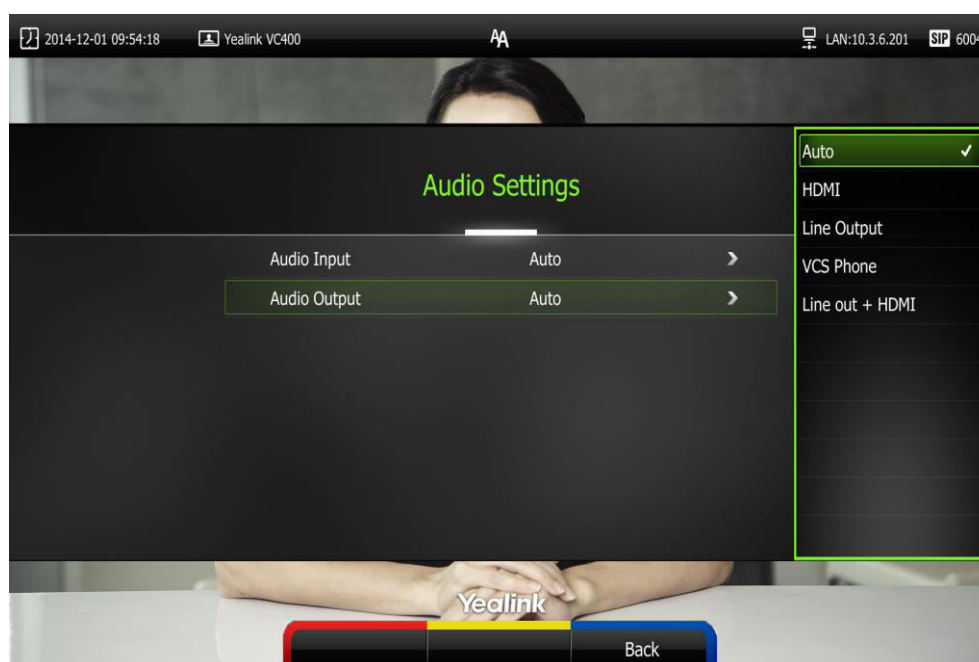

5. Press  (**Save** soft key) to accept the change.







Audio output device can be configured via the web user interface at the path **Setting->Video & Audio->Audio Output**.

Audio Input Device

By default, Auto is selected as the audio input device. All available audio input devices can be used during a call. If the VCS phone is selected as the audio input device and the Audio In port on the VC400 codec is connected to the VCP40 phone, the system will use the VCP40 phone as audio input device. You can configure which audio input device is to be used according to the current environment. The system supports the following audio input devices:

- **Auto** (use all available audio input devices)
- **Line Input** (microphone connected to the Line In port on the VC400 codec)
- **VCS Phone** (VCP40 phone)

To configure the audio output device via the remote control:

1. Press  (**Menu** soft key) to enter main menu.
2. Press  or  to select the **Video & Audio** menu.
3. Press  or  to scroll to **Audio Setting**, and then press .
4. Select desired audio output device from the pull-down list of **Audio Input**.

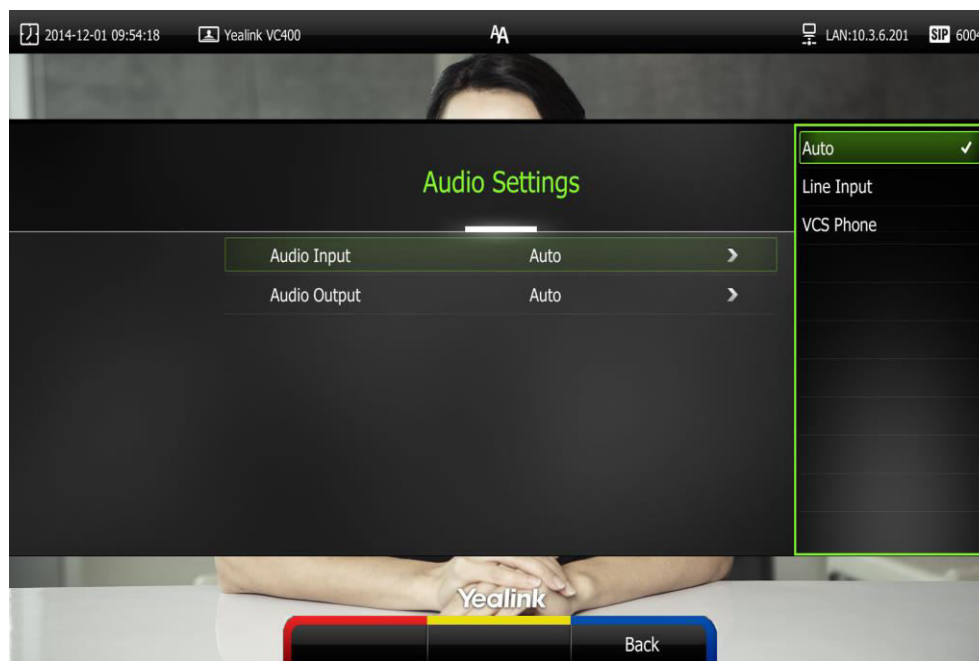

6. Press  (**Save** soft key) to accept the change.

Audio input device can be configured via the web user interface at the path **Setting->Video & Audio->Audio Input**.

Far-end Camera Control

Local video is shown on the remote display device during a call. You can enable the far-end camera control feature allowing the far-end to control the local camera angles and focus and show local video better on the remote display device. You can also configure whether to allow the remote system to use or save the presets of the local camera.

You can configure the far-end camera control feature via the remote control or web user interface.

Note

If the remote system enables the far-end camera control feature, you can control the remote camera. For more information, refer to [Controlling the Camera](#) on page 79.

To configure Far-end Camera Control via the remote control:

1. Press  (**Menu** soft key) to enter main menu.

2. Press ◀ or ▶ to select the **Video & Audio** menu.
3. Press ▲ or ▼ to scroll to **Far-end Camera Control**, and then press **OK**.
4. Press ▲ or ▼ to scroll to **Far Control of Near Camera**, and then press **OK** to enable or disable this feature.
5. Press ▲ or ▼ to scroll to **Far Set of Near Camera Presets**, and then press **OK** to enable or disable this feature.

If you enable this feature, when the remote system completes adjusting local camera, it can save the presets of the local camera.

6. Press ▲ or ▼ to scroll to **Far Move to Near Camera Presets**, and then press **OK**.
If you enable this feature, the remote system can use the saved presets of the local camera during a call.

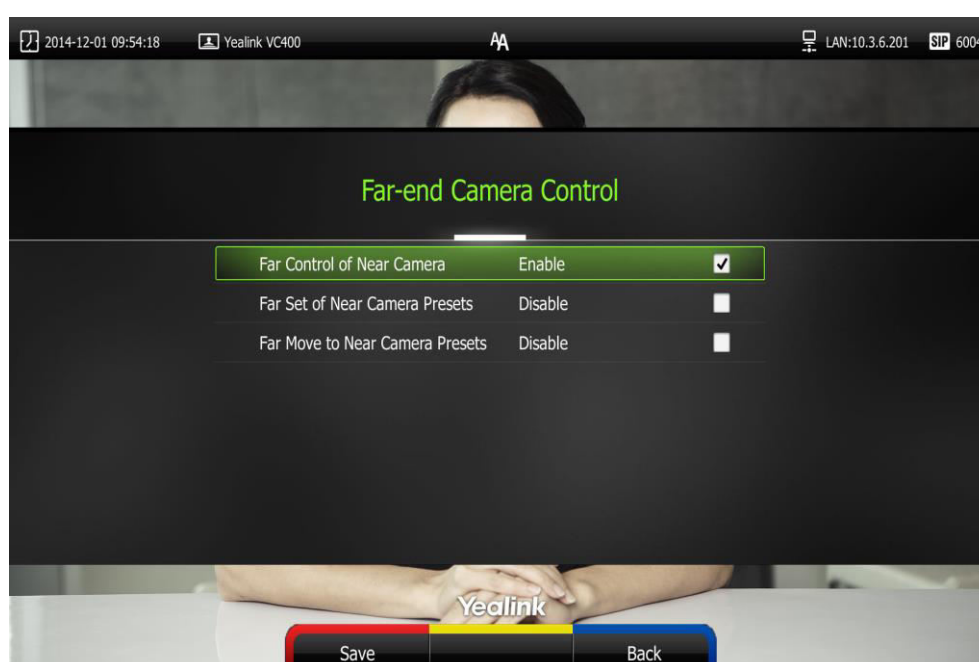

7. Press  (**Save** soft key) to accept the change.

Far-end Camera Control can be configured via the web user interface at the path **Setting->Video & Audio-> Far Control Near Camera/ Far Set of Camera Presets/ Far Move to Camera Presets**.

Using the VC400 Video Conferencing System

The VC400 video conferencing system can be used to place calls, answer calls, or conduct a conference call. You can switch layout, record videos or capture screenshots during a call.

This chapter provides basic operating instructions for the VC400 video conferencing system. Topics include:

- [Placing Calls](#)
- [Answering or Rejecting Calls](#)
- [Call Management](#)
- [Ending Calls](#)

If you require additional information or assistance to help you use your new phone, contact your system administrator.

Placing Calls

You can place a call in three ways using your VC400 video conferencing system:

- Using the remote control
- Using the VCP40 phone
- Via the web user interface

The VC400 video conferencing system supports two call types:

- Voice Call
- Video Call

When you place a call, you can select the desired call type and bandwidth.

Note

The system supports placing calls using contact numbers, SIP URI, IP address, H. 323 account or extension. SIP URI and IP addresses can be up to 32 characters. For example: SIP URI:2210@sip.com, IP: 192.168.1.15.
For more information, contact your system administrator.

You can search and dial a contact from the call history or local directory. For more information, refer to [Local Directory](#) on page 42 and [Call History Management](#) on page 54.

If the system fails to call, you can troubleshoot the problems according to the following prompts:



Prompts	Description
Call Failed Busy here	The remote system rejects the incoming call.
Network disconnected	Local network is disconnected.
Call Failed No Response	Remote system network anomaly or it is powered off.
Maximum number of sessions reached	The system has reached maximum sessions.

During a call, the call duration, plus the video of remote and local system are displayed on the display device.



Placing a Call Using the Remote Control

To place a call using the remote control:

1. Press  (Call soft key),  or any numeric key to enter the dialing screen.
You can select the desired bandwidth from the pull-down list of **Bandwidth** before calling.
2. Enter the desired number using the keypad or the on-screen keyboard.
You can also select the desired contact from the recent call history.

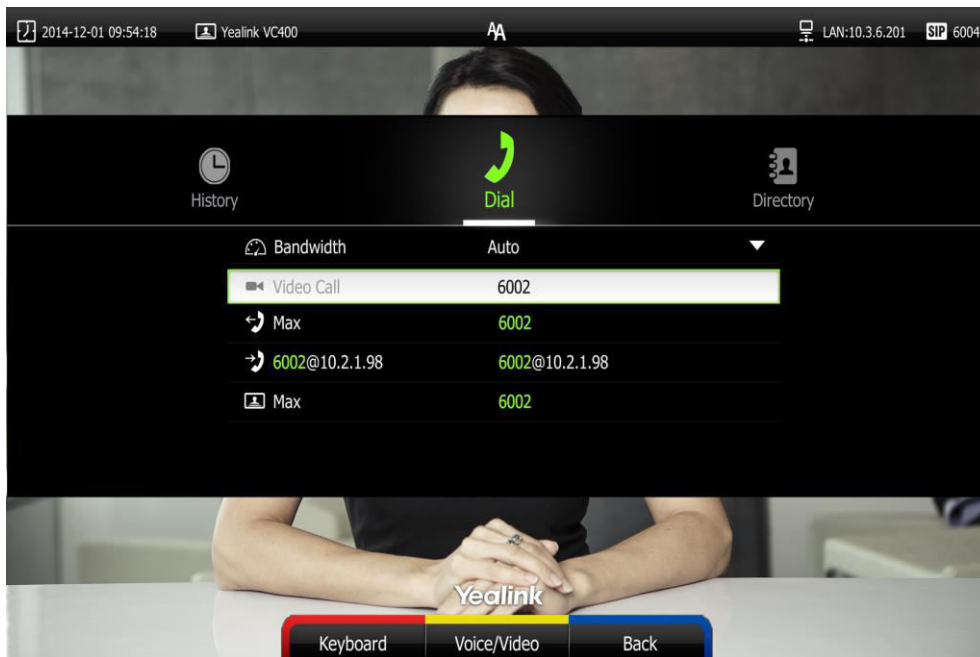

3. Press  (Voice/Video soft key) to switch call type.



4. Press  or .

Placing a Call Using the VCP40 Phone

To place a call using the VCP40 phone:

1. Enter the desired number using the keypad.
2. Press ,  or the **Send** soft key.

Placing a Call via the Web User Interface





To place a call via the web user interface:

1. Log into the web user interface.
2. Click **Home**.
3. Enter the desired number in the **Enter Number** field.
4. (Optional.) Select the desired bandwidth from the pull-down list of **Auto**.
5. Click **Video Call** or **Voice Call**.



Placing Multiple Calls

The VC400 video conferencing system can support up to 5 parties (4 video calls and 1 voice call, including the conference initiator) in a conference call. You can use the remote control, VCP40 phone or web user interface to place multiple calls.

To place a multiple call via the remote control:



1. Place a call to the first party.
2. When the first party answers the call, press  (**More** soft key) to open **More** window.
3. Press ▲ or ▼ to scroll to **New Call**, and then press  to place a new call.
4. Enter the number of the second party, and then press  or  .
When the second party answers the call, you have created a three-way conference.
5. Repeat the steps 2 to 4 to invite more parties to join the conference.
When the fourth party answers the call, you have created a five-way conference call.

Note

You can press  or  to enter the pre-dialing screen during a call.

When you try to invite a new party during the five-way conference, the system will prompt "Maximum number of sessions reached!"

To place a multiple call via the VCP40 phone:

1. Enter the desired number using the keypad.
2. When the first party answers the call, press **New Call** soft key to place a new call.
3. Enter the number of the second party, and then press ,  or the **Send** soft key.
When the second party answers the call, you have created a three-way conference
4. Repeat the steps 2 to 3 to invite more parties to join the conference.
When the fourth party answers the call, you have created a five -way conference.

To place a multiple call via the web user interface:

1. Log into the web user interface.
2. Click **Home**.
3. Enter the number of the first party in the **Enter Number** field, and then click **Video Call** or **Voice Call**.
When the first party answers the call, the call is established.
4. Enter the number of the second party in the **Enter Number** field, and then click **Video Call** or **Voice Call**.
When the second party answers the call, you have created a three-way conference.
5. Enter the number of the third party in the **Enter Number** field, and then click **Video Call** or **Voice Call**.
When the third party answers the call, you have created a four-way conference.

- Enter the number of the third party in the **Enter Number** field, and then click **Video Call** or **Voice Call**.

When the fourth party answers the call, you have created a five-way conference.

Answering or Rejecting Calls





When the system is receiving a call, you can answer or reject the call in the following ways:

- Using the remote control
- Using the VCP40 phone

If the system receives multiple calls, a conference call will be established.



To answer a call:

Do one of the following:

- Press  or  on the remote control.
- Press ,  or the **Answer** soft key on the VCP40 phone.

To reject a call:

Do one of the following:

- Press  or select **Reject** first, and then press  on the remote control.
- Press  or the **Reject** soft key on the VCP40 phone.

Auto Answer







You can enable the auto answer feature for the system to automatically answer the first incoming call.

You can also enable the auto answer mute feature for the system to turn off the microphone when an incoming call is answered automatically. The auto answer mute feature can be enabled only when the auto answer feature is enabled.

You can enable the auto answer multiway feature for the system to answer a new incoming call automatically during an active call. The auto answer multiway feature can be enabled only when the auto waiting feature is enabled.

Auto answer can be configured via the remote control or web user interface.

To configure auto answer via the remote control:

- Press  (**Menu** soft key) to enter main menu.
- Press  or  to select the **Call Features** menu.
- Press  or  to scroll to **Auto Answer**, and then press  to enable or disable this

feature.

4. Press ▲ or ▼ to scroll to **Auto Answer Mute**, and then press  to enable or disable this feature.

If you disable this feature, the system will disable the auto answer mute feature.

5. Press ▲ or ▼ to scroll to **Auto Answer Multiway**, and then press  to enable or disable this feature.

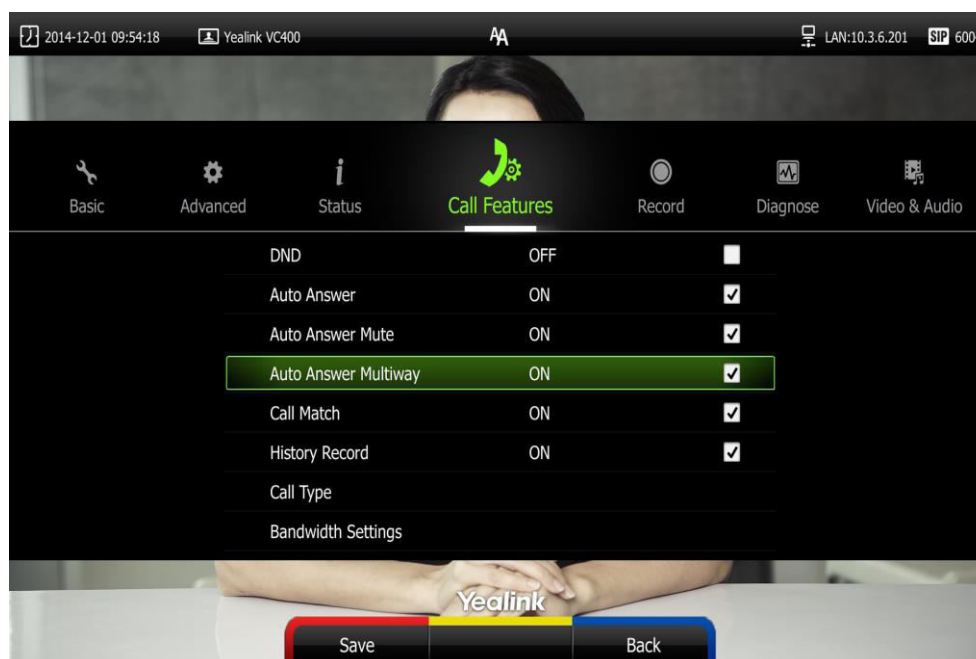

6. Press  (**Save** soft key) to accept the change.

If the auto answer feature is enabled, the **AA** icon will appear on the status bar of the display device. The  icon will appear on the LCD screen of the VCP40 Phone.

Auto answer can be configured via the web user interface at the path **Setting-> Call Features->Auto Answer/Auto Answer Mute/Auto Answer Multiway**.

Do Not Disturb (DND)

You can use DND to reject incoming calls automatically on the system. Callers will receive a busy message.

You can enable/disable DND for the system via the remote control, VCP40 phone or web user interface. You can also enable DND for the system to reject incoming call automatically during an active call.



To enable the DND mode via the remote control:

1. Press  (**Menu** soft key) to enter main menu.
2. Press ◀ or ▶ to select the **Call Features** menu.

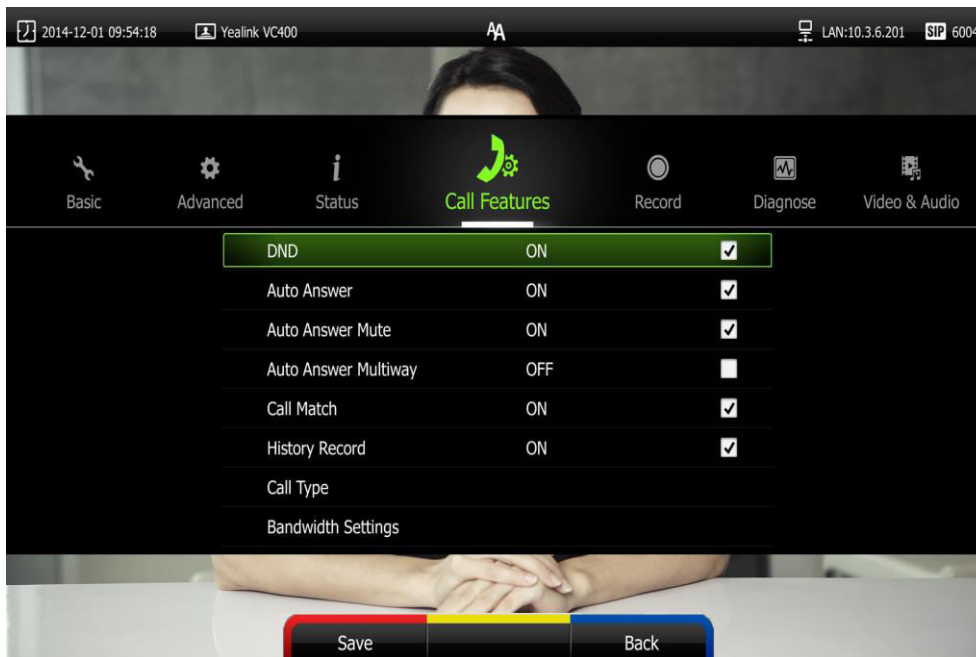
3. Press ▲ or ▼ to scroll to **DND**, and then press  to enable this feature.



4. Press  (**Save** soft key) to accept the change.

The  icon will appear on the status bar of display device, and “DND ON!” will be prompted at intervals. The  icon will appear on the LCD screen of the VCP40 phone.

The system will reject all incoming calls automatically, and the icon and numbers of missed calls are displayed on the status bar of the display device. If the system places a call, after the call is established, the DND mode will be disabled automatically.

When VCP40 phone is idle, you can also press the **DND** soft key to enable or disable this feature.



DND can be configured via the web user interface at the path **Setting->Call Features->DND**.



DND during an active call

You can use the DND mode to reject incoming calls automatically during an active call.

You can enable/disable the DND mode for the system via the remote control, VCP40 phone or web user interface. The DND mode will be disabled after the call.

To enable the DND mode during an active call via the remote control:

1. Press  (**More** soft key) during an active call.
2. Press ▲ or ▼ to scroll to **DND**, and then press  to enable this feature.

The  icon will appear on the status bar of display device, the  icon will appear on the LCD screen of the VCP40 phone.

3. Press  (**Back** soft key) to return.





You can also press the **DND** soft key on the VCP40 phone to enable or disable DND feature during an active all.





DND during an active all feature can be configured via the web user interface at the path **Home->DND**.

Ending Calls

During a two-way call, do one of the following to end the call.

- Press  on the remote control.
- Press  or the **End Call** soft key on the VCP40 phone.
- Click **Hang Up All** button on the web user interface.
The interface prompts "Hang up?"
Click **Confirm** to end the call.

During a multi-way call, do one of the following to end the call.



- Press  on the remote control.
The display device prompts "End all active calls?"
Select **Yes**, and then press .
- Press  or the **End Call** soft key on the VCP40 phone.
The LCD screen of the VCP40 phone prompts "End All Active Calls?"
Press  or the **Yes** sort key to end all calls.
- Click **Hang Up All** button on the web user interface.

The interface prompts "Hang up?"



Click **Confirm** to end the call.

During a multi-way call, you can remove any party via the remote control or web user interface.

To remove any party via the remote control:

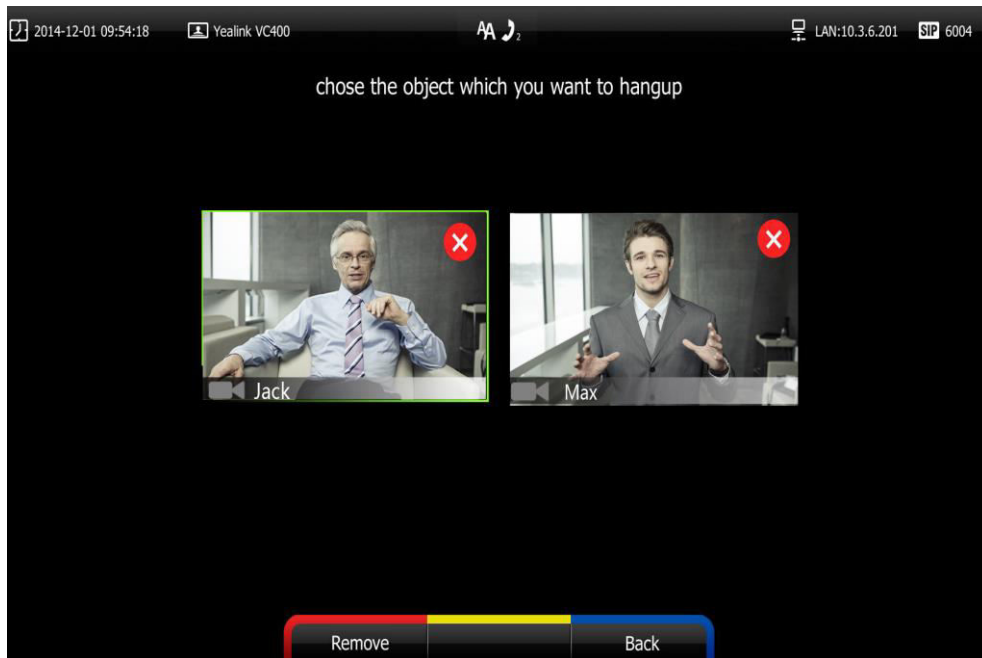
1. Press  (**More** soft key) during a multi-way call.
2. Press ▲ or ▼ to scroll to **Remove**, and then press .



3. Select the party you want to remove, and then press .
4. Press  (**Remove** soft key).

To remove any party from a multi-way call via the web user interface, at the path **Home** (Hover your cursor over of the number of remote system, and then click ).

Call Management



You can enable mute mode, record video, control the video and change video layout during an active call.

Call Mute

You can enable mute mode to mute the microphone of the active audio device during an active call, and then the other party cannot hear you.

To mute a call:

Do one of the following:

- Press  on the remote control.
The  icon will appear on the local video.
- Press  on the VCP40 phone.
The LED indicators on the VCP40 phone will illuminate solid red, the LCD screen is shown as below:



- Login to the web user interface, check the **Mute** checkbox.
The  icon will appear on the local video of the web user interface.

Call Statistics

If voice quality is poor during a call, you can enter the Call Statistics screen to view the current status of the call to find out why.

Codec, bandwidth, total packet lost and other parameters about presentation are included in the call statistics. For example, when a delay occurs or the video has a 'mosaic' look, you can view the total packet loss to check whether the packet has been lost.

Call statistics can be configured via the remote control or web user interface.

To view call statistics via the remote control:

1. Press  (**More** soft key) during an active call.

- Press ▲ or ▼ to scroll to **Call Statistics**, and then press  to enter the **Call Statistics** screen.

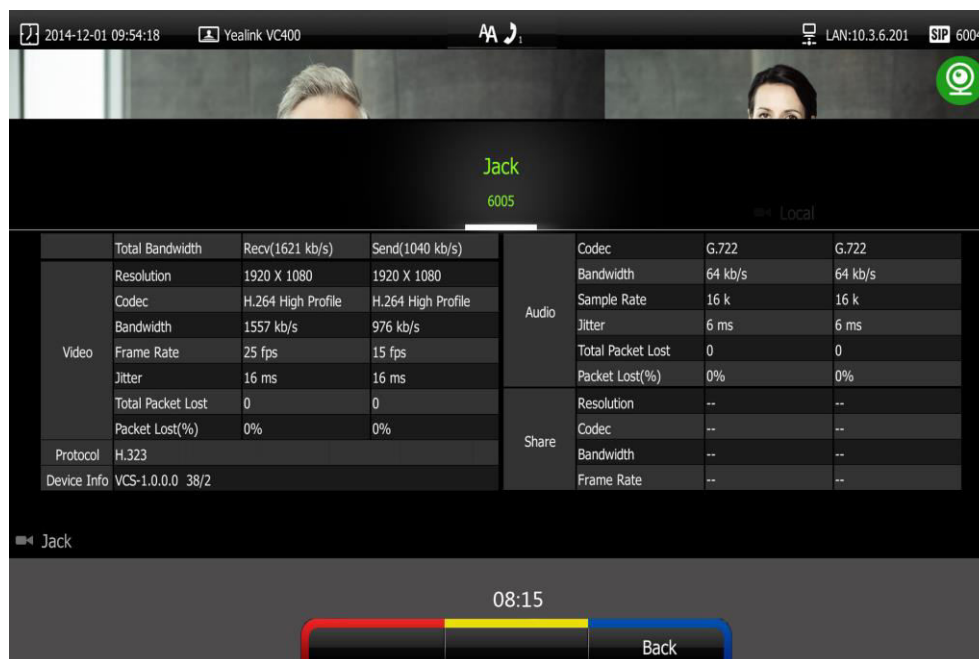

- Press  (**More** soft key) to return.

To view call statistics via the web user interface, at the path **Home** (Hover your cursor over the registered account, and then click ).

Presentation



The system supports video and documents presentation. During a call, if a PC is connected to the VC400 codec, the system will start presentation automatically. Both local and remote display devices will share presentations.

You can also start/end presentation during a call via the remote control or VCP40 phone (ensure a PC is connected to the VC400 codec). If you disconnect the PC, the presentation will end automatically.

Only one presentation can be shared at a time. A presentation started later will replace the previous presentation.

To start/end presentation during a call:

Do one of the following:

- Press  (**Presentation** soft key) on the remote control.
Press again to end the presentation.
- Press  on the VCP40 phone.
Press again to end the presentation.

To start/end presentation during a call by changing the video input source:

1. Press  .



The display device shows **Camera, Camera and PC and PC** input sources.

- If you select **Camera and PC** or **PC**, the display device will share presentation.
- If you select **Camera**, the display device will end share presentation.

Note For more information on changing video input source, refer to [Changing the Video Input Source](#) on page 81.

Changing the Video Layout

During a conference call, local and remote video images are displayed on the display device. You can change the screen layout. The system supports three screen layouts.

- One big, other small (): The selected video image is shown in a big size format, the other video images along the right side of the screen are shown in small sizes.
- Full screen (): The selected video image is shown in full size.
- Same size (): All video images are shown in the same size.

If one display device is connected to the VC400 codec (single screen), the default screen layout during a call is:

- If there is one active call and local system does not start the presentation, the remote video image is shown in big size, the local video image along the right side of the screen is shown in small size.

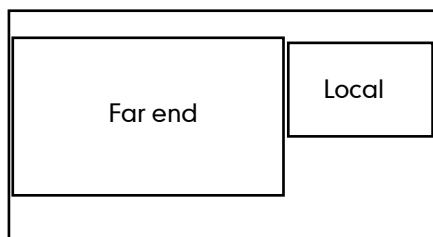

- If there are multiple active calls and the local system does not start the presentation, both local and remote video image are shown in the same size.

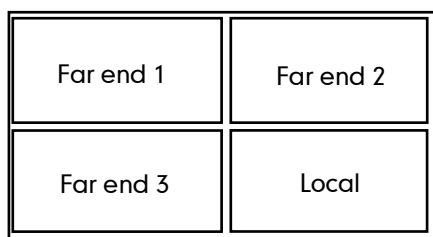

- If the local system is sharing a presentation, presentation will be shown in big size, and other video images will be shown in small sizes.

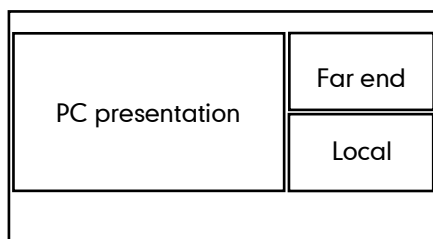

If two display devices are connected to the VC400 codec (dual screen), the default screen layout during a call is:

- If there is one active call and local system does not start the presentation.
The main display device shows the remote video image.
The second display device shows the local video image.

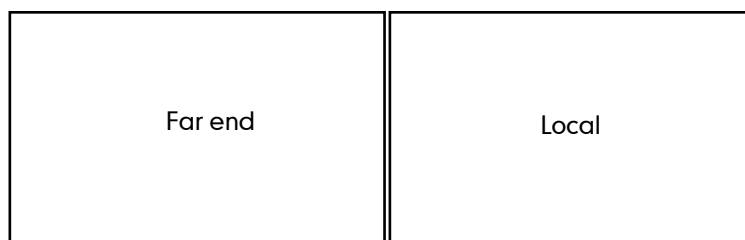

Main display device

Second display device

- If there are multiple active calls and local system does not start the presentation.
The main display device shows local and remote video images in the same size.
The second display device shows the local video image in full size.

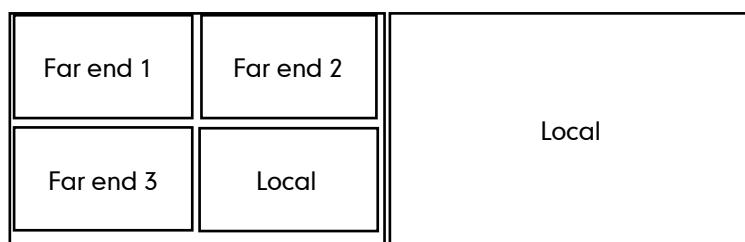

Main display device

Second display device

- If there is one active call and local system is sharing the presentation.

In the main display device, the remote video image is shown in big size, the local video image along the right side of the screen is shown in small size.

In the second display device, the presentation is shown in full size.



Main display device

Second display device

- If there are multiple active calls and local system is sharing the presentation.

In the main display device, both the local and remote video images are shown in same size. In the second display device, the presentation is shown in full size.

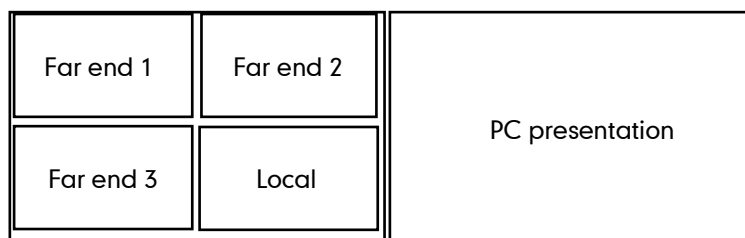

Main display device

Second display device

To change screen layout via the remote control:

1. Press  (**Layout** soft key) during an active call.

The display device shows all video thumbnails and three layout soft keys.

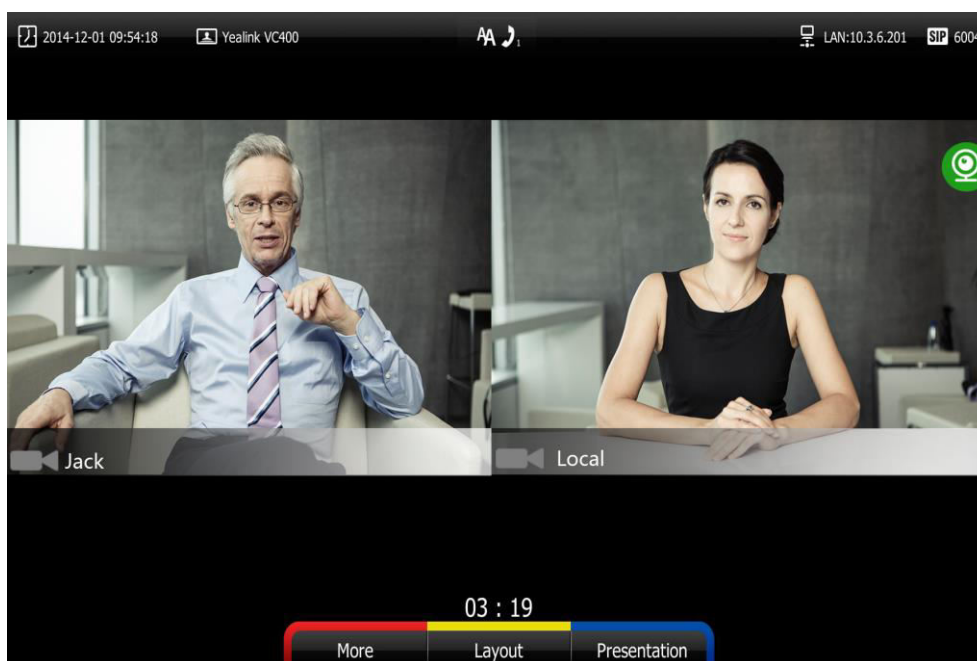

2. Press ◀ or ▶ to select a video.
3. Press the desired layout soft key.

The selected video will be shown in the selected layout.

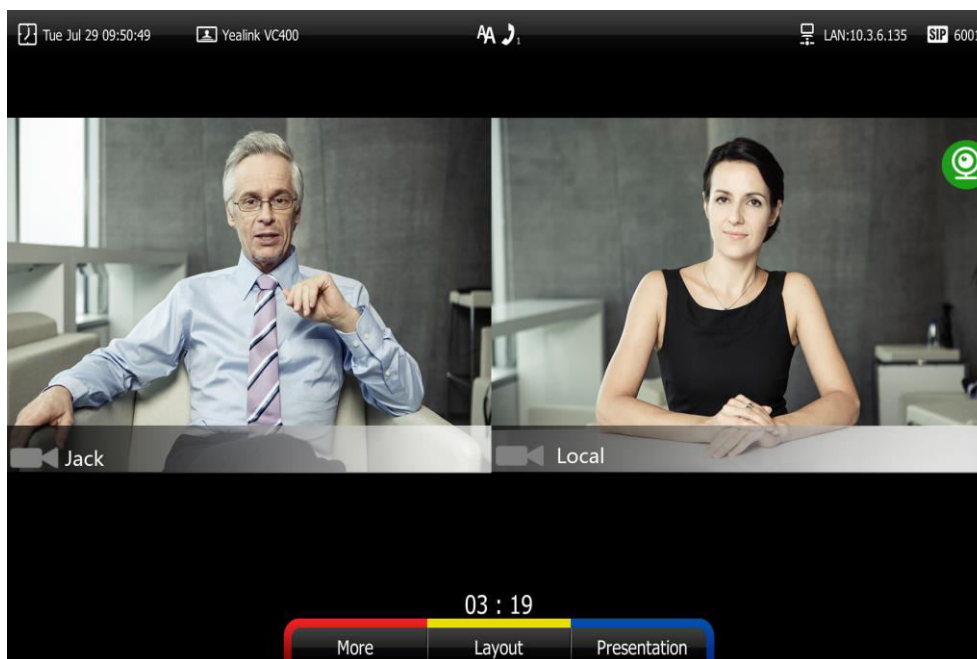

Controlling the Camera

Before placing a video call, you need to be familiar with how to adjust the angle and focus of the camera. After any adjustment, you can long press number keys 0-9 to save the new position of the camera.

Up to 10 presets can be saved to the system. You can also adjust the angle and focus of the camera and save the preset to a number key during the video call via the remote control or web user interface. This means that you can adjust the camera to the preset position by pressing a saved key.

If the remote system enables the **Far Set of Near Camera Presets** feature, you can control the remote camera during the video call via the remote control.

Note

Avoid physically adjusting the camera to prevent damaging it. Always use the remote control to control the camera.

To control the camera when the system is idle via the remote control:

1. Press ▲ or ▼ to adjust the angle of the camera.

The display device shows the current angle of the camera.

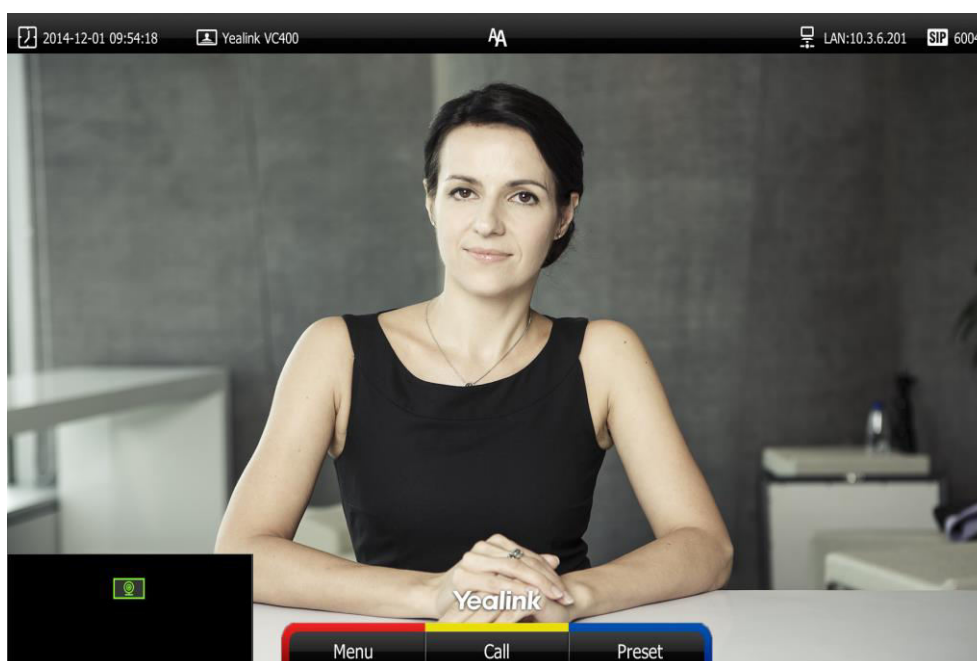

2. Long press or to adjust the focus of the camera.
The display device shows the focus of the camera.

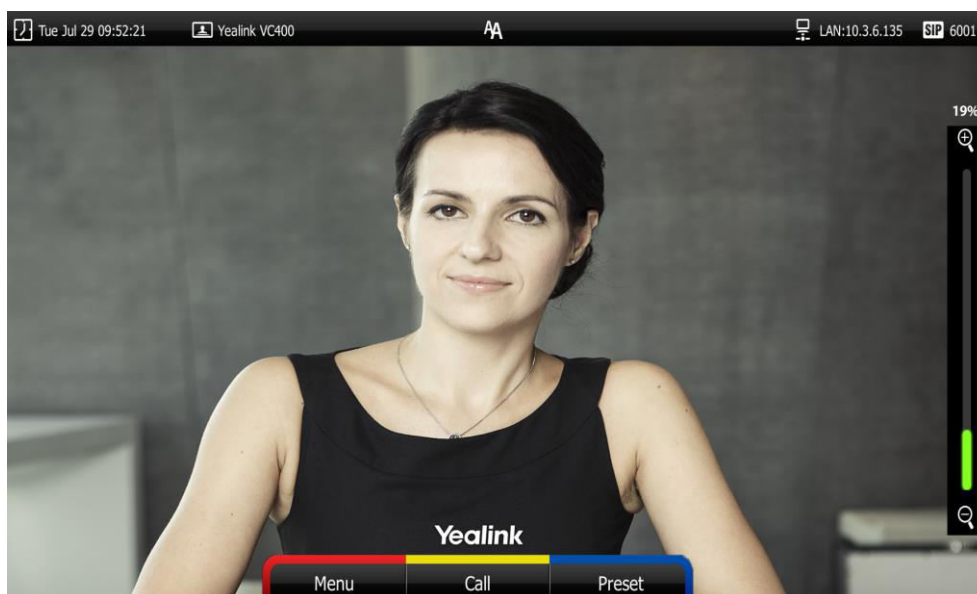

To save the preset of the camera:



1. Press (**Preset** soft key).
2. Long press any number key (0-9) on the remote control until the screen prompts "Preset Key 'X' successfully saved", ("X" stands for the saved key).
3. Current camera position is saved to the key. You can change the position of the camera to the preset quickly by pressing the saved key during a call.

To control local camera via the remote control during a video call:

- Press ▲ or ▼ to adjust the angle of the camera or long press ⊕ or ⊖ to adjust the focus of the camera.
- Long press any number key (0-9) to save the current preset position of the camera. If preset has been saved to the key, the new preset will be saved to the key.
- Change the position of the camera to the preset by short pressing the saved key.

To control the local camera during a video call via the web user interface, at the path **Home** (Hover your cursor over the registered account, click , and then control the camera in the pop-up window).

To control remote camera via the remote control during a video call:

1. Press  (**More** soft key) during an active call.
2. Press ▲ or ▼ to scroll to **Near/Far Camera**, and then press .
3. Select the remote video, and then press .
4. You can do the following:
 - Press ▲ or ▼ to adjust the angle of the remote camera or long press ⊕ or ⊖ to adjust the focus of the remote camera.
 - Long press any number key (0-9) to save the current preset position of the remote camera.
 - Change the position of the remote camera to the preset by press the saved key.

Note

You cannot control the remote camera if only the **Far Control Set of Near Camera** feature is enabled.

Changing the Video Input Source



VC400 video conferencing system supports two video input sources: camera and PC.

When the camera and PC are connected to the VC400 codec, the display device displays the presentation on the connected PC. If two display devices are connected to the VC400 codec, the video image is shown on the main display device, and the presentation on the PC is shown on the second display device.

During a call, the display device will display differently depending on whether it has connected to a second display device or the selected video input source.

You can change the video input source via the remote control and web user interface.

To change video input when the system is idle via the remote control:

1. Press  .
The display device shows **Camera** and **PC** input sources.
2. Press ◀ or ▶ to select the desired input source, and then press .

The display device shows the selected source.

To change video input during a call:

1. Press .

The display device shows **Camera, Camera and PC** and **PC** input sources.

2. Press ◀ or ▶ to select the desired input source, and then press .

The display device shows the selected source.

Video input can be configured via the web user interface at the path **Home->Input**.

Video Recording



You can record local video via the remote control when the system is idle. During a call, the video and presentation which are shown on the display device can be recorded via the remote control and VCP40 phone.

Before recording video, you need to insert a USB flash drive into the USB port on the VC400 codec to store recorded video. The recorded video will be saved in .mkv format and named as the recorded time and date. You can view or delete the recorded video via the remote control.

Note

The system only supports USB flash drive in FAT32 format.

After the USB flash drive is inserted to the USB port on the VC400 codec, the display device will prompt "USB device available, press * to record or press # to screenshot".

The  icon will appear on the status bar of the display device, and the  icon will appear on the LCD screen of the VCP40 phone.

You can play the recorded videos in a computer with a player supports .mkv format.

To record video when the system is idle via the remote control:

1. Press  to start recording.

The display device shows  and the recording time.

2. Press  again to end stop recording.

The recording icon disappears from the screen and the display device prompts "Successfully video recording!".

To record video during a call via the remote control:

Do one of the following:

- Press  on the remote control to start recording.
- Press the **Start REC** soft key on the VCP40 phone to start recording.

The display device shows  and the recording time. The LCD screen of the VCP40 phone is shown as below:







Press  on the remote control or press the **Stop REC** soft key on the VCP40 phone to stop recording.

The recording icon disappears from the screen, and the display device prompts "Successfully video recording!".



Ending the call will stop recording video automatically.

To view recorded video via the remote control:

Insert the USB flash drive with the recorded video.



1. Press  (**Menu** soft key) to enter main menu.
2. Press ◀ or ▶ to select the **Record** menu.
3. Press ▲ or ▼ to scroll to **Videos**, and then press .
4. Press ▲ or ▼ to select the desired **Video**.
5. Press  or  (**Play** soft key).

You can do the following:

- Press ◀ or ▶ to rewind or skip the video.
Each press will rewind the video 8 seconds or skip the video forward 8 seconds.
- Press  (**Stop** soft key) to stop playing video.
- Press  (**Pause** soft key) to pause Video.

When receiving an incoming call while you are playing record, the system will stop playing video automatically.

To delete recorded video via the remote control:

1. Press  (**Menu** soft key) to enter main menu.
2. Press ◀ or ▶ to select the **Record** menu.
3. Press ▲ or ▼ to scroll to **Videos**, and then press .
4. Press ▲ or ▼ to select the desired **Video**.
5. Press  (**Delete** soft key).

The display device prompts "Delete this video?"

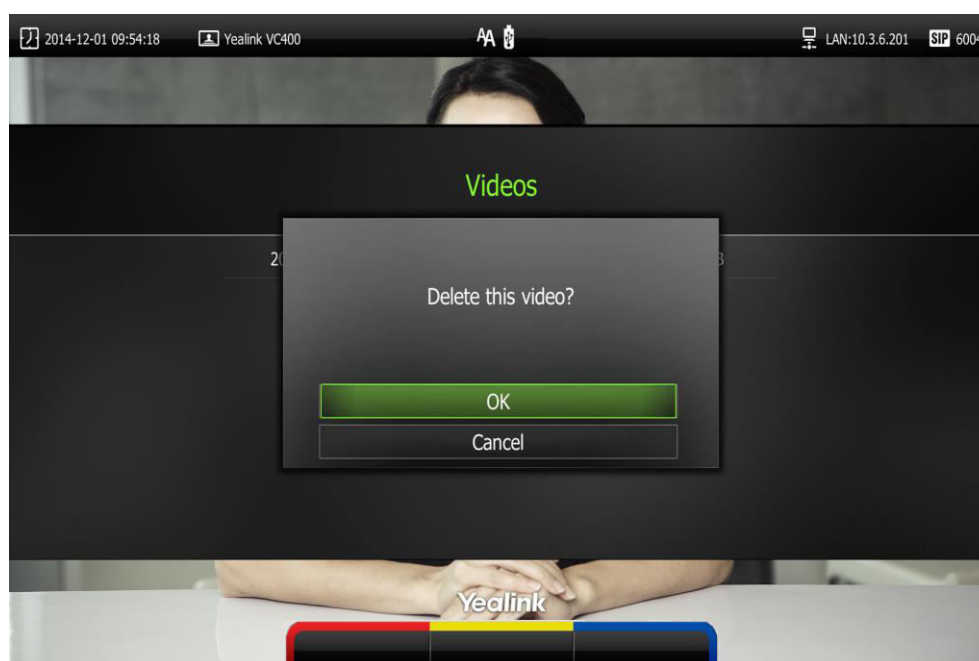

6. Select **OK**, and then press  to delete the video.

Screenshot

You can capture the screenshot from the camera via the remote control or web user interface. Before capturing the screenshot, you need to insert a USB flash drive to the USB port on the VC400 codec to store screenshots. You can view, delete or scale the screenshots via the remote control.

When you capture a screenshot via the web user interface, you can save the screenshots to the computer. The stored screenshot will be saved in .jpg format and named after the captured time and date.

Note

The system only supports USB flash drive in FAT32 format.



After the USB flash drive is inserted into the USB port on the VC400 codec, the display device will prompt "USB device available, press * to record or press # to screenshot".

The  icon will appear on the status bar of the display device, and the **USB** icon will appear on the LCD screen of the VCP40 phone.





The system supports capturing one screenshot per second.

You can play the recorded videos in a computer.



To capture screenshots via the remote control:

1. Press  when the system is idle or during a call.
The  icon shows a "+1" animated effects.



To view screenshots via the remote control:

1. Press  (**Menu** soft key) to enter main menu.
2. Press ◀ or ▶ to select the **Record** menu.
3. Press ▲ or ▼ to scroll to **Screenshots**, and then press .
4. Press ▲ or ▼ to select desired screenshots.
5. Press  or  (**View** soft key).

You can do one of the following:

- Press ◀ or ▶ to view previous or next screenshot.
- Press  or  to zoom in or zoom out the screenshot.
- Press  (**Original size** soft key) to view the original size of the screenshot.

To delete screenshots via the remote control:

1. Press  (**Menu** soft key) to enter main menu.
2. Press ◀ or ▶ to select the **Record** menu.
3. Press ▲ or ▼ to scroll to **Screenshots**, and then press .
4. Press ▲ or ▼ to select desired screenshots.
5. Press  (**Delete** soft key).

The display device prompts "Delete this screenshot?"

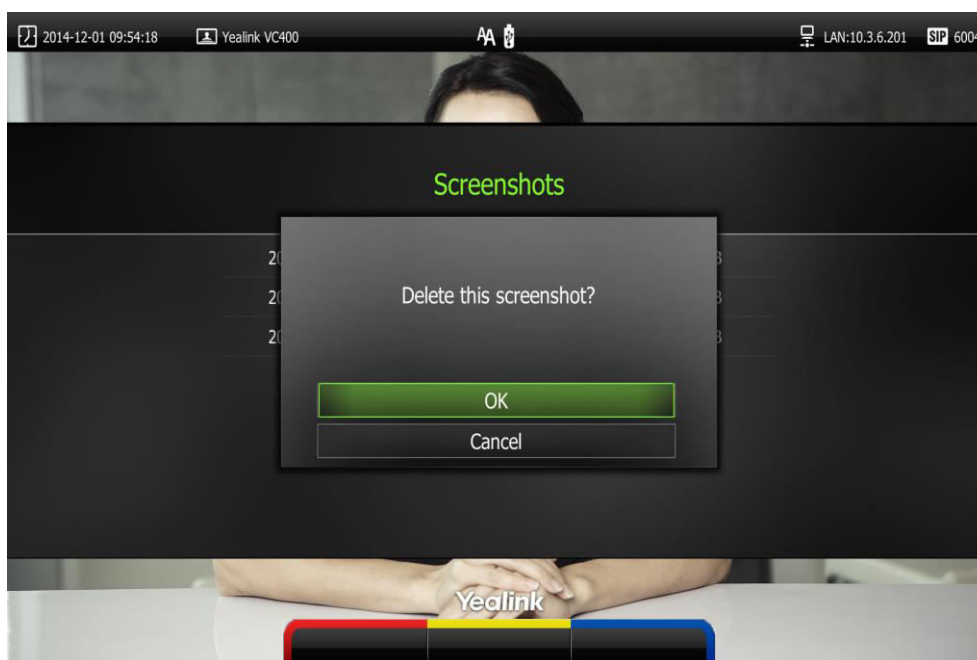

6. Select **OK**, and then press  to delete the screenshot.

Capture the screenshot via the web user interface at the path **Home->Screenshot**.

Troubleshooting

This chapter provides general troubleshooting information to help you solve problems you might encounter when using your VC400 system.



If you require additional information or assistance to help you use your new phone, contact your system administrator.

System Diagnostics

Diagnostic menus include:

- **Audio Diagnose:** Check whether the audio output device can pick up voice and play audio normally.
- **Camera Diagnose:** Check whether the camera can pan and change focus normally.
- **Ping:** Check whether the network between the local and the remote system is connected.
- **Trace Route:** Check every network node between the local and the remote system, and the time cost between every two network nodes.





Audio Diagnose:

1. Press  (**Menu** soft key) to enter main menu.
2. Press ◀ or ▶ to select the **Diagnose** menu.
3. Press ▲ or ▼ to scroll to **Audio Diagnose**, and then press .
4. Speak into the microphone.
5. Check whether the microphone can pick up audio normally.

If the microphone picks up audio and plays back audio normally, it means that the audio works well.

6. Press  to stop audio diagnostics.





Camera Diagnose:

1. Press  (**Menu** soft key) to enter main menu.
2. Press ◀ or ▶ to select the **Diagnose** menu.
3. Press ▲ or ▼ to scroll to **Camera Diagnose**, and then press .
4. Press ▲ or ▼ to adjust the camera position.
5. Long press  or  to adjust the focus.





If the camera can move and zoom normally, it means that the camera is working well.

6. Press  (**Back** soft key) to stop camera diagnostics.

Network diagnosis:

1. Press  (**Menu** soft key) to enter main menu.
2. Press ◀ or ▶ to select the **Diagnose** menu.
3. Press ▲ or ▼ to scroll to **Ping**, and then press .
4. Enter IP address (for example, the IP address of the remote system)
5. Press ▲ or ▼ to select **Start**, and then press .
6. Press  (**Back** soft key) to return to Diagnose menu.

Trace Route:

1. Press  (**Menu** soft key) to enter main menu.
2. Press ◀ or ▶ to select the **Diagnose** menu.
3. Press ▲ or ▼ to scroll to **Trace Route**, and then press .
4. Enter IP address (for example, the IP address of the remote system)
5. Press ▲ or ▼ to select **Start**, and then press .
6. Press  (**Back** soft key) to return to Diagnose menu.

General Issues

Why can't the system place a call?

- Check the network is available.
- When making a call using an account, check that the account is registered.
- Ensure the remote system supports the same call type as the local system. If you want to place a call using another type, refer to [Call Type](#) on page 59.

Why can't the system receive calls?



- Check the network is available.
- When receiving a call using an account, check that the account is registered.
- Check that DND (Do Not Disturb) mode is deactivated on your system. Refer to [Do Not Disturb \(DND\)](#) on page 70.

Why doesn't the display device display the time and date correctly?

Check whether you have configured the system to obtain the time and date from the SNTP server automatically. If the system fails to connect to the SNTP server, contact your system administrator for more information. You can also configure the time and date manually. For more information, refer to [Time & Date](#) on page 37.

How to obtain the IP address of the system?

There are three ways to obtain the IP address of the system:

- The IP address of the system is shown on the top right corner of the display device.
- Press  (Menu soft key) on your remote control and select **Network**.
The display device shows the network information about the system.
- Press  on the VCP40 phone when the phone is idle and select **Network**.
The LCD screen of the phone displays the network information about the system.

Why the system fails to conduct a video conference?

- Check the network is configured correctly and available, and that the display device doesn't create a network anomaly.
- Ensure that the local system can ping the IP address of the remote system.
- Ensure that the entered call information is correct.
- Ensure that the called party is powered on.
- Ensure that a call can be established between the local and the remote system.
- Troubleshoot the problem according to the prompts.

Camera Issues

How to adjust room lighting?

You can alter the environmental lighting and background colors of your environment to obtain the best video quality. If light levels are too low you may consider adding artificial lighting. Reflected light from pale walls often produces excellent results.

Avoid the following situations:

- Direct sunlight on the display device, the background, or the camera lens which creates harsh contrasts.
- Colored lighting.

Why can't I adjust the camera angle and focus?

- You can adjust the camera when the system is idle or during a call. The camera cannot be adjusted when the system is in the menu screen.
- Ensure that the batteries in the remote control are in good working condition, and installed correctly.
- Aim the remote control at the sensor when you perform a task.
- Ensure that no objects are obstructing the sensor on the front of the camera.
- Ensure that the LED on the front of the camera flashes red when you use the remote

control to perform a task.

- Ensure that what you are controlling is the local camera.
- Reboot the system.
- If the above suggestions cannot solve your problem, perhaps the remote control is broken. You can contact your system administrator for help.

Why is the video quality bad?

- Ensure that the display device has suitable resolution.
- Check whether the packet has been lost. For more information about packet loss, refer to [Call Statistics](#) on page 74.
- Contact your administrator to adjust the camera brightness and white balance.

Display Issues

Why is there no video on the display device?

- Ensure that the display device is turned on.
- Ensure that the display device is properly connected to VC400codec.
- Ensure that the VC400 codec is turned on.
- Ensure that you have selected the correct video input source.

Why can't the display device share a presentation?



- Ensure that the PC is properly connected to the VC400 codec.
- Ensure that the VC400 codec is turned on.
- Contact your administrator for help.

Video & Audio Issues

Why can't I hear the audio during a call?











- Ensure that the system has selected an available audio output device.
- If you select **VCS Phone** as the audio output device, ensure that the VCP40 phone is connected to the VC400 codec, and LED indicators on the phone illuminate solid green.
- Ensure the proper volume level on the system.
- Ensure that the microphone on the remote system is not muted.

Why can't I hear a ring tone when receiving a call?

- Ensure that the system has selected an available audio output device.
- If you select **VCS Phone** as the audio output device, ensure that the VCP40 phone is connected to the VC400 codec, and LED indicators on the phone illuminate solid green.
- Ensure that the ring volume is not set to 0. If it is, the  icon will appear on the status bar of display device, and the  icon will appear on the LCD screen of the VCP40 phone.
- Adjust the ring volume when the system is idle via the remote control or VCP40 phone. For more information, refer to [Audio Settings](#) on page 40.
- Ensure that the microphone of the remote system is not muted.

System Maintenance

How to reboot the phone?

1. Press  (**Menu** soft key) to enter main menu.
2. Press  or  to scroll to the **Advanced** menu.
3. Enter admin password (default password: 0000) in the **Admin Password** field.
4. Press  or press  (**Enter** soft key).
5. Press  or  to scroll to **Reboot & Reset**, and then press .
6. Press  or  to scroll to **Reboot**, and then press .

The display device prompts "Reboot the system?".

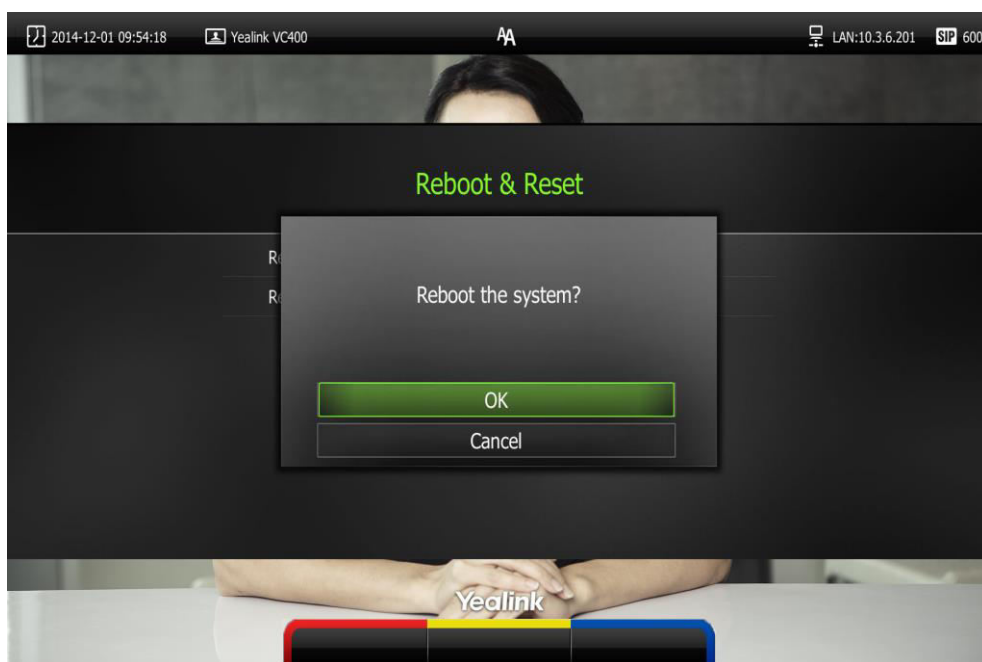

7. Select **OK**, and then press .

You can reboot the system via the web user interface at the path **Setting->Upgrade**.

How to export PCAP trace?

We may need you to provide a PCAP trace to help analyze your problem. Exporting PCAP trace is only configurable via the web user interface.

To export a PCAP trace via the web user interface:

1. Click on **Settings->Configuration**.
2. Click **Start** to begin capturing signal traffic.

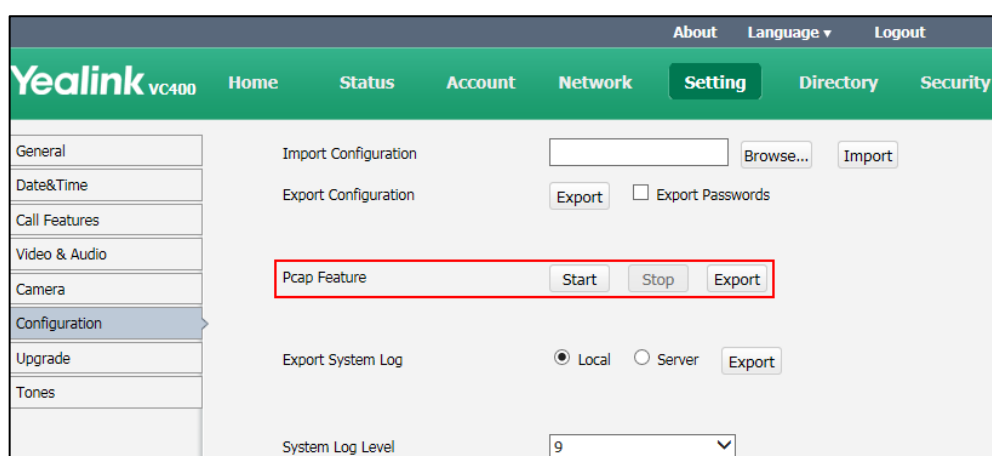

3. Recreate the error to be documented in the trace.
4. Click **Stop** to stop the capture.
5. Click **Export** to open the file download window, and then save the file to your local system.

How to export system log?

We may need you to provide your phone configurations to help analyze your problems. You can export the system log to the local system or designated log server.

To export the system log to a local PC via the web user interface:

1. Click on **Settings->Configuration**.
2. Mark the **Local** radio box in the **Export System Log** field.
3. Select **9** from the pull-down list of **System Log Level**.

The default system log level is 9.

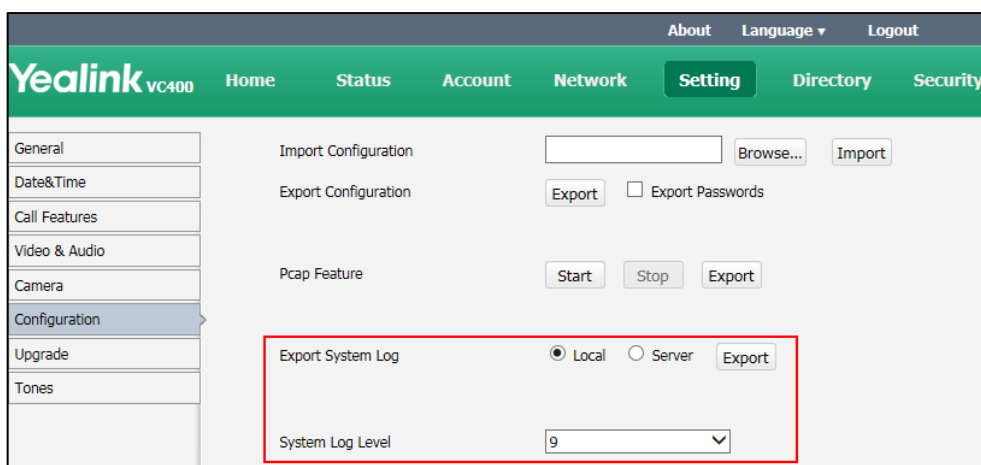

4. Click **Confirm** to accept the change.
The web user interface prompts “Operating...Please wait...”.
Export the system log referring to the following steps.
5. Recreate the error to be documented in the trace.
6. Click **Export** to save the file to your local system.

How to export/import the system configurations?

We may need you to provide your system configurations to help analyze problems. In some instance, you may need to import configurations to your system.

To export the system configurations via the web user interface:

1. Click on **Setting->Configuration**.
2. Check or uncheck the **Export Passwords** checkbox according to actual demand.
3. Click **Export**.

If you check the **Export Passwords** checkbox, the web user interface is shown as below:

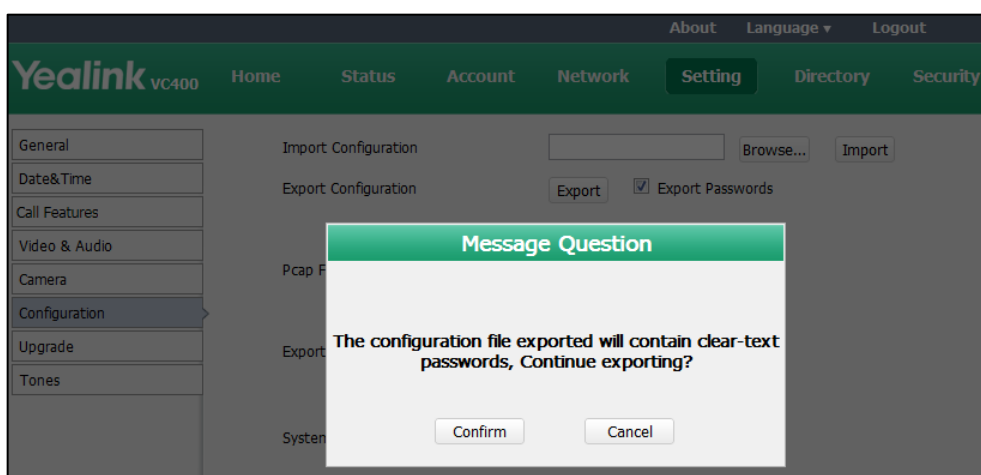

4. Click **Confirm** to export the configurations.

To import the phone configurations via the web user interface:

1. Click on **Setting->Configuration**.
2. Click **Browse** to locate a configuration file from your local system.

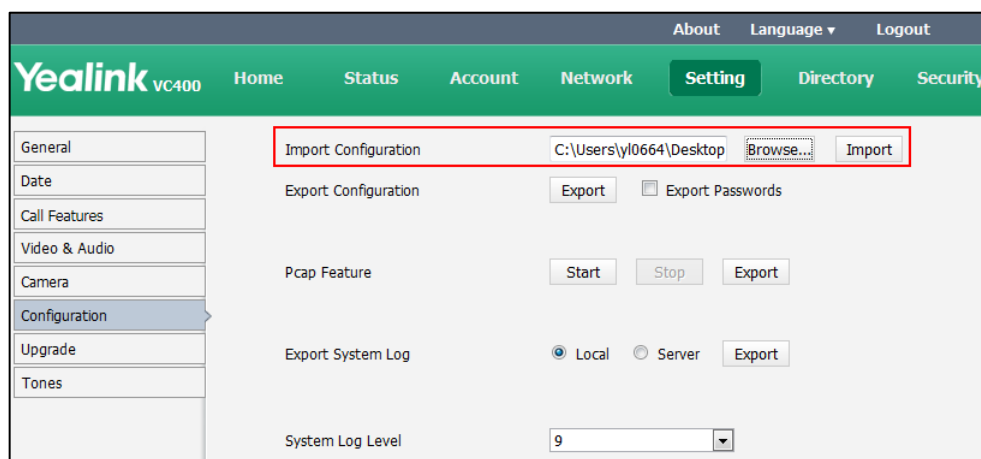

3. Click **Import** to import the configuration file.

Note The file format of configuration file must be *.bin.

How to upgrade firmware?

To upgrade firmware via the web user interface:

1. Click on **Setting->Upgrade**.
2. Click **Browse** to locate the firmware from your local system.

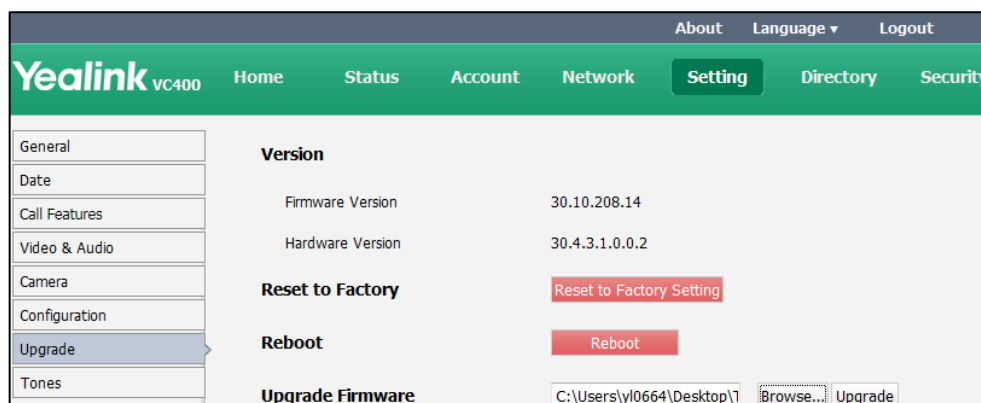

3. Click **Upgrade** to upgrade the firmware.

The browser pops up the dialog box "Firmware of the video conference system will be updated. It will take 5 minutes to complete. Please don't power off!".

4. Click **Confirm** to confirm upgrading.



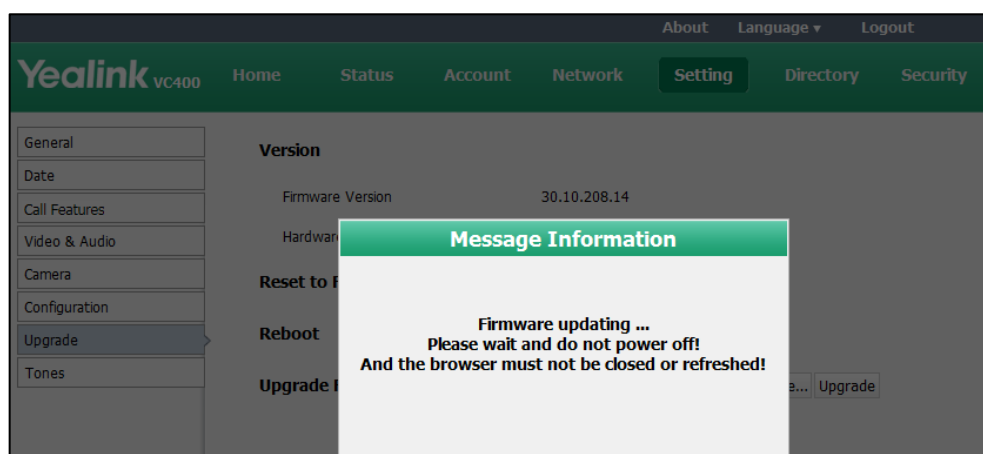

The web user interface is shown as below:



How to reset the system?

Reset the system to factory configurations after you have tried all appropriate troubleshooting suggestions but have still do not solved the problem. You need to note that all customized settings will be overwritten after reset. You can reset the system via the remote control or web user interface.

To reset the system via the remote control:

1. Press  (Menu soft key) to enter main menu.
2. Press ◀ or ▶ to scroll to the **Advanced** menu.
3. Enter admin password (default password: 0000) in the **Admin Password** field.
4. Press  or Press  (Enter soft key).
5. Press ▲ or ▼ to scroll to **Reboot & Reset**, and then press .
6. Press ▲ or ▼ to scroll to **Reset**, and then press .

The display device prompts "Reset to Factory? "

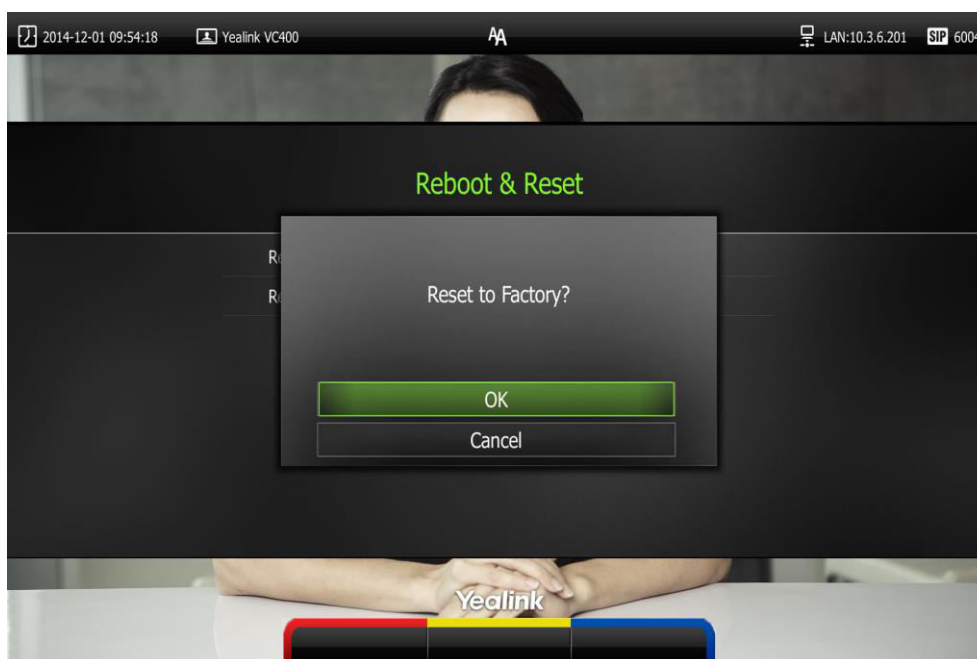

7. Select **OK**, and then press **OK**.

The system reboots automatically, the LCD screen of the VCP40 phone prompts "Rebooting Please wait...". The phone will be reset to factory successfully after startup.

Note

Reset of the system may take a few minutes. Do not power off until the phone starts up successfully.

Resetting the system can be configured via the web user interface at the path **Setting->Upgrade->Reset to Factory**.

Regulatory Notices

Service Agreements

Contact your Yealink Authorized Reseller for information about service agreements applicable to your product.

Limitations of Liability

TO THE FULL EXTENT ALLOWED BY LAW, YEALINK EXCLUDES FOR ITSELF AND ITS SUPPLIERS ANY LIABILITY, WHETHER BASED IN CONTRACT OR TORT (INCLUDING NEGLIGENCE), FOR INCIDENTAL, CONSEQUENTIAL, INDIRECT, SPECIAL, OR PUNITIVE DAMAGES OF ANY KIND, OR FOR LOSS OF REVENUE OR PROFITS, LOSS OF BUSINESS, LOSS OF INFORMATION OR DATA, OR OTHER FINANCIAL LOSS ARISING OUT OF OR IN CONNECTION WITH THE SALE, INSTALLATION, MAINTENANCE, USE, PERFORMANCE, FAILURE, OR INTERRUPTION OF ITS PRODUCTS, EVEN IF YEALINK OR ITS AUTHORIZED RESELLER HAS BEEN ADVISED OF THE POSSIBILITY OF SUCH DAMAGES, AND LIMITS ITS LIABILITY TO REPAIR, REPLACEMENT, OR REFUND OF THE PURCHASE PRICE PAID, AT YEALINK'S OPTION. THIS DISCLAIMER OF LIABILITY FOR DAMAGES WILL NOT BE AFFECTED IF ANY REMEDY PROVIDED HEREIN SHALL FAIL OF ITS ESSENTIAL PURPOSE.

Safety Instructions

Save these instructions. Read these safety instructions before use!

The following basic safety precautions should always be followed to reduce the risk of fire, electrical shock, and other personal injury.



General Requirements

- Before you install and use the device, read the safety instructions carefully and monitor the situation during operation.
- During the process of storage, transportation, and operation, please always keep the device dry and clean.
- During the process of storage, transportation, and operation, please avoid collision and an impact to the device.
- Please do not attempt to dismantle the device by yourself. In case of any discrepancy, please contact the appointed maintenance center for repair.
- Without prior written consent, no organization or individual is permitted to make any change to the structure or the safety design of the device. Yealink is under no circumstance liable to consequences or legal issues caused by such changes.
- Please refer to the relevant laws and statutes while using the device. The legal rights of others should be respected as well.

Environmental Requirements



- Place the device in a well-ventilated place. Do not expose the device to direct sunlight.
- Keep the device dry and free of dust.
- Place the device on a stable and level platform.
- Please do not place any heavy objects on the device in case of damage and deformation caused by the heavy load.
- Keep at least 10 cm between the device and the closest object for heat dissipation.
- Do not place the device on or near any inflammable or fire-vulnerable object, such as rubber-made materials.
- Keep the device away from any heat source or bare fire, such as a candle or an electric heater.
- Keep the device away from any household appliance with a strong magnetic field or electromagnetic field, such as a microwave oven or a refrigerator.



Operating Requirements

- Do not let a child operate the device without guidance.
- Do not let a child play with the device or any accessory in case of accidental swallowing.
- Please only use accessories provided or authorized by the manufacturer only.
- The power supply of the device shall meet the requirements of the input voltage of the device. Please only use the surge protection power socket provided.
- Before plugging or unplugging any cable, ensure that your hands are completely dry.
- Do not spill liquid of any kind on the product or use the equipment near water, for example, near a bathtub, washbowl, kitchen sink, wet basement or near a swimming pool.
- Do not tread on, pull, or over-bend any cable in case of malfunction of the device.
- During a thunderstorm, stop using the device and disconnect it from the power supply. Unplug the power plug and the Asymmetric Digital Subscriber Line (ADSL) twisted pair (the radio frequency cable) to avoid lightning strike.
- If the device is left unused for a rather long time, disconnect it from the power supply and unplug the power plug.
- When smoke or an abnormal noise or smell is emitted from the device, disconnect the device from the power supply, and unplug the power plug immediately. Contact the specified maintenance center for repair.
- Do not insert any object into equipment slots that is not part of the product or auxiliary product.
- Before connecting a cable, connect the grounding cable of the device first. Do not disconnect the grounding cable until you disconnect all other cables.

Cleaning Requirements

- Before cleaning the device, stop using it and disconnect it from the power supply.
- Use a piece of soft, dry and anti-static cloth to clean the device.
- Keep the power plug clean and dry. Using a dirty or wet power plug may lead to electric shock or other perils.

Restriction of Hazardous Substances

Restriction of Hazardous Substances (RoHS) is a Chinese government regulation which aims to restrict certain dangerous substances commonly used in electronic and electronic equipment.

The following table lists the names and content of toxic and hazardous substances or elements probably contained in the products:

Parts Name	Toxic or Hazardous Substance and Elements					
	Lead (Pb)	Mercury (Hg)	Cadmium (Cd)	Hexavalent Chromium (Cr ⁺⁶)	Polybrominated Biphenyls (PBB)	Polybrominated Diphenyl Ethers (PBDE)
Plastic and Polymeric Parts	O	O	O	O	O	O
Metal Parts	X	O	O	O	O	O
PCBA	X	O	O	O	O	O
Cables and Cable Assemblies	O	O	O	O	O	O
LCD Screen	O	O	O	O	O	O
Batteries	O	O	O	O	O	O
Packing Material	O	O	O	O	O	O

O: Indicates that toxic substances contained in all homogeneous materials in this product are below the limit requirement in GB/T26572-2011 standard.

X: Indicates that toxic substances contained in all homogeneous materials in this product are above the limit requirement in GB/T26572-2011 standard.

This table lists the toxic and hazardous substances contained in the machine. Based on the material type, the data is provided by the supplier and has already been validated by Yealink company.

Some harmful substances contained in the material cannot be replaced according to the current technology. We constantly strive to improve our products.

Appendix A - Time Zones

Time Zone	Time Zone Name
- 11:00	Samoa
- 10:00	United States-Hawaii-Aleutian
- 10:00	United States-Alaska-Aleutian
- 09:00	United States-Alaska Time
- 08:00	Canada(Vancouver, Whitehorse)
- 08:00	Mexico(Tijuana, Mexicali)
- 08:00	United States-Pacific Time
- 07:00	Canada(Edmonton, Calgary)
- 07:00	Mexico(Mazatlan, Chihuahua)
- 07:00	United States-Mountain Time
- 07:00	United States-MST no DST
- 06:00	Canada-Manitoba(Winnipeg)
- 06:00	Chile(Easter Islands)
- 06:00	Mexico(Mexico City, Acapulco)
- 06:00	United States-Central Time
- 05:00	Bahamas(Nassau)
- 05:00	Canada(Montreal, Ottawa, Quebec)
- 05:00	Cuba(Havana)
- 05:00	United States-Eastern Time
- 04:30	Venezuela(Caracas)
- 04:00	Canada(Halifax, Saint John)
- 04:00	Chile(Santiago)
- 04:00	Paraguay(Asuncion)
- 04:00	United Kingdom-Bermuda(Bermuda)
- 04:00	United Kingdom(Falkland Islands)
- 04:00	Trinidad&Tobago
- 03:30	Canada-New Foundland(St.Johns)
- 03:00	Denmark-Greenland(Nuuk)
- 03:00	Argentina(Buenos Aires)
- 03:00	Brazil(no DST)
- 03:00	Brazil(DST)
- 02:00	Brazil(no DST)
- 01:00	Portugal(Azores)
0	GMT
0	Greenland
0	Denmark-Faroe Islands(Torshavn)
0	Ireland(Dublin)

Time Zone	Time Zone Name
0	Portugal(Lisboa, Porto, Funchal)
0	Spain-Canary Islands(Las Palmas)
0	United Kingdom(London)
0	Morocco
+01:00	Albania(Tirane)
+01:00	Austria(Vienna)
+01:00	Belgium(Brussels)
+01:00	Caicos
+01:00	Chad
+01:00	Spain(Madrid)
+01:00	Croatia(Zagreb)
+01:00	Czech Republic(Prague)
+01:00	Denmark(Kopenhagen)
+01:00	France(Paris)
+01:00	Germany(Berlin)
+01:00	Hungary(Budapest)
+01:00	Italy(Rome)
+01:00	Luxembourg(Luxembourg)
+01:00	Macedonia(Skopje)
+01:00	Netherlands(Amsterdam)
+01:00	Namibia(Windhoek)
+02:00	Estonia(Tallinn)
+02:00	Finland(Helsinki)
+02:00	Gaza Strip(Gaza)
+02:00	Greece(Athens)
+02:00	Israel(Tel Aviv)
+02:00	Jordan(Amman)
+02:00	Latvia(Riga)
+02:00	Lebanon(Beirut)
+02:00	Moldova(Kishinev)
+02:00	Russia(Kaliningrad)
+02:00	Romania(Bucharest)
+02:00	Syria(Damascus)
+02:00	Turkey(Ankara)
+02:00	Ukraine(Kyiv, Odessa)
+03:00	East Africa Time
+03:00	Iraq(Baghdad)
+03:00	Russia(Moscow)
+03:30	Iran(Teheran)
+04:00	Armenia(Yerevan)
+04:00	Azerbaijan(Baku)
+04:00	Georgia(Tbilisi)

Time Zone	Time Zone Name
+04:00	Kazakhstan(Aktau)
+04:00	Russia(Samara)
+04:30	Afghanistan
+05:00	Kazakhstan(Aqtobe)
+05:00	Kyrgyzstan(Bishkek)
+05:00	Pakistan(Islamabad)
+05:00	Russia(Chelyabinsk)
+05:30	India(Calcutta)
+06:00	Kazakhstan(Astana, Almaty)
+06:00	Russia(Novosibirsk, Omsk)
+07:00	Russia(Krasnoyarsk)
+07:00	Thailand(Bangkok)
+08:00	China(Beijing)
+08:00	Singapore(Singapore)
+08:00	Australia(Perth)
+09:00	Korea(Seoul)
+09:00	Japan(Tokyo)
+09:30	Australia(Adelaide)
+09:30	Australia(Darwin)
+10:00	Australia(Sydney, Melbourne, Canberra)
+10:00	Australia(Brisbane)
+10:00	Australia(Hobart)
+10:00	Russia(Vladivostok)
+10:30	Australia(Lord Howe Islands)
+11:00	New Caledonia(Noumea)
+12:00	New Zealand(Wellington, Auckland)
+12:45	New Zealand(Chatham Islands)
+13:00	Tonga(Nukualofa)

Index

A

- About This Guide [v](#)
- Automatic Sleep Time [33](#)
- Adding Contacts [43](#)
- Audio Settings [40](#)
- Auto Answer [69](#)
- Audio Setting [40](#)
- Audio Input Device [62](#)
- Audio Output Device [61](#)
- Adding a contact from the call history list [58](#)
- Answering or Rejecting Calls [69](#)
- Appendix A - Time Zones [101](#)

B

- Backlight [34](#)
- Bandwidth Settings [60](#)

C

- Customizing VC400 Video Conferencing System [33](#)
- Call Type [59](#)
- Call History Management [54](#)
- Call Statistics [74](#)
- Call Mute [74](#)
- Call Statistics [74](#)
- Changing Video Layout [76](#)
- Controlling the Camera [79](#)
- Contact Management [74](#)
- Changing Video Input Source [81](#)
- Camera Issues [89](#)

D

- Declaration of Conformity [vi](#)
- Deleting Contacts [48](#)
- Do Not Disturb (DND) [70](#)

- Documents [16](#)
- Deleting Contacts [48](#)
- Deleting an entry from the call history list [57](#)
- Display Issues [90](#)

E

- Editing Contacts [47](#)
- Ending Calls [72](#)
- Entering Data and Editing Fields [28](#)

G

- General Settings [33](#)
- Getting Started [17](#)
- General Issues [88](#)

H

- System Component Instructions [4](#)

I

- Icon Instructions [11](#)
- Importing/Exporting Contact lists [51](#)
- In This Guide [v](#)
- Idle Screen Display [26](#)

K

- Key Tone [39](#)

L

- Language [36](#)
- LED Instructions [13](#)
- Limitation of Liability [97](#)
- Local Directory [42](#)

N

- Network Connection [14](#)
- Navigating Menus on the Display Device [27](#)

P

- Packaging Contents [1](#)
- Presentation [75](#)
- Placing Calls [65](#)
- Place a call from the call history list [56](#)

O

- Overview [1](#)

R

- Remote Control [14](#)
- Registration [25](#)
- Regulatory Notices [97](#)
- Restriction of Hazardous Substances [99](#)

S

- Safety Instructions [97](#)
- Setup Wizard [22](#)
- Change Video Input Source [81](#)
- Search Source List in Dialing [49](#)
- System Installation [17](#)
- System Status [29](#)
- Site Name [35](#)
- System Diagnostics [87](#)
- System Maintenance [91](#)
- Searching for Contacts [49](#)
- Service Agreements [97](#)
- Screenshot [84](#)

T

- Time & Date [37](#)
- Troubleshooting [87](#)
- Placing a Call Using the Remote Control [66](#)
- Placing a Call Using the VCP40 IP Phone [67](#)
- Placing a Call via the web user interface [67](#)
- Place Multiple Calls [67](#)

U

- User Interfaces [14](#)
- Using VC400 Video Conferencing System [65](#)

V

- V400 Codec [4](#)
- Viewing Call History [55](#)
- VCC18 HD Camera [5](#)
- VCP40 Conferencing Phone [6](#)
- VCR10 Remote Control [9](#)
- Video Recording [82](#)
- Video & Audio Issues [90](#)

W

- Warranty [vi](#)
- Web User Interface [15](#)
- WEEE Warning [vii](#)