

Yealink



W52P IP DECT Phone User Guide

Version 81.12
Aug. 2018

Copyright

Copyright © 2017 YEALINK(XIAMEN) NETWORK TECHNOLOGY CO., LTD.

Copyright © 2017 Yealink(Xiamen) Network Technology CO., LTD. All rights reserved. No parts of this publication may be reproduced or transmitted in any form or by any means, electronic or mechanical, photocopying, recording, or otherwise, for any purpose, without the express written permission of Yealink(Xiamen) Network Technology CO., LTD. Under the law, reproducing includes translating into another language or format.

When this publication is made available on media, Yealink(Xiamen) Network Technology CO., LTD. gives its consent to downloading and printing copies of the content provided in this file only for private use but not for redistribution. No parts of this publication may be subject to alteration, modification or commercial use. Yealink(Xiamen) Network Technology CO., LTD. will not be liable for any damages arising from use of an illegally modified or altered publication.

Warranty

THE SPECIFICATIONS AND INFORMATION REGARDING THE PRODUCTS IN THIS GUIDE ARE SUBJECT TO CHANGE WITHOUT NOTICE. ALL STATEMENTS, INFORMATION, AND RECOMMENDATIONS IN THIS GUIDE ARE BELIEVED TO BE ACCURATE AND PRESENTED WITHOUT WARRANTY OF ANY KIND, EXPRESS OR IMPLIED. USERS MUST TAKE FULL RESPONSIBILITY FOR THEIR APPLICATION OF PRODUCTS.

YEALINK(XIAMEN) NETWORK TECHNOLOGY CO., LTD. MAKES NO WARRANTY OF ANY KIND WITH REGARD TO THIS GUIDE, INCLUDING, BUT NOT LIMITED TO, THE IMPLIED WARRANTIES OF MERCHANTABILITY AND FITNESS FOR A PARTICULAR PURPOSE. Yealink(Xiamen) Network Technology CO., LTD. shall not be liable for errors contained herein nor for incidental or consequential damages in connection with the furnishing, performance, or use of this guide.

Declaration of Conformity

Hereby, Yealink(Xiamen) Network Technology CO., LTD. declares that this phone is in conformity with the essential requirements and other relevant provisions of the CE, FCC.

For European, this device is a DECT Portable station operating in the frequency band of 1880MHz to 1990MHz.

For US, This telephone is compliant with the DECT 6.0 standard which operates in the 1.92GHz to 1.93GHz frequency range.

CE Mark Warning

This device is marked with the CE mark in compliance with EC Directives 1999/5/EC (R&TTE).

This device complies with the following standards:

1. Safety: EN 60950-1:2006+A11:2009+A1:2010+A12:2011
2. SAR: EN62479:2010
3. EMC: ETSI EN 301 489-1 V1.9.2 (2011-09) & ETSI EN 301 489-6 V1.3.1 (2008-08)
4. Radio: ETSI EN 301 406 V2.1.1 (2009-07)

Part 15 FCC Rules

This device complies with Part 15 of the FCC Rules. Operation is subject to the following two conditions:

1. This device may not cause harmful interference, and
2. this device must accept any interference received, including interference that may cause undesired operation.

Industry Canada (IC)

This Class [B] digital apparatus complies with Canadian ICES-003 & ICRSS-247 Rules.

Operation is subject to the following conditions:

1. This device may not cause interference.
2. This device must accept any interference, including interference that may cause undesired operation of the device.

Privacy of communications may not be ensured when using this telephone.

Class B Digital Device or Peripheral

This equipment is tested and complies with the limits for a Class B digital device, pursuant to Part 15 of the FCC Rules.

These limits are designed to provide reasonable protection against harmful interference in a residential installation.

This equipment generates, uses, and can radiate radio frequency energy and, if not installed and used in accordance with the instructions, may cause harmful interference to radio communications. However, there is no guarantee that interference will not occur in a particular installation. Privacy of communications may not be ensured when using this telephone. If this equipment does cause harmful interference to radio or television reception, which can be determined by turning the equipment off and on, the user is encouraged to try to correct the interference by one or more of the following measures:

1. Reorient or relocate the receiving antenna.
2. Increase the separation between the equipment and receiver.
3. Connect the equipment into an outlet on a circuit different from that to which the receiver is connected.
4. Consult the dealer or an experience radio/TV technician for help.

Note: Changes or modifications not expressly approved by Yealink(Xiamen) Network Technology Co., Ltd could void the user's authority to operate the equipment.

ACTA Information

This equipment complies with Part 68 of the FCC rules and the requirements adopted by the ACTA. On the bottom of the base station is a label that contains, among other information, a product identifier in the format US: T2LXXXXXX.

Hearing Aid Compatibility (HAC)

This telephone system meets FCC standards for Hearing Aid Compatibility.

FCC RF Radiation Exposure Statement

This equipment complies with FCC RF radiation exposure limits set forth for an uncontrolled environment.

This equipment should be installed and operated with a minimum distance of 20 centimeters between the radiator and your body. This transmitter must not be co-located or operated in conjunction with any other antenna or transmitter.

For body worn operation, this phone has been tested and meets the FCC RF exposure guidelines when used with the belt clip supplied with this product. Use of other accessories may not ensure compliance with FCC RF exposure guidelines.

Information for DECT Product



This telephone is compliant with the DECT 6.0 standard which operates in the 1.92GHz to 1.93GHz frequency range. Installation of this equipment is subject to notification and coordination with UTAM. Any relocation of this equipment must be coordinated through and approved by UTAM. UTAM may be contacted at 1-800-429-8826.

WEEE Warning



To avoid the potential effects on the environment and human health as a result of the presence of hazardous substances in electrical and electronic equipment, end users of electrical and electronic equipment should understand the meaning of the crossed-out wheeled bin symbol. Do not dispose of WEEE as unsorted municipal waste and have to collect such WEEE separately.

Customer Feedback

We are striving to improve our documentation quality and we appreciate your feedback. Email your opinions and comments to DocsFeedback@yealink.com.

GNU GPL INFORMATION

Yealink W52P IP DECT phone firmware contains third-party software under the GNU General Public License (GPL). Yealink uses software under the specific terms of the GPL. Please refer to the GPL for the exact terms and conditions of the license.

The original GPL license, source code of components licensed under GPL and used in Yealink products can be downloaded online:

<http://www.yealink.com/GPLOpenSource.aspx?BaseInfoCateId=293&NewsCateId=293&CateId=293>.

Generic Access Profile

Yealink W52P IP DECT phones conform to Generic Access Profile (GAP) standard to support some features (e.g., Call Encryption and Registration Management) defined in the GAP. It should be noted that Yealink W52P IP DECT phones are not compatible with the base station and handset from other manufacturers.

About This Guide

Yealink W52P IP DECT phone is a full-featured mobile device, which can provide reliable and convenient wireless voice communications. In addition, it provides many widely accepted benefits of the DECT standard, including high security, scalability, and low power consumption to better meet your requirements.

This guide provides everything you need to quickly use your new phone. First, verify with your system administrator that the network is ready for phone configuration. Also be sure to read the Packaging Contents and Regulatory Notices sections in this guide before you set up and use your W52P IP DECT phone.

In This Guide

Topics provided in this guide include:

- Chapter 1 [Getting Started](#)
- Chapter 2 [Overview](#)
- Chapter 3 [Basic Operations](#)
- Chapter 4 [Phone Settings](#)
- Chapter 5 [Call Features](#)

Table of Contents

About This Guide.....vii

In This Guide.....vii

Table of Contents.....viii

Getting Started..... 1

Packaging Contents1
Connecting the Base Station.....4
Setting up the W52H Handset5
 Handset Information6
 Battery Information6
Setting up the Charger Cradle7
Charging the Handset.....7

Overview 9

Base Station Description9
Handset Description 10
LCD Screen Display 12
 Idle Screen 12
Icon Instructions 13
User Interfaces 13
 Handset User Interface 14
 Web User Interface 14

Basic Operations..... 15

Menu Guidance 15
 Main Menu 15
 Submenu 16
 Returning to Idle Screen 17
Entering Data and Editing Fields..... 17
 Configuring the Input Modes 17
 Editing Fields 17
 Entering Data..... 18
Handset Registration 19
 Registering a Handset 19

Selecting Base Station	20
Renaming Base Station.....	20
Basic Network Settings	21
Configuring Static IP Address	21
Configuring Static DNS When DHCP is Enabled.....	22
Checking System Status.....	23
Registering Accounts	24
Turning Handset On/Off	25
Adjusting Volume	25
Locking/Unlocking Keypad	25
Switching Silent Mode to On/Off	26
Locating a Handset.....	26
Phone Settings	29
Handset Name	30
Language	30
Ring Tones	31
Advisory Tones	31
Backlight	32
Screen Saver	32
Color Schemes	32
Keypad Light.....	33
Notification Light.....	33
Date and Time	33
Shortcuts.....	38
Contact Management	39
Local Directory.....	39
Blacklist.....	41
Remote Phone Book.....	42
Call History Management	44
Dial Plan.....	45
Replace Rule	46
Area Code.....	48
Block Out.....	48
Emergency Numbers	49
Outgoing Lines	50
Incoming Lines.....	51
Key As Send	53
Speed Dial.....	53
Assigning a Speed Dial Number	53
Changing a Speed Dial Number	54
Deleting a Speed Dial Number	54
Placing a Call Using Speed Dial Key	55
Auto Answer	55

Auto Intercom.....	55
Base Restart	56
Base PIN.....	56
Base Reset.....	56
Handset Reset.....	57
Auto Provision	57
Eco Mode+	58
Eco Mode.....	58
Repeater Mode	59
Call Features	61
Placing Calls.....	61
Placing Internal Calls	62
Placing External Calls.....	63
Answering Calls.....	64
Ending Calls	64
Redialing Calls	65
Call Mute	65
Call Hold/Resume	66
Call Waiting	66
Do Not Disturb (DND)	67
Call Forward.....	68
Call Transfer	68
Conference Call.....	70
Local Conference	70
Network Conference.....	71
Anonymous Call.....	73
Anonymous Call Rejection	74
Voice Mail	75
Shared Call Appearance (SCA)	77
Configuring SCA Feature	78
Using SCA Feature on the Handset	80
Multicast Paging	82
Sending RTP Stream	83
Receiving RTP Stream.....	85
Using Multicast Paging.....	86
Troubleshooting.....	87
Base Issue	87
Handset Issue	87
Register Issue.....	88
Call Issue.....	88
Paging Issue.....	88

Audio Issue 88

Display Issue 89

Update & Reset Issue 89

Log Issue..... 90

Appendix..... 95

 Appendix A - Time Zones 95

 Appendix B - Menu Structure 97

 Appendix C - Input Modes and Characters..... 98

Regulatory Notices..... 101

 Important Safety Information 101

Index 103

Getting Started

This chapter provides basic installation instructions and information for obtaining the best performance with the W52P IP DECT phone. Topics include:

- [Packaging Contents](#)
- [Connecting the Base Station](#)
- [Setting up the W52H Handset](#)
- [Setting up the Charger Cradle](#)
- [Charging the Handset](#)

If you require additional information or assistance with your new DECT phone, contact your system administrator.

Packaging Contents

The following components are included in your W52P IP DECT phone package and W52H package:

W52P IP DECT Phone Package	W52H Package
<ul style="list-style-type: none"> • 1 Base Station • 1 Handset • 1 Charge Cradle • 2 Power Adapters • 2 Rechargeable Batteries • 1 Ethernet Cable • 1 Belt Clip • 1 Quick Start Guide 	<ul style="list-style-type: none"> • 1 Handset • 1 Charge Cradle • 1 Power Adapter • 2 Rechargeable Batteries • 1 Belt Clip

Note We recommend that you use the accessories provided or approved by Yealink. The use of unapproved third-party accessories may result in reduced performance.

- **Base Station**

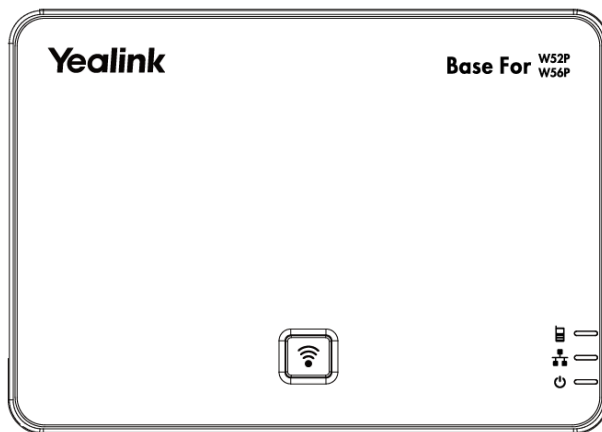

Note Yealink W52P IP DECT phone consists of one Base for W52P/W56P and one W52H Handset.

- **W52H Handset**

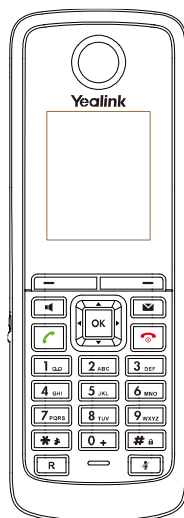

- **Charger Cradle**

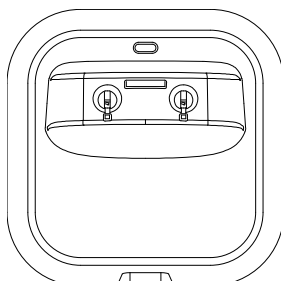

- **Power Adapter**

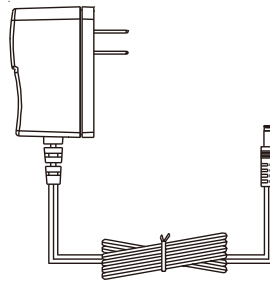

- **Two Rechargeable Batteries**

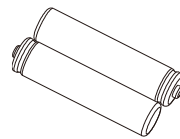

- **Ethernet Cable**

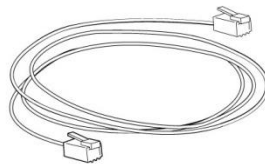

- **Belt Clip**

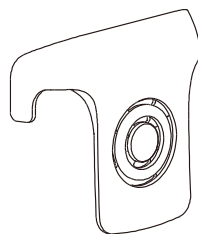

- **Quick Start Guide**



Check the package before installation. If you find anything missing, contact your system administrator.

Connecting the Base Station

You have two options for power and network connection of the base station. Your system administrator will advise you which one to use.

- AC power
- Power over Ethernet (PoE)

Note

Please pay attention to the radio coverage of the base station. It is up to 300m in unobstructed outdoor areas and up to 50m inside buildings.

Do not set up the base station in a damp room, and keep away from the water.

AC Power

To connect the AC power:

1. Connect the DC plug on the power adapter to the DC5V port on the base station and connect the other end of the power adapter into an electrical power outlet.
2. Connect the included or a standard Ethernet cable between the Internet port on the base station and the Internet port in your network or the switch/hub device port.

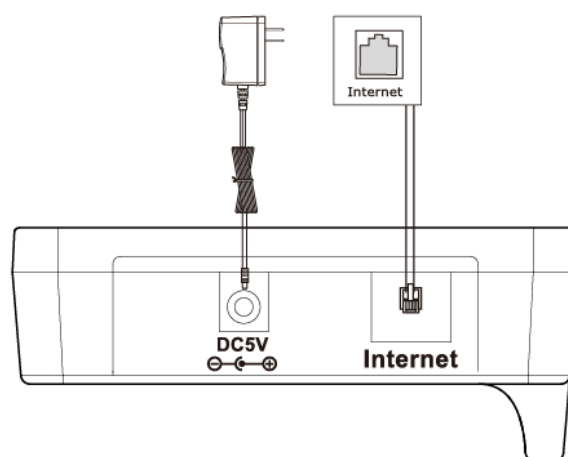

Note

The base station should be used with Yealink original power adapter (5V/600mA) only. The use of the third-party power adapter may cause the damage to the base station.

Power over Ethernet

With the included or a regular Ethernet cable, the base station can be powered from a PoE-compliant (IEEE 802.3af) switch or hub.

To connect the PoE:

1. Connect the Ethernet cable between the Internet port on the base station and an available port on the in-line power switch/hub.

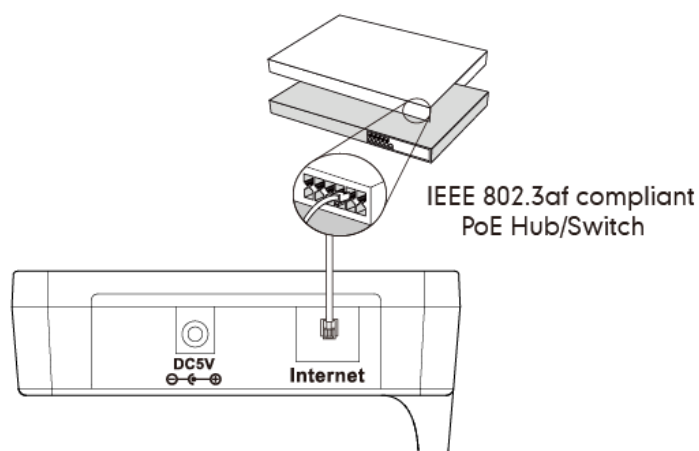
**Note**

If in-line power is provided, you don't need to connect the AC adapter. Make sure the switch/hub is PoE compliant.

Important! Do not remove the power and network to the base station while it is updating firmware and configurations.

Setting up the W52H Handset

To insert batteries into the handset:

1. Open the battery cover.
2. Insert the batteries in the correct polarity.
3. Close the battery cover.

**Note**

Do not short-circuit the battery, as short-circuiting the terminals may damage the battery or the handset.

Do not use a damaged battery, as this may cause an explosion.

Before replacing the battery, please turn off the handset to prevent memory loss.

Handset Information

The handset provides 1.8" color screen, and six changeable shortcut keys. It also supports a 2.5mm jack for earphone connection.

For the maintenance, read and follow as shown below:

1. Do not use the handset near sources of electric such as microwave oven, TV sets or radios.
2. Keep the handset away from fire and moisture. Do not use the handset outdoors in the rain or handle it with wet hands.
3. Clean it only with a soft cloth. Do not use excess water or cleaning solvents of any kind.
4. Care should be taken that not to fall onto the floor.
5. Do not disassemble the handset.

Battery Information

We strongly recommend you use the same type rechargeable battery, or it may damage the unit.

Technology: Nickel Metal Hydride (NiMH)

Size: AAA

Voltage: 1.2V

Capacity: 800mAh

We strongly recommend you use the batteries complying with the above parameters. Because the compliant ones can guarantee the specified operating time, full functionality and long service life. The operating time of your handset depends on the capacity and age of the batteries and the way they are used.

We recommend you use only the batteries that came with the handset or replacement batteries approved by Yealink technology:

- Sanyo NiMH 800
- GP 850 mAh
- Yuasa Technologies AAA 800

Battery Capacity

The capacity of the battery depends on the use of backlight and talk time.

Charging time: approximately 6 hours (fully discharged to full capacity).

Standby time: up to 100 hours when the backlight is disabled.

Talk time: up to 10 hours active talk time (with full charged batteries).

The operating time of your handset depends on the capacity and age of the battery and the way they are used.

Battery Disposal

To reduce the risk of dangerous or injury to persons, read and follow as shown below:

- Keep the batteries away from the heat sources and high voltages.
- Please store them safely and stay in a half-charged state when the batteries are not used for a long time.
- Don't disassemble or assemble the batteries by yourself.
- Don't heat and burn of the batteries or throw them in fire.
- Don't contact the leaking batteries directly.

Setting up the Charger Cradle

1. Connect the DC plug on the power adapter to the DC5V port on the charger cradle.
2. Connect the other end of the power adapter into an electrical power outlet.

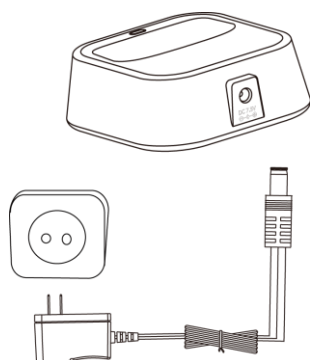

Charging the Handset

To charge the handset:

1. After setting up the handset and charger cradle, place the handset into the charger cradle.

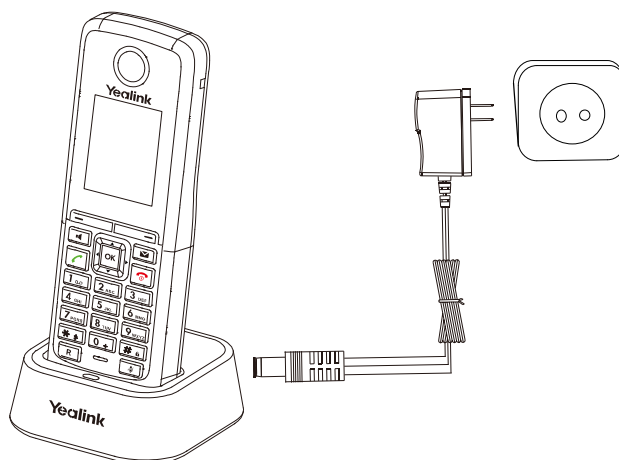







Note

The handset should be used with Yealink original power adapter (5V/600mA) only. The use of the third-party power adapter may cause the damage to the handset.

Battery Charging Status

The handset batteries take 6 hours to fully charge. Charging status of batteries is displayed on the top right-hand corner of the LCD screen:

Icon	Charging Status
	Fully Charged
	75% Charged
	50% Charged
	25% Charged
	10% Charged
	Almost Flat

Note

Don't charge battery near a fire source or in direct sunlight.

When the capacity of battery is low, and the handset is not charged timely, the handset will display a prompt box.

Overview

This chapter provides the overview of the W52P IP DECT phone. Topics include:

- [Base Station Description](#)
- [Handset Description](#)
- [LCD Screen Display](#)
- [Icon Instructions](#)
- [User Interfaces](#)

If you require additional information or assistance with your new phone, contact your system administrator.

Base Station Description

After the base station starts up successfully and the handset is registered to the base station, all LEDs on the base station illuminate green in sequence.

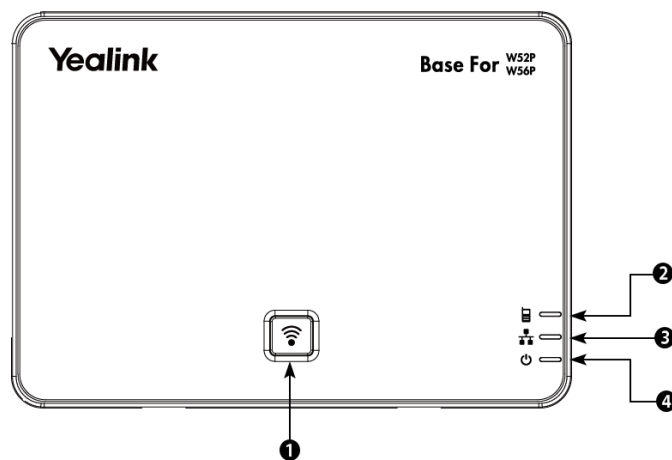

Hardware component instructions of the base station are:

	Item	Description
①	Paging Key	<ul style="list-style-type: none"> • Locates a misplaced handset. • Toggles the registration mode. • Resets the base station to factory settings.
②	Registration LED	<p>Indicates the mode of the base station:</p> <ul style="list-style-type: none"> • Fast-flashing green—The base station is in the paging mode. • Slow-flashing green—The base station is in the registration mode. • Solid green—There is at least one handset registered to the base station.





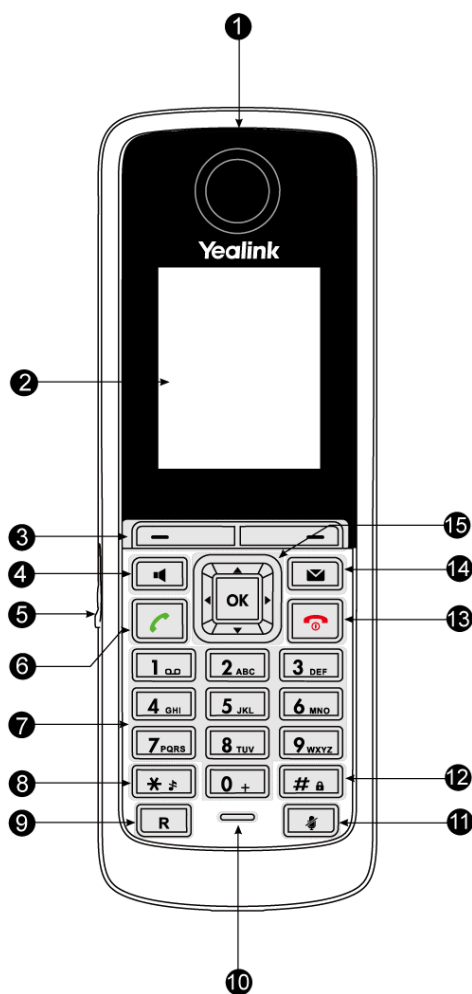

	Item	Description
		<ul style="list-style-type: none"> • Off—The base station is powered off or no handsets are registered to the base station.
③	Network Status LED	Indicates the network status: <ul style="list-style-type: none"> • Slow flashing green—The network is unavailable. • Solid green—The network is available. • Off—The base station is powered off.
④	Power Indicator LED	Indicates the power status of the base station: <ul style="list-style-type: none"> • Slow flashing green—The base station is during the firmware upgrading process. • Solid green—The base station is powered on. • Off—The base station is powered off.

Handset Description

The main hardware components of the W52H handset are the LCD screen and the keypad.



Hardware component instructions of the W52H handset are:

	Item	Description
①	Earpiece	Outputs audio during the earpiece call.
②	LCD Screen	Shows information about calls, messages, soft keys, time, date and other relevant data.
③	Soft Keys	Label automatically to identify their context-sensitive features.
④	Speakerphone Key	<ul style="list-style-type: none"> • Switches among the earpiece, earphone and speakerphone modes. • Answers an incoming call. • Places a call in speakerphone mode.
⑤	Headset Connector	Allows you to connect a standard 2.5mm earphone.
⑥	Off-hook Key	<ul style="list-style-type: none"> • Answers an incoming call. • Enters the redial calls list. • Places a call in earpiece or earphone mode.
⑦	Keypad	Provides digits, letters and special characters in context-sensitive applications.
⑧		<ul style="list-style-type: none"> • Enters the star symbol and other special characters. • Switches the silent mode to On or Off.
⑨	 (Redirect Key)	Transfers a call to another party.
⑩	Microphone	Picks up audio during earpiece and hands-free calls.
⑪	Mute Key	Toggles mute feature on or off.
⑫		<ul style="list-style-type: none"> • Enters the pound symbol. • Locks or unlocks the handset keypad. • Switches the input method.
⑬	On-hook Key/Power Key	<ul style="list-style-type: none"> • Press on any screen to return to previous screen. • Long press on any screen to return to the idle screen. • Press to turn the handset on. • Long press on idle screen to turn the handset off. • Cancels actions or ends a call. • Rejects an incoming call.
⑭	Message Key	<ul style="list-style-type: none"> • Indicates a new voice mail or missed call. • Accesses the voice mail or the missed call list.
⑮	 	<ul style="list-style-type: none"> • Move the cursor. • Act as shortcuts. • Scroll through the displaying information.
	 	<ul style="list-style-type: none"> • Move the cursor. • Act as shortcuts. • Adjust the ringer volume. • Switch among the values.

	Item	Description
		Confirms actions or enters the main menu.

LCD Screen Display





Idle Screen

If the handset starts up successfully, the idle screen will be displayed as below.



















The LCD screen is divided into three parts: status line, text line and soft key line.

Idle Screen description:

Field	Description
Status Line	<ul style="list-style-type: none"> • On hook (idle) – displays the signal strength indicator, internal handset number and battery status. • Off hook – displays line ID. <p>Signal strength:</p> <p>Weak to strong: </p> <p>No reception: </p> <p>Battery status:</p> <p>Low to full: </p> <p>Need charging: </p>
Text Line	<ul style="list-style-type: none"> • On hook (idle) – displays handset name, time and date, caller information when receiving an incoming call and prompt messages. • Off hook – displays the dialed digits.
Soft Key Line	<ul style="list-style-type: none"> • On hook (idle) – displays History and Line. • Off hook – displays various terms according to the context of the specific feature.

Icon Instructions

Icons appearing on the LCD screen are described in the following table:

Icon	Description
	Anonymous call is enabled.
	Anonymous call rejection is enabled.
	Missed Call
	Voice Mail
	Keypad Lock
	Silent Mode
	Do Not Disturb (DND)
	Call Forward
	Call Hold
	Call Mute
	Unassigned Outgoing Line
	Unusable Line
	Earpiece Mode On
	Speakerphone Mode On
	Earphone Mode On
	Normal Call

User Interfaces

Two ways to customize configurations of your DECT phone:

- The user interface on the handset.
- The user interface in a web browser on your PC.

The hardware components keypad and LCD screen of handset constitute the handset user interface, which allows the user to execute all call operation tasks and basic configuration changes directly on the handset. In addition, you can use the web user interface to access some configuration settings.

Handset User Interface

You can customize your handset by pressing the **OK** key to access the main menu. Some options are only accessible to the administrator, and the default administrator password is "0000".

Web User Interface

In addition to the handset user interface, you can also customize some features via web user interface. In order to access the web user interface, you need to know the IP address of your DECT phone. To obtain the IP address, press **OK->Status->Base** on the handset when the handset is idle. Enter the IP address (e.g., <http://192.168.0.10> or 192.168.0.10) in the address bar of a web browser on your PC. The default administrator user name and password are both "admin" (case-sensitive).

Note

The access to the Advanced settings of the Account or Network via web user interface may be blocked by the web browser (e.g., Chrome, Firefox) if you have installed "Adblock Plus plugin".

Basic Operations

This chapter provides you with the basic operating instructions of the W52P IP DECT phone.

Topics include:

- [Menu Guidance](#)
- [Entering Data and Editing Fields](#)
- [Handset Registration](#)
- [Basic Network Settings](#)
- [Checking System Status](#)
- [Registering Account](#)
- [Turning Handset On/Off](#)
- [Adjusting Volume](#)
- [Locking/Unlocking Keypad](#)
- [Switching Silent Mode to On/Off](#)
- [Locating a Handset](#)

If you require additional information or assistance with your new phone, contact your system administrator.

Menu Guidance

The handset provides a variety of features that are grouped into menu. This section provides you with some basic guidance of accessing and navigating the menu. For a quick overview of features in each menu, refer to [Appendix B - Menu Structure](#) on page 97.

Main Menu

The handset menu has a number of levels. The main menu is the top-level menu, which consists of six menu items: Status, Intercom, Voice Mail, Call Features, Directory and Settings.







Main Menu Screen description:

No.	Description
Menu Item	Displays the selected menu item name.
Main menu	<p>Displays the main menu icon:</p> <p>Status—To display the base, handset and line status.</p> <p>Intercom—To make an internal call.</p> <p>Voice Mail—To set and view voice mail(s).</p> <p>Call Features—To access the features of Call Forward, Do Not Disturb, Call Waiting, Anon.Call Rejection, Anonymous Call and Paging.</p> <p>Directory—To access the directory and manage the contacts.</p> <p>Settings—To configure the handset settings.</p>
Soft Keys	Displays the two soft key labels.

To enter the main menu via the handset:

1. Press  when the handset is idle.
The seven menus appear as a list of icons on the LCD screen.

To access a main menu feature via the handset:

1. Press , ,  or  to scroll through the seven menus.
The name of the selected menu item appears on the top of the LCD screen.
2. Press  or the **OK** soft key to enter the corresponding menu.





Note

You can only access Status and Settings menus if the handset does not register to a base station. For more information on the menu, refer to [Appendix B - Menu Structure](#) on page 97.

Submenu

The submenus are displayed on the LCD screen and they are shown as a list. You can access features by entering the submenu.

To access features of a submenu via the handset:

1. Press  or  to highlight the desired submenu.
2. Press  or the **OK** soft key to access features of the submenu.
You can press  or the **Back** soft key to return to the previous screen.

For more details about the submenu, refer to [Appendix B - Menu Structure](#) on page 97.

Returning to Idle Screen

To return to the idle screen via the handset:

1. Long press  to quickly exit the menu and return to the idle screen.

If you do not press any key in a period of time, the LCD screen will automatically exit the menu and return to the idle screen.

Note

When you are navigating the menu, the LCD screen will automatically exit the menu if an incoming call arrives. The incoming call can be handled as usual. When the call is terminated, the LCD screen will return to the idle screen.

Entering Data and Editing Fields

You can enter and edit data in the corresponding field using the handset keypad.



Configuring the Input Modes

The handset provides you with 12 different input modes. Keypad on the handset provides different characters (or numbers) when using different input modes.

For more details on the input modes and character (or number) options for the keypad, refer to [Appendix C - Input Modes and Characters](#) on page 98.

You can enable the frequently used input mode. Then you can switch among the enabled input modes when entering or editing.

To configure the input mode via the handset:

1. Press  to enter the main menu.
2. Select **Settings->Display->Input Method**.
The LCD screen displays all available input modes.
3. Press  or  to highlight the desired input mode.
4. Press the **Change** soft key to check or uncheck the checkbox.

Editing Fields

There are limitations for certain types of the fields on handset as follow:









- **Name and Password field:** enter any characters that the handset provided.
- **Number field:** only enter the numeric characters, dot or #.
- **IP address field:** enter the 32-bit IPv4 address or 128-bit IPv6 address.

Entering Data

In corresponding input mode, you can press the keypad repeatedly to view the character (or numbers) options and press more times to highlight the desired character (or number), the available character under each key appears on the bottom left-hand corner of the LCD screen. Wait one second, and enter the next character (or number).

The default input methods are **Abc**, **123**, **ABC** and **abc**.

To enter or edit data by the default input modes, do one of the following as shown below:

If you want to	Then you can
Switch among input modes.	Press  one or more times to switch among input modes (depending on the input mode you've configured, refer to Configuring the Input Mode on page 17). The current input mode is displayed on the bottom right-hand corner of the LCD screen.
Enter only digits (1), uppercase (A) characters or lowercase (a) characters.	Press a keypad key one or more times (depending on what input mode you're in) to enter the characters that are displayed on the keypad key. For example, if the input mode is ABC : <ul style="list-style-type: none"> - To enter "A", press  once. - To enter "B", press  twice quickly. - To enter "C", press  three times quickly. For other input modes, refer to Appendix C - Input Modes and Characters on page 98.
Enter special characters.	Press  to select the space character or the following special characters: _ ' " = / \ ^ ; : . , - + * # \$ % & @ ? ! ; i () { } [] < > ¥ £ \$ ~ ¢ For  Key: <ul style="list-style-type: none"> - If it is in the uppercase (ABC soft key), uppercase and lowercase (Abc soft key) or lowercase (abc soft key) input modes, it will provide space character and the following special characters: . , ? , ! , 0. - If it is in the numeric (123 soft key) input mode, it will only provide the digit 0. - Long press the key to enter the character +. For other input modes, refer to Appendix C - Input Modes and Characters on page 98.
Delete text you entered.	Press  or  to position the cursor to the right of the text you want to delete, and then press the Del

If you want to	Then you can
	soft key to delete one character at a time or long press to delete all characters.

Handset Registration

Each handset can be registered up to 4 different base stations. You can select the desired base to use and rename it.

Note

You can register up to 5 handsets to one base station by default. The administrator can limit that how many handsets can be registered to one base station. Contact your system administrator for more information.

Registering a Handset

When the handset LCD screen prompts "Press base paging 2s then press Reg.", long press  on the base station till the registration LED flashes. There are two methods to register a new handset:

Easy Registration:

1. Press the **Reg** soft key on the handset to register quickly.

Normal Registration:

1. Press the **OK** soft key on the handset, and then select **Register Handset**.
2. Select the desired base and then press the **OK** soft key. The handset begins searching the base.
3. Press the **OK** soft key after searching a base successfully.
4. Enter the base PIN (default: 0000), and then press the **Done** soft key to complete registration.

After the success of registration, the handset LCD screen prompts "Handset Subscribed" and "Base NO. (The last 4 characters of connected Base's MAC address)".

After initializing data successfully, an icon with internal handset number and handset name appears on the LCD screen.

To register to multiple base stations:

1. Press the **OK** key to enter the main menu.
2. Select **Settings->Registration->Register Handset**.
3. Repeat steps 2-4 mentioned in normal registration to register multiple base stations.

You can also enable the registration mode of the base station via web user interface at the path **Status->Handset&VoIP->Register New Handsets**.

Note

If the handset LCD screen prompts "Searching for Base", please check if your base station is powered on.

To de-register a handset via the handset:

1. Press to enter the main menu.
2. Select **Settings->Registration->De-reg. Handset**.
3. Enter the system PIN (default: 0000), and then press the **Done** soft key.
The LCD screen displays the names of handsets that registered to the same base station.
The name of the handset itself is highlighted and followed by a left arrow.
4. Press or to highlight the desired handset name, and then press the **OK** soft key.
The LCD screen prompts "De-register Handset".
5. Press the **Yes** soft key to de-register the handset or the **No** soft key to cancel.

De-register handset via the web user interface at the path: **Status->Handset&VoIP->Delete Handset**.

Selecting Base Station

If one handset is registered on multiple base stations, it will be automatically connected to one of them. You can select a desired base to register, or select the best base to automatically register with the strongest signal strength.



To select the base station via the handset:

1. Press to enter the main menu.
2. Select **Settings->Registration->Select Base**.
The LCD screen displays all base stations that the handset is registered to and the **Bestbase** option. The radio box of the currently used base station with the last 4 characters of MAC address is marked.
3. Press or to highlight the desired base station or the **Bestbase** option, and then press the **Select** soft key.
The handset begins to search for base station. After successful connection, the handset LCD screen prompts "Base selected successfully!".

Renaming Base Station

To rename the base station via the handset:



1. Press to enter the main menu.
2. Select **Settings->Registration->Select Base**.
3. Press or to highlight the desired registered base station (except **Bestbase** option).

4. Press the **Rename** soft key, and then input the desired name in the **Rename** field.
You can press  to enter special characters and press  to switch among different input modes.
5. Press the **Save** soft key to accept the change.

Basic Network Settings

The base station attempts to contact a DHCP server in your network to obtain valid network settings (e.g., IP address, subnet mask, gateway address and DNS address) by default. The IP DECT phone can support either or both IPv4 and IPv6 addresses modes, but IPv6 is disabled by default.

To configure the IP address mode via handset user interface:

1. Press  to enter the main menu.
2. Select **Settings**->**System Settings**->**Network** (default PIN: 0000) ->**Basic**.
3. Press  or  to select **IPv4**, **IPv6** or **IPv4&IPv6** from the **IP Mode** field.
4. Press the **Save** soft key to accept the change or the **Back** soft key to cancel.

Note





Wrong network settings may result in inaccessibility of your DECT phone and may also have an impact on your network performance. For more information on these parameters, contact your system administrator.

Configuring Static IP Address

If the base station cannot contact a DHCP server for any reason, you need to configure basic network settings manually.

You can configure a static IPv4 address for the IP phone. Before configuring it, make sure that the IP mode is configured as **IPv4** or **IPv4&IPv6**.





To configure static IPv4 IP address manually via the handset:

1. Press  to enter the main menu.
2. Select **Settings**->**System Settings**->**Network** (default PIN: 0000) ->**Basic**.
3. Press  to select **IPv4**, and then press the **OK** soft key.
4. Press  or  to select **Static** from the **IP Address Type** field.
5. Enter the valid value in the **IP Address**, **Subnet Mask**, **Default Gateway**, **Primary DNS** and **Secondary DNS** field respectively.
6. Press the **Save** soft key to accept the change.

The base station reboots automatically to make settings effective after a period of time.

You can also configure a static IPv6 address for the IP phone. Before configuring it, make sure that the IP mode is configured as **IPv6** or **IPv4&IPv6**.

To configure static IPv6 IP address manually via the handset:

1. Press  to enter the main menu.
2. Select **Settings**->**System Settings**->**Network** (default PIN: 0000) -> **Basic**.
3. Press  to select **IPv6**, and then press the **OK** soft key.
4. Press  or  to select **Static** from the **IP Address Type** field.
5. Enter the valid value in the **IP Address**, **IPv6 Prefix**, **Default Gateway**, **Primary DNS** and **Secondary DNS** field respectively.
6. Press the **Save** soft key to accept the change.





The base station reboots automatically to make settings effective after a period of time.

Configuring Static DNS When DHCP is Enabled

Static DNS is not normally required when DHCP is enabled on your phone. In some cases, static DNS may be needed in your environment. Then you can manually configure static DNS to ignore DNS obtained from DHCP.

You can configure a static IPv4 DNS for the IP phone. Before configuring it, make sure that the IP mode is configured as **IPv4** or **IPv4&IPv6**.





To configure static IPv4 DNS manually via the handset:

1. Press  to enter the main menu.
2. Select **Settings**->**System Settings**->**Network** (default PIN: 0000) -> **Basic**.
3. Press  to select **IPv4**, and then press the **OK** soft key.
4. Press  or  to select **Manual** from the **DNS Type** field when **DHCP** is selected from the **IP Address Type** field.
5. Enter the valid value in the **Primary DNS** and **Secondary DNS** field respectively.
6. Press the **Save** soft key to accept the change or the **Back** soft key to cancel.

The base station reboots automatically to make settings effective after a period of time.

You can also configure a static IPv6 DNS for the IP phone. Before configuring it, make sure that the IP mode is configured as **IPv6** or **IPv4&IPv6**.

To configure static IPv6 DNS manually via the handset:

1. Press  to enter the main menu.
2. Select **Settings**->**System Settings**->**Network** (default PIN: 0000) -> **Basic**.
3. Press  to select **IPv6**, and then press the **OK** soft key.
4. Press  or  to select **Manual** from the **DNS Type** field when **DHCP** is selected from the **IP Address Type** field.
5. Enter the valid value in the **Primary DNS** and **Secondary DNS** field respectively.
6. Press the **Save** soft key to accept the change or the **Back** soft key to cancel.

The base station reboots automatically to make settings effective after a period of time.

Checking System Status



You can view the system status on your handset. Available information of the system status includes:

- **Base station status** (IPv4 status or IPv6 status, firmware version, MAC address, device certificate status, RFPI and network information)
 - IPv4 uses a 32-bit address.
 - IPv6 is an updated version of the current Internet Protocol to meet the increased demands for unique IP addresses, using a 128-bit address.
- **Handset status** (model, hardware version, firmware version, IPUi code, SN code and area)
- **Line status**



Note

You can only check the handset status if the handset does not register to a base station.

To check the base station status via the handset:

1. Press  to enter the main menu.
2. Select **Status->Base**.
The LCD screen displays status information of the base station and the **Network** option.
3. Press  or  to scroll through and view the status information.
4. Select **Network**, and then press the **Enter** soft key.
The LCD screen displays the connected network information.

To check the handset status via the handset:

1. Press  to enter the main menu.
2. Select **Status->Handset**.
The LCD screen displays the status information of the handset.
3. Press  or  to scroll through the status information.

To check the line status via the handset:

Do one of the following:

- Press the **Line** soft key when the handset is idle to check the line status directly.
- Press  to enter the main menu.
Select **Status->Line Status**.

The LCD screen displays all lines registered to the currently used base station with icons for indicating the line status. For example, the icon  at the bottom of a line indicates that you cannot place a call using this line on the handset.

Registering Accounts

The base station supports up to 5 lines. You can register an account for each line via web user interface.

To register an account via web user interface:

1. Click on **Account->Register**.
2. Select the desired account from the pull-down list of **Account**.
3. Select **Enabled** from the pull-down list of **Line Active**.
4. Enter the valid value in the **Label, Display Name, Register Name, User Name, Password** and **SIP Server1/2** field respectively.

The screenshot shows the Yealink W52P/W56P web interface. The 'Account' tab is active, and the 'Register' page is displayed. A red box highlights the 'Line Active' dropdown (set to 'Enabled') and the input fields for 'Label', 'Display Name', 'Register Name', 'User Name', 'Password', 'SIP Server 1' (Server Host, Transport, Server Expires, Server Retry Counts), and 'SIP Server 2' (Server Host, Transport, Server Expires, Server Retry Counts). Other fields include 'Enable Outbound Proxy Server' (Disabled), 'Outbound Proxy Server 1/2', 'Proxy Fallback Interval' (3600), and 'NAT' (Disabled). A 'NOTE' section on the right provides information on 'Account Registration', 'Server Redundancy', and 'NAT Traversal'.

5. If you use the outbound proxy servers, do the following:
 - 1) Select **Enabled** from the pull-down list of **Enable Outbound Proxy Server**.
 - 2) Enter the desired value in the **Outbound Proxy Server 1/2** and **Proxy Fallback Interval** field respectively.
Contact your system administrator for the account information.
6. Click **Confirm** to accept the change.

Turning Handset On/Off

To turn the handset on:

Do one of the following:

- Press . The LCD screen lights up.
- Place the handset in the charger cradle.

The handset can also be turned on automatically when inserting the batteries to the handset.



To turn the handset off:

1. Long press  when the handset is idle.

Adjusting Volume



You can adjust the handset volume according to the noise level of the surrounding environment. The handset supports 5 different volume levels. The default level is 3.

To adjust the volume when the phone is during a call:

1. Press  to decrease the ringer volume, or press  to increase the ringer volume.

The ringer volume can be adjusted using the menu or the predefined shortcuts (left and right navigation keys) on the keypad when the handset is idle.

To adjust ringer volume via the handset:

1. Press  to enter the main menu.
2. Select **Settings->Audio->Ring Tones->Volume**.
3. Press  to decrease the ringer volume, or press  to increase the ringer volume.
4. Press the **Save** soft key to accept the change or the **Back** soft key to cancel.

You can also press  or  to adjust the ringer volume when the handset is idle or ringing.

Note

If the ringer volume is adjusted to the minimum, the icon  will appear on the status bar, and the silent mode will be activated. For more information, refer to [Switching Silent Mode to On/Off](#) on page 26.

Locking/Unlocking Keypad

You can lock the handset keypad to prevent all keys from being accidentally pressed.



To lock the keypad via the handset:

1. Long press  when the handset is idle until the LCD screen prompts "Keypad Locked, Press and hold '#' to unlock!".

The keypad is locked and the icon  appears on the status bar.

You can still answer or reject incoming calls as usual. You can also end the call by pressing .

To unlock the keypad via the handset:

1. Long press  again until the LCD screen prompts "Keypad Unlocked".
The keypad is unlocked and the icon  disappears from the idle screen.



Note

If the keypad is locked, only the emergency numbers can be dialed out. You must enter the emergency number continuously and completely. To place emergency calls, you should configure the emergency numbers in advance. For more information, refer to [Emergency Numbers](#) on page 49.



Switching Silent Mode to On/Off

If the silent mode is switched to On, the handset will not ring when receiving an incoming call, but you can still see the incoming call information on the LCD screen. You can switch the silent mode to On if you do not want to be disturbed.

To switch the silent mode to On via the handset:

1. Long press  until the LCD screen prompts "All Ring Tones Off".
The silent mode is on. The icon  appears on the status bar.

To switch the silent mode to Off via the handset:

1. Long press  again until the LCD screen prompts "All Ring Tones On".
The silent mode is off. The icon  disappears from the status bar.

Note

When the silent mode is activated, the advisory tones will not be played, regardless of their settings.

Locating a Handset

You can locate a misplaced registered handset using the base station.

To locate a handset via the handset:

1. Press  on the base station.
All the handsets that are registered to this base station will ring (paging) simultaneously and display the IP address of the base station on the LCD screen.
This helps you locate your handset easily.

You can press any key on one of the handsets or press  again on the base station to end ring (paging).

You can also locate handsets via web user interface at the path

Status->Handset&VoIP->Paging Status.

Phone Settings

This chapter provides you with some instructions on how to change the settings of your phone.

Topics include:

- [Handset Name](#)
- [Language](#)
- [Ring Tones](#)
- [Advisory Tones](#)
- [Backlight](#)
- [Screen Saver](#)
- [Color Schemes](#)
- [Keypad Light](#)
- [Notification Light](#)
- [Date and Time](#)
- [Shortcuts](#)
- [Contact Management](#)
- [Call History Management](#)
- [Dial Plan](#)
- [Emergency Numbers](#)
- [Outgoing Lines](#)
- [Incoming Lines](#)
- [Key As Send](#)
- [Speed Dial](#)
- [Auto Answer](#)
- [Auto Intercom](#)
- [Base Restart](#)
- [Base PIN](#)
- [Base Reset](#)
- [Auto Provision](#)
- [Eco Mode+](#)
- [Eco Mode](#)
- [Repeater Mode](#)





If you require additional information or assistance with your new phone, contact your system

administrator.

Handset Name

The handset will be assigned a name by default if successfully registered to the base station. You can personalize the handset name.

To rename the handset via the handset:



1. Press  to enter the main menu.
2. Select **Settings->Handset Name**.
3. Edit the current name in the **Rename** field.
You can press  to enter special characters and press  to switch among input modes.
4. Press the **Save** soft key to accept the change or  to cancel.

Handset name is also configurable via web user interface at the path: **Account->Handset Name**.

Language

The handset supports displaying text in 12 languages: English, French, German, Italian, Polish, Portuguese, Spanish, Turkish, Czech, Swedish, Hebrew and Russian. The default language of the handset is English. You can change the language according to your requirement.

To change the language of the handset:

1. Press  to enter the main menu.
2. Select **Settings->Language**.
3. Press  or  to highlight the desired language and then press the **Select** soft key.
The LCD screen prompts "Change phone language to xxx?" (xxx is the language you selected).
4. Press the **Yes** soft key to accept the change.

Text displayed on the handset will change to the selected language.

The web user interface supports displaying text in 9 languages: English, French, German, Italian, Polish, Portuguese, Spanish, Turkish and Russian. The default language is English.

To change the language for the web user interface:

1. Select the desired language from the pull-down list at the top-right corner of web user interface.

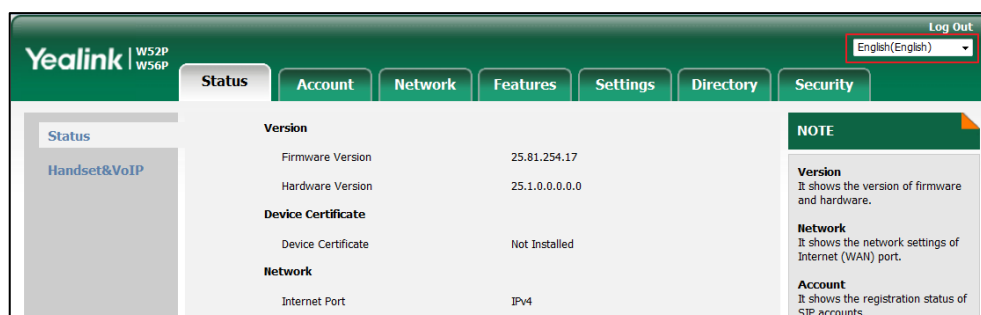

Text displayed on the web user interface will change to the selected language.

Ring Tones

Ring tones are used to indicate incoming calls. You can distinguish between an internal and external call by the ring tone. When receiving an incoming call, the handset rings the specified ring tone.

To configure ring tones via the handset:

1. Press to enter the main menu.
2. Select **Settings**->**Audio**->**Ring Tones**->**Melodies**.
3. Press or to highlight the **Intercom Call** option or the desired line.
4. Press or to select and listen to the desired ring tone.
5. Press the **Save** soft key to accept the change or the **Back** soft key to cancel.



Advisory Tones

Advisory tones are acoustic signals of your handset, which inform you of different actions and states. The following advisory tones can be configured independently of each other:

- **Keypad Tone:** plays when you press any key of the keypad.
- **Confirmation:** plays when you save settings or place the handset in the charger cradle.
- **Low Battery:** plays when the capacity of the battery is low and the handset requires charging.

To configure advisory tones via the handset:

1. Press to enter the main menu.
2. Select **Settings**->**Audio**->**Advisory Tones**.
3. Press or to select the desired value from the **Keypad Tone** field.
4. Press or to select the desired value from the **Confirmation** field.

5. Press  or  to select the desired value from the **Low Battery** field.
6. Press the **Save** soft key to accept the change or the **Back** soft key to cancel.





Note

If the silent mode is activated, the advisory tones will not play, but you can still see the low battery and confirm information alert on the LCD screen. For more information on the silent mode, refer to [Switching Silent Mode to On/Off](#) on page 26.

Backlight

Handset backlight status in the charging state or out of the charging state can be configured independently of each other. If enabled, the backlight is always on. Otherwise, the backlight is turned off after the handset is idle for a period of time. But the backlight is automatically turned on when an incoming call arrives, a key is pressed or the status of handset changes. You can disable the backlight to save power.

To configure the backlight via the handset:

1. Press  to enter the main menu.
2. Select **Settings->Display->Display Backlight**.
3. Press  or  to select the desired value from the **In Charger** field.
4. Press  or  to select the desired value from the **Out Of Charger** field.
5. Press the **Save** soft key to accept the change or the **Back** soft key to cancel.

Screen Saver

The screen saver of the handset is designed to protect your LCD screen by filling it with an analog clock. You can enable the screen saver to protect the LCD screen if you do not use your handset for a long time. When the screen saver is enabled, an analog clock will be activated and appear on the LCD screen if the handset is idle for approximately 10 seconds.

To configure screen saver via the handset:

1. Press  to enter the main menu.
2. Select **Settings->Display->Screen Saver**.
3. Press the **Change** soft key to check or uncheck the **Screen Saver** checkbox.

Color Schemes

You can change the background of your handset by changing the color theme. There are 2 color themes available.

To change the color schemes via the handset:

1. Press  to enter the main menu.

2. Select **Settings->Display->Color Schemes**.
3. Press or to highlight the desired color scheme and preview its effect.
4. Press the **Select** soft key to mark the radio box of the highlighted color theme.
The color theme of the handset is changed accordingly.

Keypad Light

You can enable the keypad light to make the keypad light up when any key is pressed. This helps you distinguish keys from each other in a dark environment.

To configure keypad light via the handset:

1. Press to enter the main menu.
2. Select **Settings->Display->Keypad Light**.
3. Press the **Change** soft key to check or uncheck the **Keypad Light** checkbox.

Notification Light

Notification light is used to indicate voice mails and missed calls. When the handset receives a voice mail or misses a call, the message key LED flashes red. You can configure the notification light to indicate the voice mails or missed calls respectively.

To configure notification light via the handset:

1. Press to enter the main menu.
2. Select **Menu->Display->Notification Light**.
3. Press or to select the desired value from the **Voice Mail** field.
If **Enabled** is selected, the message key LED flashes red when the handset receives a voice mail.
If **Disabled** is selected, the message key LED will not flash when the handset receives a voice mail.
4. Press or to select the desired value from the **Missed Call** field.
If **Enabled** is selected, the message key LED flashes red when the handset misses a call.
If **Disabled** is selected, the message key LED will not flash when the handset misses a call.
5. Press the **Save** soft key to accept the change or the **Back** soft key to cancel.

Note

When you press the Message key to view the missed calls or the received messages, the message key LED will go out.

Date and Time

Date and time are displayed on the idle screen of your handset. The handset obtains the date

and time from the Simple Network Time Protocol (SNTP) server by default. If your handset cannot obtain the date and time from the SNTP server, you need to configure the date and time manually.

To configure date and time manually for all handsets via web user interface.

1. Click on **Settings->Time & Date**.
2. Select **Enabled** from the pull-down list of **Manual Time**.
3. Enter the time and date in the corresponding fields.

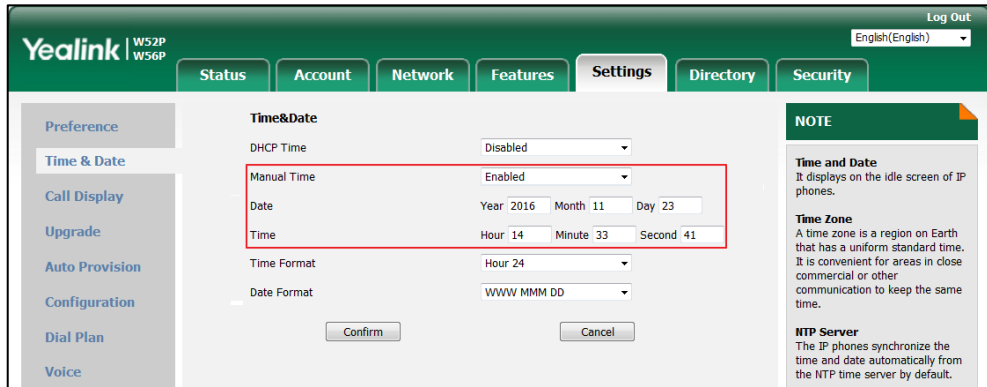

4. Click **Confirm** to accept the change.

To configure date and time manually for a specific handset:

1. Press **OK** to enter the main menu.
2. Select **Settings->Date & Time**.
3. Edit the desired value in the **Date** and **Time** field respectively.
4. Press the **Save** soft key to accept the change.

The date and time displayed on the LCD screen will change accordingly.

Note

Before you configure date and time manually for a specific handset, you should enable the **Manual Time** via web user interface first, or it would not take effect.

You can configure the time format and date format respectively. The handset supports two time formats (**12 Hour** or **24 Hour**) and seven date formats. The available date formats are listed in the following table:

Date Format	Example (2016-12-02)
WWW MMM DD	Fri. Dec 02
DD-MMM-YY	02-Dec-16
YYYY-MM-DD	2016-12-02
DD/MM/YYYY	02/12/2016
MM/DD/YY	12/02/16

Date Format	Example (2016-12-02)
DD MMM YYYY	02 Dec 2016
WWW DD MMM	Fri. 02 Dec

To configure the time format for a specific handset:

1. Press to enter the main menu.
2. Select **Settings->Display->Time Format**.
3. Press or to highlight the desired time format.
4. Press the **Change** soft key.

The radio box of the highlighted time format is marked.

The time format displayed on the LCD screen will be changed accordingly.

To configure the date format for a specific handset:

1. Press to enter the main menu.
2. Select **Settings->Display->Date Format**.
3. Press or to highlight the desired date format.
4. Press the **Change** soft key.

The radio box of the selected date format is marked.

The date format displayed on the LCD screen will be changed accordingly.

Date and time format for all handsets are configurable via web user interface at the path:

Settings->Time & Date.

For the list of available time zones on the IP phone, please refer to [Appendix A - Time Zones](#) on page 95.

To configure the DST automatically via web user interface:

1. Click on **Settings->Time & Date**.
2. Mark the **Automatic** radio box in the **Daylight Saving Time** field.
3. Select the desired time zone from the pull-down list of **Time Zone**.
4. Select the desired time zone name from the pull-down list of **Location**.

The pull-down list of **Location** displays the corresponding time zone names for the time zone you selected.

If the selected location uses daylight saving time, the **Start Date**, **End Date** and **Offset(minutes)** fields will be filled with time automatically. All of them are read-only.

The screenshot shows the 'Time & Date' configuration page in the Yealink W52P/W56P web interface. The page is divided into a left sidebar with navigation options (Preference, Time & Date, Call Display, Upgrade, Auto Provision, Configuration, Dial Plan, Voice, Tones, TR069, Voice Monitoring, SIP) and a main content area. The 'Time & Date' section is active, showing various settings. A red box highlights the 'Time Zone', 'Daylight Saving Time', and 'Fixed Type' fields. The 'Time Zone' is set to '+8 China, Singapore, Australia, Russia'. 'Daylight Saving Time' is set to 'Automatic'. 'Fixed Type' is set to 'DST by Date'. The 'Start Date', 'End Date', and 'Offset(minutes)' fields are populated with values. A 'NOTE' section on the right explains the 'Time and Date' field and provides details about 'Time Zone' and 'Daylight Saving Time'.

5. Click **Confirm** to save the change.

The phone will use the daylight saving time of the selected location.

Note

If the location you select does not use daylight saving time, the fields of Start Date, End Date and Offset will be left blank.

To configure the DST manually via web user interface:

1. Click on **Settings->Time & Date**.
2. Select the desired time zone from the pull-down list of **Time Zone**.
3. Mark the **Enabled** radio box in the **Daylight Saving Time** field.
4. Do one of the following:
 - Mark the radio box of **DST by Date** in the **Fixed Type** field.

Enter the start date and end date in the corresponding fields.

The screenshot shows the 'Time & Date' configuration page in the Yealink web interface. The 'Fixed Type' field is set to 'DST by Date'. The 'Start Date' and 'End Date' fields are highlighted with a red box. The 'Start Date' is set to Month 10, Day 6, Hour 2, and the 'End Date' is set to Month 4, Day 6, Hour 2. The 'Daylight Saving Time' field is set to 'Enabled'.

- Mark the radio box of **DST by Week** in the **Fixed Type** field.
Select the desired date from the pull-down lists of **Start Date** and **End Date**.

The screenshot shows the 'Time & Date' configuration page in the Yealink web interface. The 'Fixed Type' field is set to 'DST by Week'. The 'Start Date' and 'End Date' fields are highlighted with a red box. The 'Start Date' is set to January, First In Moi, Sunday, 00:00, and the 'End Date' is set to January, First In Moi, Sunday, 00:00. The 'Daylight Saving Time' field is set to 'Enabled'.

5. Enter the offset time (in minutes) in the **Offset(minutes)** field.
6. Click **Confirm** to save the change.

Note



Please refer to [Appendix A - Time Zones](#) for the list of available time zones on the IP phone.

To disable the DST via web user interface:

1. Click on **Settings->Time & Date**.
2. Mark the **Disabled** radio box in the **Daylight Saving Time** field.

3. Click **Confirm** to save the change.





Shortcuts

There are two types of shortcuts on the handset: changeable and unchangeable shortcuts. A feature is pre-assigned to each shortcut. For example, long press  to turn on/off the silent mode, long press  to lock/unlock the keypad, press  to access the directory and so on.





The changeable shortcuts are the two soft keys and four navigation keys. The available features that can be assigned to each key may vary.

You can assign the frequently used features to the changeable shortcuts of your handset. This helps you get quick access to a feature by pressing the corresponding shortcut directly without having to scroll through the menu when the handset is idle.

The default shortcut key feature:

Shortcut key	Default access features
Left soft key	History
Right soft key	Line Status
	Intercom
	Directory
	Volume-
	Volume+

To configure a shortcut via the handset:

1. Press  to enter the main menu.
2. Select **Settings->Shortcut**.
The LCD screen displays the changeable shortcuts with features currently assigned to them.
3. Press  or  to highlight the desired shortcut.
4. Press the **Change** soft key to access the available features.
The feature currently assigned to the selected key is highlighted and followed by a left arrow.
5. Press  or  to highlight the desired feature.
6. Press the **OK** soft key to accept the change or the **Back** soft key to cancel.

Contact Management

This section provides operating instructions on how to manage contacts. Topics include:

- [Local Directory](#)
- [Blacklist](#)
- [Remote Phone Book](#)

Local Directory

You can store the frequently used contacts in the handset's local directory, where names and numbers can be freely added, deleted and edited. You can store up to 100 contacts per handset, each with a name, a mobile number and an office number. You can also dial a contact from the local directory. This allows you to place calls without having to dial the number manually.







Adding Contacts

You can add contacts to your local directory manually or from the call history. You can also add contacts to your local directory from the remote phone book. For more information, refer to [Remote Phone Book](#) on page 42.

To add a contact to the local directory manually via the handset:

1. Press  to enter the main menu.
2. Select **Directory**.
3. Press the **Options** soft key, and then select **New Contact**.
If there is no contact in the local directory, press the **New** soft key directly.
4. Enter the desired value in the **Name**, **Number** and **Mobile** field respectively.
5. Press the **Save** soft key to accept the change or the **Back** soft key to cancel.

To add a contact to the local directory from the call history via the handset:

1. Press the **History** soft key when the handset is idle.
2. Press  or  to select **All Calls**, **Missed Calls**, **Placed Calls** or **Received Calls**.
3. Press  or  to highlight the desired entry.
4. Press the **Options** soft key, and then select **Add To Local**->**New Entry**.
You can also select **Update Existing** to add the number to an existing contact.
5. Press  or  to set the number to be the office number or the mobile number, and then press the **OK** soft key.
6. Enter the name of the new entry in the **Name** field.

7. Press the **Save** soft key to accept the change or the **Back** soft key to cancel.



Note

When you add a contact, the name is required, the office number and the mobile number cannot be left blank at the same time.

If the information of the contact you want to add is totally same with that of an existing entry in the local directory, the screen will prompt "Contact already exists. Please input others name or update contact".

Editing Contacts



To edit a contact in the local directory via the handset:

1. Press  to enter the main menu.
2. Select **Directory**.
3. Press  or  to highlight the desired entry.
4. Press the **Options** soft key, and then select **Edit**.
5. Edit the value in the **Name**, **Number** and **Mobile** field respectively.
6. Press the **Save** soft key to accept the change.

Deleting Contacts

You can delete a contact or all contacts from the local directory.

To delete a contact via the handset:

1. Press  to enter the main menu.
2. Select **Directory**.
3. Press  or  to highlight the desired entry.
4. Press the **Options** soft key, and then select **Delete**.
The LCD screen prompts "Do you want to delete the selected item?".
5. Press the **Yes** soft key to delete or the **No** soft key to cancel.

To delete all contacts via the handset:

1. Press  to enter the main menu.
2. Select **Directory**.
3. Press the **Options** soft key, and then select **Delete All**.
The LCD screen prompts "Delete All?".
4. Press the **Yes** soft key to delete all contacts or the **No** soft key to cancel.

Searching for Contacts









You can search for the contacts by simply entering a few continuous characters of the desired contact name or number, and the results of potential matches are dynamically filtered and displayed on the LCD screen.

To search for contacts in the local directory via the handset:

1. Press  to enter the main menu.
2. Select **Directory**.
3. Enter a few continuous characters of the desired contact name or number using the keypad.
The contact whose name or number matches the search will appear on the LCD screen after a timeout. You can dial a contact from the result list.

Placing a Call from Local Directory

To place a call from the local directory via the handset:

1. Press  to enter the main menu.
2. Select **Directory**.
3. Press  or  to highlight the desired entry.
4. Do one of the following:
 - Press  , if only one number is stored for the contact in the local directory, the phone will dial out the number directly.
 - Press  , if both the office number and the mobile number are stored for the contact in the local directory, the screen will display two numbers.
Press  or  to highlight the desired number.
Press  to dial out.

Blacklist

You can store up to 30 contacts in one handset's blacklist. You can add, edit or delete contacts in the blacklist. You can also dial a call from the blacklist, but an incoming call from a contact in the blacklist will be rejected automatically.

To add an entry to the blacklist manually via the handset:

1. Press  to enter the main menu.
2. Press **Settings->Telephony->Caller Blacklist**.
3. Press the **Options** soft key, and then select **New Entry**.
If there is no entry, press the **OK** soft key directly.
4. Enter the desired number in the **Phone Number** field.
5. Press the **Save** soft key to accept the change or the **Back** soft key to cancel.

You can also add an entry to the blacklist from the call history. For more information, refer to [Call History Management](#) on page 44.

To delete an entry from the blacklist via the handset:

1. Press  to enter the main menu.

2. Select **Settings->Telephony->Caller Blacklist**.
3. Press or to highlight the desired entry.
4. Press the **Options** soft key, and then select **Delete**.

The selected entry will be deleted successfully.

To delete all entries from the blacklist via the handset:

1. Press to enter the main menu.
2. Select **Settings->Telephony->Caller Blacklist**.
3. Press the **Options** soft key, and then select **Delete All**.
The LCD screen prompts "Delete All?".
4. Press the **Yes** soft key to delete all entries or the **No** soft key to cancel.

To place a call from the blacklist via the handset:

1. Press to enter the main menu.
2. Select **Settings->Telephony->Caller Blacklist**.
3. Press or to highlight the desired entry.
4. Press to dial out.

Remote Phone Book

You can access your remote phone book on your handset. You can add contacts to the local directory from the remote phone book. You can also dial a contact from the remote phone book. Contact your system administrator for the access URL of the remote phone book.

To configure the access URL of the remote phone book via web user interface:

1. Click on **Directory->Remote Phone Book**.
2. Enter the access URL in the **Remote URL** field.
3. Enter the name in the **Display Name** field.

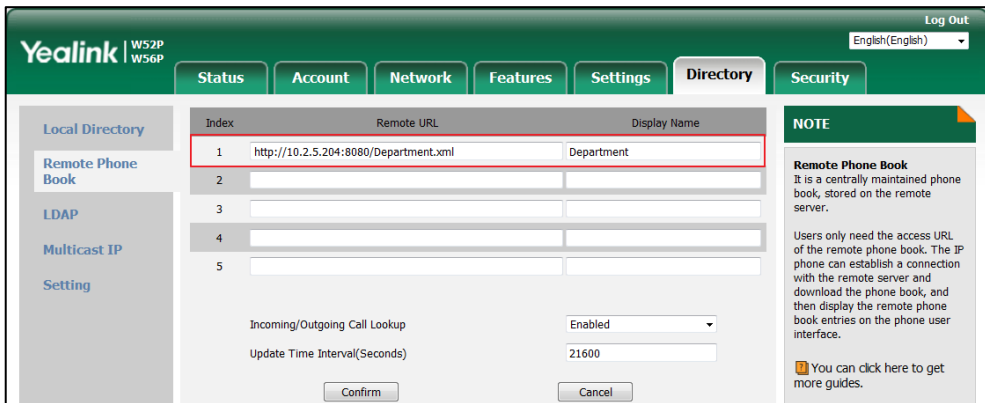

- Click **Confirm** to accept the change.

Note

All the handsets that are registered to the base station can access to the remote phone book.

You can enable the handset to present the caller/callee identity stored in the remote phone book when receiving/placing a call.

To configure incoming/outgoing call lookup and update time interval via web user interface:

- Click on **Directory->Remote Phone Book**.
- Select **Enabled** from the pull-down list of **Incoming/Outgoing Call Lookup**.
- Enter the desired refresh period in the **Update Time Interval(Seconds)** field.

The default value is 21600 seconds.

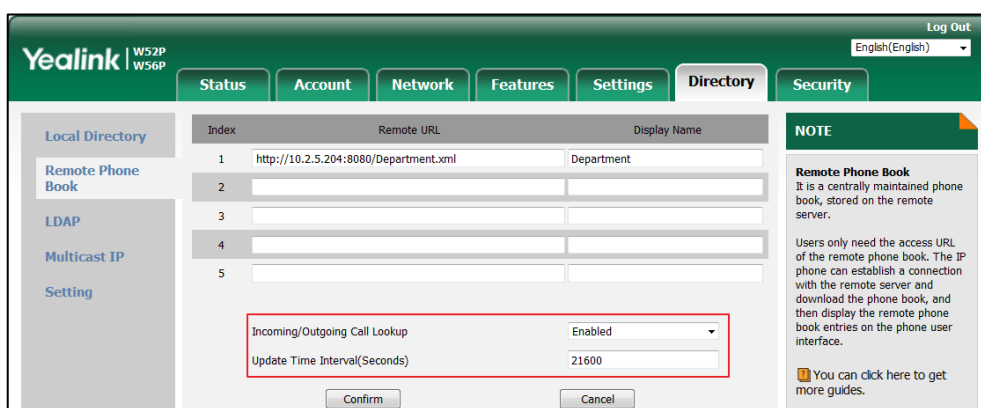

- Click **Confirm** to accept the change.

To access your remote phone book via the handset:

- Press **OK** to enter the main menu.
- Select **Directory**.
- Press **▲** or **▼** to highlight the desired remote phone book, and then press the **Enter** soft key.





The handset connects to the remote phone book and proceeds to load it. The contacts in the remote phone book are displayed on the LCD screen.

To place a call from the remote phone book:



- Press **OK** to enter the main menu.
- Select **Directory**.
- Press **▲** or **▼** to highlight the desired remote phone book, and then press the **Enter** soft key.

The handset connects to the remote phone book and proceeds to load it. The contacts in the remote phone book are displayed on the LCD screen.

- Select the desired contact from the remote phone book.

5. Do one of the following:
 - Press , if only one number is stored for the contact in the remote phone book, the phone will dial out directly.
 - Press , if both the office number and the mobile number are stored for the contact in the remote phone book, the screen will display two numbers.
 - Press  or  to highlight the desired number.
Press  to dial out.

To add a contact to the local directory from the remote phone book via the handset:

1. Press  to enter the main menu.
2. Select **Directory**.
3. Press  or  to highlight the desired remote phone book, and then press the **Enter** soft key.





The handset connects to the remote phone book and proceeds to load it. The contacts in the remote phone book are displayed on the LCD screen.
4. Select the desired contact from the remote phone book.
5. Press the **Options** soft key, and then select **Add To Local->New Entry**.
You can also select **Update Existing** add the number to an existing contact.
6. Press the **Save** soft key to add the contact to the local directory.

Call History Management

Call history contains call information such as calling/called party identification, time and date, and call duration. The handset maintains call history lists of All Calls, Missed Calls, Placed Calls and Received Calls. Each call history list supports up to 100 entries and is sorted by date and time of the call, starting with the latest call entry, the earliest entry would not maintain when the list is up to 100.

You can check the detailed information of an entry in the call history. If the name and number of calling/called party is in the directory, the list displays the calling/called party name (matching priority: Local Directory>Remote Phone Book), or it will display the number instead. You can also dial a call, add an entry to the local directory or blacklist, or delete entries from the call history.





To view call history via the handset:

1. Press the **History** soft key when the handset is idle.
2. Press  or  to select **All Calls, Missed Calls, Placed Calls** or **Received Calls**.
3. Press  or  to highlight the desired entry.
4. Press the **Options** soft key, and then select **Detail**.





The LCD screen displays the details of the entry.

You can block the incoming calls from the entry by adding it to the blacklist. For more information, refer to [Blacklist](#) on page 41.



To add an entry to the blacklist from the call history via the handset:

1. Press the **History** soft key when the handset is idle.
2. Press  or  to select **All Calls, Missed Calls, Placed Calls** or **Received Calls**.
3. Press  or  to highlight the desired entry.
4. Press the **Options** soft key, and then select **Add To Blacklist**.
The LCD screen prompts "Are you sure?".
5. Press the **Yes** soft key to add the selected entry to the blacklist or the **No** soft key to cancel.





To delete an entry from the call history via the handset:

1. Press the **History** soft key when the handset is idle.
2. Press  or  to select **All Calls, Missed Calls, Placed Calls** and **Received Calls**.
3. Press  or  to highlight the desired entry.
4. Press the **Options** soft key, and then select **Delete**.
The selected entry is deleted successfully.

To delete all entries of a list from the call history via the handset:

1. Press the **History** soft key when the handset is idle.
2. Press  or  to select **All Calls, Missed Calls, Placed Calls** or **Received Calls**.
3. Press the **Options** soft key, and then select **Delete All**.
The LCD screen prompts "Delete All?".
4. Press the **Yes** soft key to delete all entries of the selected list or the **No** soft key to cancel.

To place a call from the call history via the handset:

1. Press the **History** soft key when the handset is idle.
2. Press  or  to select **All Calls, Missed Calls, Placed Calls** and **Received Calls**.
3. Press  or  to highlight the desired entry.
4. Press  to dial out.

Dial Plan

Dial plan is a string of characters that governs the way your handset processes the inputs received from your handset keypad. The handset supports the following dial plan features:

- [Replace Rule](#)
- [Area Code](#)
- [Block Out](#)

Basic expression syntaxes you need to know:

.	The dot "." can be used as a placeholder or multiple placeholders for any character. Example: "12." would match "123", "1234", "12345", "12abc", etc.
x	An "x" can be used as a placeholder for any character. Example: "12x" would match "121", "122", "123", "12a", etc.
-	Numeric ranges are allowed within the brackets: Digit "-" Digit. Example: "[5-7]" would match the number "5", "6" or "7".
[]	The square brackets "[]" can be used as a placeholder for a single character which matches any of a set of characters. Example: "91[5-7]1234" would match "9151234", "9161234", "9171234", etc.
()	The parentheses "()" can be used to group together patterns, for instance, to logically combine two or more patterns. Example: "91([5-7])1(x)" would match "91511", "91618", "91715", etc.
\$	The "\$" followed by the sequence number of a parenthesis means the characters placed in the parenthesis. The sequence number stands for the corresponding parenthesis. Example: A replace rule configuration, Prefix: "001(XXX)45(XX)", Replace: "9001\$145\$2". When you dial out "0012354599" on your phone, the IP phone will replace the number with "90012354599". "\$1" means 3 digits in the first parenthesis, that is, "235". "\$2" means 2 digits in the second parenthesis, that is, "99".

Note

The IP phone supports a new dial plan mechanism - digit map. Digit maps are defined by a single string or a list of strings. If a number you dial matches any string of a digit map, the call is automatically placed.

Note that if digit map feature is enabled, the old dial plan rules (describe in this chapter) will be ignored. For more information, contact your system administrator.

Replace Rule

You can configure one or more replace rules (up to 100) to remove the specified string and replace it with another string. You can configure a pattern with wildcards (refer to the expression syntax in the table above), so that any string that matches the pattern will be replaced. This feature is convenient for you to dial out a long number. For example, a replace rule is configured as "Prefix: 1" and "Replace: 104", when you want to dial out the number "104", you just need to enter "1" on the handset and then dial out.

To add a replace rule via web user interface:

1. Click on **Settings->Dial Plan->Replace Rule**.
2. Enter the string (e.g., 1) in the **Prefix** field.
3. Enter the string (e.g., 104) in the **Replace** field.

- Enter the desired line ID in the **Account** field or leave it blank.

The screenshot shows the 'Replace Rule' configuration page in the Yealink web interface. The page includes a sidebar with navigation options like 'Preference', 'Time & Date', 'Call Display', 'Upgrade', 'Auto Provision', 'Configuration', 'Dial Plan', 'Voice', 'Tones', 'TR069', 'Voice Monitoring', and 'SIP'. The main content area has a table with the following structure:

Index	Prefix	Replace	Account
1			<input type="checkbox"/>
2			<input type="checkbox"/>
3			<input type="checkbox"/>
4			<input type="checkbox"/>
5			<input type="checkbox"/>
6			<input type="checkbox"/>
7			<input type="checkbox"/>
8			<input type="checkbox"/>
9			<input type="checkbox"/>
10			<input type="checkbox"/>

Below the table, there are input fields for 'Prefix: 1', 'Replace: 104', and 'Account'. There are 'Add', 'Edit', and 'Del' buttons at the bottom. A 'NOTE' section on the right explains the fields and provides a legend for special characters.

- Click **Add** to add the replace rule.

When you enter the number "1" using the keypad and then dial out using the configured account, the handset will dial out "104" instead.

Note

The valid value of the "Account" parameter can be one or more digits among 1, 2, 3, 4 and 5, each of which represents a line ID. Multiple digits must be separated by commas. For example, when you enter the value "1, 2" in the **Account** field, this dial plan rule will apply to account1 and account2.

If you leave the **Account** field blank or enter 0, this dial plan rule will apply to all accounts.

To edit a replace rule via web user interface:

- Click on **Settings->Dial Plan->Replace Rule**.
- Select the desired replace rule by clicking the replace rule or checking the check box.
- Edit the value in the **Prefix** and **Replace** field respectively.
- Enter the desired line ID in the **Account** field or leave it blank.
- Click **Edit** to accept the change.

To delete one or more replace rules via web user interface:

- Click on **Settings->Dial Plan->Replace Rule**.
- Select one or more replace rules by clicking the replace rule(s) or checking the check box(es).
- Click **Delete** to delete the replace rule(s).

Note

Replace rule is configurable via web user interface only.

Replace rule is applicable to all the handsets registered to the base station.

Area Code

Area codes are also known as Numbering Plan Areas (NPAs). They usually indicate geographical areas in a country. This feature is necessary only when dialing the number outside the code area. For example, area code is configured as "Code: 011, Minimum Length: 4, Maximum Length: 11", then when you dial out the number "56789", which has digits between 4 and 11, the phone will add the area code before the number and dial out (01156789).

To configure area code via web user interface via the handset:

1. Click on **Settings->Dial Plan->Area Code**.
2. Enter the desired value in the **Code**, **Minimum Length (1-15)** and **Maximum Length (1-15)** field respectively.
3. Enter the desired line ID in the **Account** field or leave it blank.

For more information on the valid values for the **Account** field, refer to Replace Rule on page 46.

4. Click **Confirm** to accept the change.

Note

The default values of minimum and maximum lengths are 1 and 15.
Area code is configurable via web user interface only.
Area code is applicable to all the handsets registered to the base station.

Block Out

You can block some specific numbers (up to 10) from being dialed. When you dial the block out number on the handset, the dialing will fail, and the LCD screen will prompt "Forbidden".

To add a block out number via web user interface via the handset:

1. Click on **Settings->Dial Plan->Block Out**.
2. Enter the desired value in the **BlockOut NumberX** field.
3. Enter the desired line ID in the **Account** field or leave it blank.

For more information on the valid values for the **Account** field, refer to Replace Rule on page 46.

BlockOut Number	Account
BlockOut Number1	Account
BlockOut Number2	Account
BlockOut Number3	Account
BlockOut Number4	Account
BlockOut Number5	Account
BlockOut Number6	Account
BlockOut Number7	Account
BlockOut Number8	Account
BlockOut Number9	Account
BlockOut Number10	Account

- Click **Confirm** to add the block out number.

Note

Block out is configurable via web user interface only.
Block out is applicable to all the handsets registered to the base station.

Emergency Numbers

Public telephone networks in countries around the world have a single emergency telephone number (emergency services number), that allows a caller to contact local emergency services for assistance when necessary. The emergency telephone number may differ from country to country. It is typically a three-digit number so that it can be easily remembered and dialed quickly. Some countries have different emergency numbers for different emergency services.

You can specify the emergency numbers for contacting the emergency services in an emergency situation. You can dial these numbers when the phone is locked. For more information on phone lock, refer to [Locking/Unlocking Keypad](#) on page 25.

Note

Contact your local phone service provider for available emergency numbers in your area.
The IP phone also supports the emergency dialplan, which allows users to make emergency calls if the phone is locked or unregistered. For more information, contact your system administrator.

To specify emergency numbers via web user interface:

- Click on **Features->Phone Lock**.
- Enter the emergency services number in the **Emergency** field.

For multiple numbers, enter a comma between every two emergency numbers. The default emergency numbers are 112, 911 and 110.

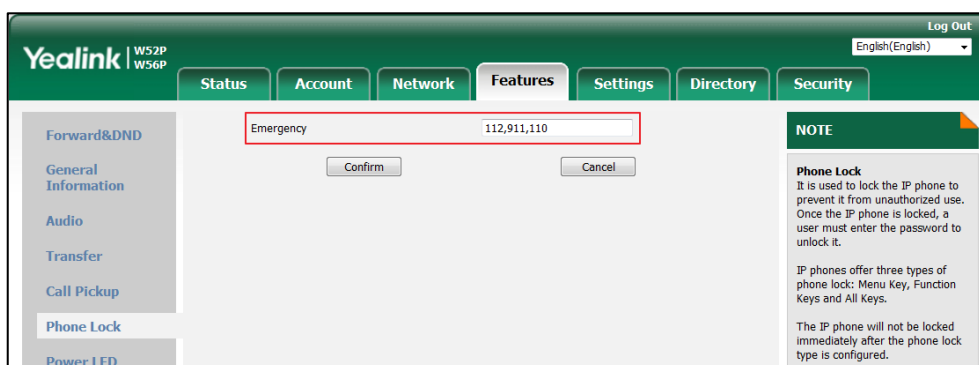

3. Click **Confirm** to accept the change.
Then you can dial the emergency numbers when the keypad is locked.

Outgoing Lines

After the handset is registered to the base station (refer to [Handset Registration](#)), you can assign one or more outgoing lines for the handset. The handset can only use the assigned outgoing line(s) to place calls. When multiple outgoing lines are assigned to the handset, the handset uses the first line as the default outgoing line. You can change the default outgoing line of the handset.

To assign the outgoing line to specific handset via web user interface:

1. Click on **Account->Number Assignment**.
2. Check the desired checkbox of the account from **Line No.&Name** field for the corresponding handset in the **Handset No.** field.

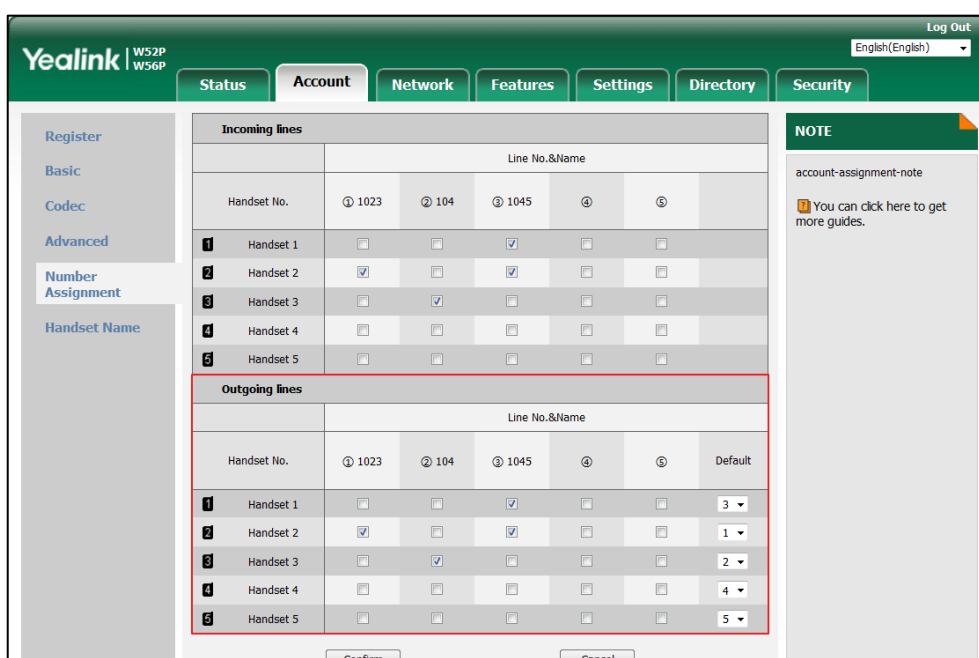



3. (Optional.) Select the default outgoing line from the **Default** field. The default outgoing line is the first line you selected. You can only select the line number you have checked for the handset, or it will not take effect.
4. Click **Confirm** to save the change.

As the configuration shown above, you can do the following:

- For Handset1: Line 3 (1045) is assigned to Handset1, and it is the default outgoing line. You can only place a call using line 3 (1045).
- For Handset2: Line 1 (1023) and line 3 (1045) are assigned to Handset2, and the default outgoing line is line1. You can place a call using line 1 (1023) or line 3 (1045).
- For Handset3: Line 2 (104) is assigned to Handset3, and it is the default outgoing line. You can only place a call using line 2 (104).
- Both Handset 1 and Handset 2 can place a call using the line 3 (1045) at the same time.

To change the default outgoing line via the handset:

1. Press  to enter the main menu.
2. Select **Settings->Telephony->Default Line**.
The LCD screen displays all outgoing lines currently assigned to the handset. The default outgoing line is highlighted and followed by a left arrow.
3. Press  or  to highlight the desired line, and then press the **OK** soft key.
The default outgoing line is changed successfully.

Incoming Lines

After the handset is registered to the base station (refer to [Handset Registration](#)), you can assign one or more incoming lines for the handset. The handset can only receive incoming calls of the assigned incoming line(s). You can assign incoming lines to all handsets registered to the same base station on your handset.

To assign the incoming line to handset via web user interface:

1. Click on **Account->Number Assignment**.
2. Check the desired checkbox of the account from **Line No.&Name** field for the corresponding handset in the **Handset No.** field.

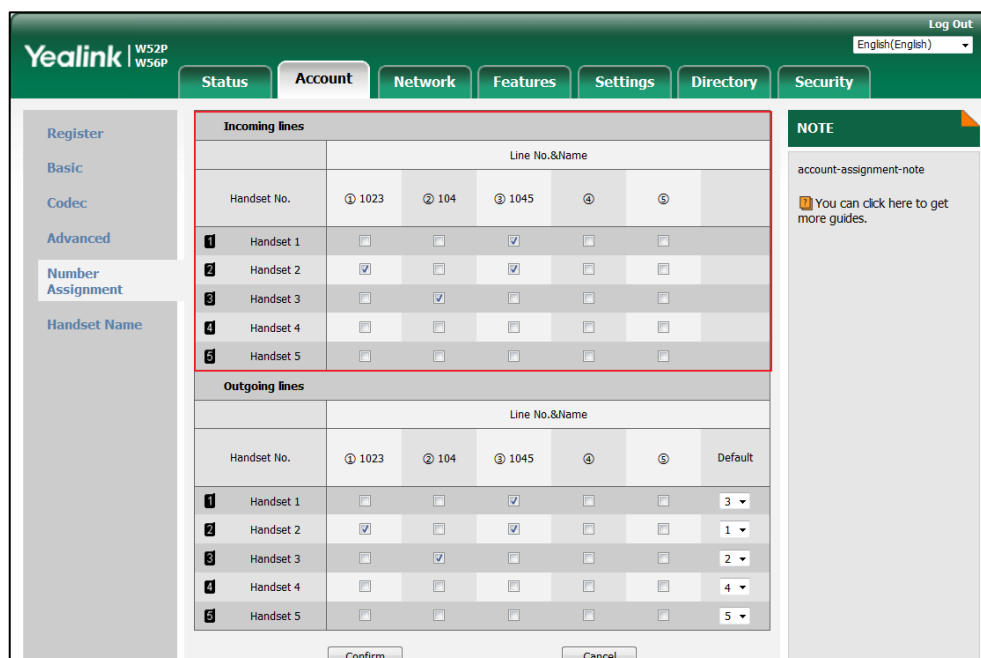

3. Click **Confirm** to save the change.

As the configuration shown above, you can do the following:

- For Line 1: Line 1 (1023) is assigned to Handset2. A call to line 1 (1023) will be received by Handset2.
- For Line 2: Line 2 (104) is assigned to Handset3. A call to line 2 (104) will be received by Handset3.
- For Line 3: Line 3 (1045) is assigned to Handset1 and Handset2. A call to line 3 (1045) will be received by Handset1 and Handset2 at the same time. The handsets ringing simultaneously, the incoming call can be only answered by one of them.

To assign the incoming line to handsets via the handset:

1. Press **OK** to enter the main menu.
2. Select **Settings->Telephony->Incoming Lines**.
3. Enter the system PIN (default: 0000), and then press the **Done** soft key.

The LCD screen displays all handsets registered to the base station. The handset itself is highlighted and followed by a left arrow.

4. Press **▲** or **▼** to highlight the desired handset, and then press the **OK** soft key.
5. Press **←** or **→** to select **Accept** from the desired line fields.
6. Press the **Save** soft key to accept the change.

7. Press the **Back** soft key to return to the previous screen.
8. Repeat steps 4-7 to assign incoming lines for other handsets.

Key As Send

You can set the “#” key or “*” key to perform as a send key while dialing.

To configure key as send via web user interface:

1. Click on **Features->General Information**.
2. Select the desired value from the pull-down list of **Key As Send**.

The screenshot shows the Yealink W52P/W56P web interface. The 'Features' tab is selected, and the 'General Information' section is active. The 'Key As Send' setting is highlighted with a red box and is set to '#'. Other settings include Call Waiting (Enabled), Reserve # in User Name (Enabled), Busy Tone Delay (0), Return Code When Refuse (486 (Busy Here)), Return Code When DND (480 (Temporarily Unavailable)), Feature Key Synchronization (Disabled), and Time Out for Dial Now Rule (1). A 'NOTE' section on the right explains the 'Key As Send' feature: 'Assigns “#” or “*” as the send key.'

3. Click **Confirm** to accept the change.

Speed Dial

Speed dial allows you to perform single-digit dialing to predefined numbers. This feature is particularly useful to speed up dialing the numbers that is frequently used or hard to remember. A maximum of 8 speed dial numbers are allowed.

For example, the digit key 2 is configured as a speed dial key and assigned the number 4606, the phone will dial out the number 4606 directly when you long press digit key 2.







Assigning a Speed Dial Number

You can assign a number in your directory (including local directory and remote phone book) to the digit keys of your handset. This helps you dial a contact quickly and easily by long pressing the speed dial key without having to enter the directory. The available speed dial keys are the digit keys 2-9.

Note



The assigned number should exist in local directory (refer to [Local Directory](#) on page 39) or remote phone book (refer to [Remote Phone Book](#) on page 42).

To assign a speed dial number from the directory via the handset:

1. Press  to enter the main menu.
2. Select **Settings->Telephony->Speed Dial**.
The LCD screen displays all available speed dial keys.
If the digit key did not be assigned numbers before, you can long press the digit key when the phone is idle to enter the Add to speed dial screen.
3. Press  or  to highlight the desired digit key, and then press the **Assign** soft key.
4. Press  or  to highlight the desired directory if there are multiple directories, and then press the **Enter** soft key.
5. Select the desired contact from the directory.
6. Do one of the following:
 - If only one number is stored for the contact in the selected directory, press the **OK** soft key to assign the number to the selected speed dial key.
 - If both the office number and the mobile number are stored for the contact in the selected directory, press the **OK** soft key to display the two numbers.
Press  or  to highlight the desired number.
Press the **OK** soft key to assign the number to the selected speed dial key.



Changing a Speed Dial Number

To change a speed dial number via the handset:

1. Press  to enter the main menu.
2. Select **Settings->Telephony->Speed Dial**.
The LCD screen displays all available speed dial keys.
3. Press  or  to highlight the desired speed dial key, which is already assigned a number.
4. Press the **Change** soft key to change the assigned speed dial number.

Deleting a Speed Dial Number

To delete a speed dial number via the handset:

1. Press  to enter the main menu.
2. Select **Settings->Telephony->Speed Dial**.
The LCD screen displays all available speed dial keys.
3. Press  or  to highlight the desired speed dial key, which is already assigned a number.
4. Press the **Clear Key** soft key to delete the assigned speed dial number.

Placing a Call Using Speed Dial Key

To place a call using the speed dial key via the handset:

1. Long press the speed dial key (digit key 2-9) when the handset is idle.
The number assigned to this speed dial key is dialed out.

Auto Answer

When auto answer feature is enabled, you can simply answer the incoming calls by picking up the handset from the charger cradle without having to press the off-hook key. The auto answer feature works only if the handset is placed in the charger cradle.

To configure auto answer via the handset:

1. Press  to enter the main menu.
2. Select **Settings->Telephony->Auto Answer**.
3. Press the **Change** soft key to check or uncheck the **Auto Answer** checkbox.

Auto Intercom

Intercom is a useful feature in an office environment to quickly connect with the operator or the secretary. You can make internal intercom calls and external intercom calls on the phone. Internal intercom calls are made between handsets registered to the same base station. External intercom calls can be made by dialing the feature access code followed by the number. External intercom calls depend on support from a SIP server.



The handset can automatically answer an incoming external intercom call and play warning tone only when there is only one handset subscribed and no call in progress on the handset.

To automatically answer an incoming internal intercom call, you need to enable auto intercom feature on the handset. The following configuration types of auto intercom feature are available for selection:

- **On (Beep On):** Auto intercom feature is on. The handset will answer an incoming internal intercom call automatically and play a warning tone.
- **On (Beep Off):** Auto intercom feature is on. The handset will answer an incoming internal intercom call automatically without a warning tone.
- **Off:** Auto intercom feature is off. You need to answer an incoming internal intercom call manually.

To configure auto intercom via the handset:

1. Press  to enter the main menu.
2. Select **Settings->Telephony->Auto Intercom**.
The LCD screen displays three configuration types.

3. Press  or  to highlight the desired configuration type.
4. Press the **Change** soft key.

The radio box of the selected configuration type is marked.

For more information on placing an internal call, refer to [Placing Internal Calls](#) on page 62.

Base Restart

In some instances, you may need to restart the base station to refresh the settings.

To restart the base station via the handset:

1. Press  to enter the main menu.
2. Select **Settings->System Settings->Base Restart**.
3. Enter the system PIN (default: 0000), and then press the **Done** soft key.

After the above steps, the registration LED and network status LED go out simultaneously. After a period of time, the LED indicators will illuminate solid green again when the base station restarts successfully.

Base restart is also configurable via the web user interface at the path: **Settings->Upgrade**.

Base PIN

To avoid unauthorized register or access to some features on the handset, you should keep the base PIN secret. The default base PIN is "0000", you can change the default base PIN.

To change the base PIN via the handset:

1. Press  to enter the main menu.
2. Select **Settings->System Settings->Change Base PIN**.
3. Enter the system PIN (default: 0000), and then press the **Done** soft key.
4. Enter the new PIN in the **Enter New PIN** and **Re-enter New PIN** field respectively.
5. Press the **Save** soft key to accept the change.

Base PIN is also configurable via the web user interface at the path: **Security->Base PIN**.

Note

We recommend you to set the new PIN in random and cannot be easily guessed.

Base Reset

You can reset the base station to factory settings. This will clear all individual settings of the base station (e.g., directory and account registrations). Handset registrations and the system PIN will not be reset to factory defaults. We recommend that you ask your system administrator for advice before resetting your base station.

To reset the base station via the handset:

1. Press  to enter the main menu.
2. Select **Settings->System Settings->Base Reset**.
3. Enter the system PIN (default: 0000), and then press the **Done** soft key.
4. Highlight **Reset to factory**, and then press the **OK** soft key.

All individual settings of the base station will be reset to factory defaults. The power indicator LED and network status LED on the base station slow flash in sequence during the resetting process. Indicator LEDs on the base station illuminate solid green after startup.

Reset the base station is also configurable via the web user interface at the path:

Settings->Upgrade.

Note

Base station reset may take a few minutes. Do not power off until the base station starts up successfully.

Handset Reset

You can reset individual settings that you have made on the handset. Resetting handset will not overwrite settings of directory, call history, voice mail and the handset registration to the base station. Other customized settings on the handset will be reset to factory settings after handset reset. We recommend that you ask your system administrator for advice before resetting your handset.

To reset the handset via the handset:

1. Press  to enter the main menu.
2. Select **Settings->System Settings->Handset Reset**.
The LCD screen prompts "Reset handset to default?".
3. Press the **Yes** soft key to reset the handset or the **No** soft key to cancel.

Auto Provision

You can trigger the auto provisioning process using the wizard. After you enter the user name and password in the wizard and confirm to perform an update, the base station tries to connect the RPS (Redirection and Provisioning Service) server. If the base station successfully connects the RPS server, the RPS server will respond the base station with the URL for downloading the configuration files. Then the base station will try to perform auto provisioning. Contact your system administrator for the user name and password used to connect the RPS server.

To trigger the auto provisioning process via the handset:

1. Press  to enter the main menu.
2. Select **Settings->System Settings->Auto Provision**.

3. Enter the system PIN (default: 0000) and then press the **Done** soft key.
4. Enter the valid value in the **Username** field and then press the **OK** soft key.
5. Enter the valid value in the **Password** field and then press the **OK** soft key.
The LCD screen prompts "Update now?".
6. Press the **Yes** soft key to perform an update or the **No** soft key to cancel.

Eco Mode+

Eco mode+ turns off the transmission power and the radio waves emitted are virtually zero when the phone is in the standby mode. If the eco mode+ is enabled, and there is no signal interaction between the handset and the base station, the color of the signal strength indicator on the idle screen will display in green. When a call comes in or a connection occurs, the phone exits the eco mode+ automatically, and the signal strength indicator on the idle screen changes from green to white.

To configure eco mode+ via the handset:

1. Press to enter the main menu.
2. Select **Settings->System Settings->Eco Mode+**.
3. Press the **Change** soft key.
4. Enter the system PIN (default: 0000) and then press the **Done** soft key.
The LCD screen prompts "Setting takes effect after base reboot. Reboot now or not?".
5. Press the **Yes** soft key to reboot the base station.

The base station reboots to make the configuration take effect. The configuration applies to all the handsets registered to the base station. The color of the signal strength indicator on the idle screen will change from white to green.

Eco Mode

Eco mode greatly reduces the transmission power and signal output when the phone is in the talk mode. The attenuation range is 20m. When the distance between the base station and the handset is over 20m, the eco mode is disabled automatically.

To configure eco mode via the handset:

1. Press to enter the main menu.
2. Select **Settings->System Settings->Eco Mode**.
3. Press the **Change** soft key to check or uncheck the **Eco Mode** checkbox.
If the **Eco Mode** checkbox is checked, the eco mode is enabled.

Note

If the eco mode is enabled, the coverage area of the base station will be reduced.

Repeater Mode

Repeater mode extends the radio coverage of the base station. The repeater has the same radio coverage as the base station. This feature is especially useful for users who require mobility in large dwellings. If the repeater mode is enabled, and a repeater is registered to the base station, the handset registered to the base station can be used either in the base station or the repeater coverage area, thereby providing users with greater freedom in mobility.

To configure the repeater mode via the handset:

1. Press  to enter the main menu.
2. Select **Settings->System Settings->Repeater Mode**.
3. Press the **Change** soft key to check the **Repeater Mode** checkbox.
The LCD screen prompts "Setting takes effect after base reboot. Reboot now or not?".
4. Press the **Yes** soft key to reboot the base station.
5. The base station reboots to make the configuration take effect. The configuration applies to all the handsets registered to the same base station.

Note

Repeater mode and eco mode+ cancel each other out. These two features cannot be used at the same time.

For more information on how to use DECT repeater with the base station, refer to [Yealink DECT Repeater RT10 User Guide](#), [Yealink DECT Repeater RT20 User Guide](#) and [Yealink DECT Repeater RT20U User Guide](#).

Call Features

The W52P IP DECT phone is designed to be easily used like a regular phone on a public switched telephone network (PSTN). You can place internal and external calls, answer calls, transfer a call to someone else, or conduct a conference call.

This chapter provides operating instructions of the call features. Topics include:

- [Placing Calls](#)
- [Answering Calls](#)
- [Ending Calls](#)
- [Redialing Calls](#)
- [Call Mute](#)
- [Call Hold/Resume](#)
- [Call Waiting](#)
- [Do Not Disturb \(DND\)](#)
- [Call Forward](#)
- [Call Transfer](#)
- [Conference Call](#)
- [Anonymous Call](#)
- [Anonymous Call Rejection](#)
- [Voice Mail](#)
- [Shared Call Appearance \(SCA\)](#)
- [Multicast Paging](#)

If you require additional information or assistance with your new phone, contact your system administrator.

Placing Calls

When the handset is registered to the base successfully, you can use your handset to place an internal or external call. One handset can handle a maximum of 2 calls at one time, and one active call (the call that has audio associated with it) can be in progress at any time, another call is placed on hold.



Note

The base station can handle multiple calls (4 calls by default) at a time when multiple handsets are registered. For more information, contact your system administrator.

You can place a call using the following call modes:

- **Earpiece mode**—pressing the off-hook key to dial out.
- **Speakerphone mode**—pressing the Speakerphone key to dial out.
- **Earphone mode**—connecting a standard 2.5mm earphone.

During the call, you can do the following:

- Switch among the call modes by pressing the corresponding key or connecting an earphone.
- Connect or disconnect the earphone.
- Press  or  to adjust the volume of the currently engaged audio device (earpiece, earphone or Speakerphone).

You can cancel the dialing operation by pressing the on-hook key. The call duration is displayed on the LCD screen while the call is in progress.







Placing Internal Calls

You can make free internal calls between the handsets registered to the same base station. You can place an internal call to one handset or all handsets registered to the same base station. If the auto intercom feature is enabled, the handset will answer the internal call automatically. For more information, refer to [Auto Intercom](#) on page 55.







Note

The handset must be subscribed and registered to the same base station to place a call. For more information on registration, refer to [Handset Registration](#) on page 19.

To place an internal call to one handset via the handset:

1. Press  to enter the main menu.
2. Select **Intercom**.
The LCD screen displays all registered handset names and the **All HS** option.
3. Press  or  to highlight the desired handset name.
4. Press , ,  or the **OK** soft key to dial out.

To place an internal call to all handsets via the handset:





1. Press  to enter the main menu.
2. Select **Intercom**.
The LCD screen displays all registered handset names and the **All HS** option.
3. Press  or  to highlight **All HS**.
4. Press , ,  or the **OK** soft key to dial out.
All other subscribed handsets will ring simultaneously.

Placing External Calls

You can place external calls on the handset. External calls based on the public telephone network require the use of SIP lines. Your system administrator needs to assign the SIP line to the handset beforehand, and then assign the line to the handset as the outgoing line. For more information on the outgoing line, refer to [Outgoing Lines](#) on page 50.





Note The handset must be subscribed and registered to the same base station to place a call. For more information on registration, refer to [Handset Registration](#) on page 19.

To place an external call via the handset:

1. Do one of the following:
 - Enter the desired number using the keypad.
 - Press  to enter the pre-dialing screen.
Enter the desired number using the keypad.
If there are multiple lines assigned to your handset as outgoing lines, press the **Line** soft key to select the desired line.
If you do not select a line, the handset uses the default outgoing line to dial out.
2. Press ,  or  to dial out.

You can place at most two calls on your handset. You can also place an internal call during an external call.

To place a new external call during an active call via the handset:

1. Press the **New Call** soft key.
The active call is placed on hold.
2. You can do the following:
 - Enter the desired number using the keypad.
 - Press  to select a contact from Directory.
 - Press the **Option** soft key, and then select an entry from **Redial List**.
 - Press the **Option** soft key, and then select a desired line from **Select Line** when multiple lines are assigned.
3. Press ,  or  to dial out.

Note You can also make an IP call by directly dialing the IP address of any IP phone. For example, you can enter 192*168*1*15 to dial the IP 192.168.1.15.

Answering Calls

When the handset registered to the base successfully, you can answer a call in three ways:

- Using the earpiece
- Using the speakerphone
- Using the earphone

Note

You can ignore an incoming call by pressing the **Silence** soft key or reject an incoming call by pressing the on-hook key.

You can also activate Do Not Disturb mode on a per-line basis to reject all incoming calls of the specified line. For more information, refer to [Do Not Disturb \(DND\)](#) on page 67.

Answering When Not in Another Call

In all cases, the active call will appear on the LCD screen showing call duration and destination.

To answer a call using the earpiece:

1. Press  or the **Accept** soft key.

To answer a call using the speakerphone:





1. Press  .

To answer a call using the earphone:

1. With an earphone connected, press the **Accept** soft key.

Answering When in Another Call:

If you are during an active call, an incoming call arrives on the handset, do the following:

1. Press  to select the incoming call.
2. Press  ,  ,  or the **Accept** soft key.

The incoming call is answered, and the original call is placed on hold.

Ending Calls

To end an internal call:

1. Press the **End** soft key or  .

To end an external call:

Do one of the following:

- Press  .
- Place the handset in the charger cradle.





Redialing Calls

The redial list stores the twenty last dialed phone numbers. When the memory of the redial list is full, the handset will automatically erase the oldest dialed number when a new number is dialed. You can redial a call from the redial list.



To redial the last dialed number:

1. Press  twice when the handset is idle.
A call to your last dialed number is attempted.



To redial a previously dialed number:

1. Press  when the handset is idle to access the redial list.
The handset displays the dialed phone numbers.
2. Press  or  to highlight the desired entry.
You can press **Options->Edit Before Call** to edit the phone number and then select the desired line by pressing the **Line** soft key. It is only applicable to external calls.
3. Press  or  to dial out.



To add the previously dialed number to local directory (only applicable to external calls):

1. Press  when the handset is idle to access the redial list.
2. Press  or  to highlight the desired entry.
3. Press the **Options** soft key, and then select **Add To Local**.
4. Press the **OK** soft key, and then select **New Entry** or **Update Existing**.

To delete an entry from the redial number list:

1. Press  when the handset is idle to access the redial list.
2. Press  or  to highlight the desired entry.
3. Press the **Options** soft key, and then select **Delete**.

To delete all entry from the redial number list:



1. Press  when the handset is idle to access the redial list.
2. Press  or  to highlight the desired entry.
3. Press the **Options** soft key, and then select **Delete All**.
The LCD screen prompts "Delete All?".
4. Press the **Yes** soft key.

Call Mute



You can mute the microphone during an active call. When muting the microphone, you can hear the other party but he or she cannot hear you. For example, if you do not want the other party to listen to the conversation when you talk to someone in the room, you can mute the

microphone temporarily.

To mute a call:

1. Press  during an active call.
The call is muted, and the icon  is displayed on the LCD screen.

To un-mute a call:

1. Press  again.
The icon  disappears from the LCD screen.

Call Hold/Resume



You can place an active external call on hold. At any time, at most one active call can be in progress on your handset. You can answer or make another call while placing the original call on hold.

To place a call on hold:



1. Press the **Options** soft key during a call, and then select **Hold**.
The call is placed on hold, and the icon  is displayed on the LCD screen.

To resume a hold call:

Do one of the following:

- Press the **Resume** soft key.
- Press  .
- Press  .

Two calls on Hold:

If two calls are placed on hold on the handset, press the **Resume** soft key to resume the current call. Press  ,  or the **Swap** soft key to swap between two calls.





Note

When the call on the handset is placed on hold, placing the handset in the charger cradle will not end the call.

Call Waiting

You can enable or disable call waiting feature on the handset. If call waiting feature is enabled, the handset will notify you of a new incoming call during a call, and present the incoming call information visually on the LCD screen. You can also enable the handset to play a warning tone when receiving a new incoming call during a call. If call waiting feature is disabled, the new incoming call will be automatically rejected by the handset.

To configure call waiting feature via the handset:



1. Press  to enter the main menu.
2. Select **Call Features->Call Waiting**.
3. Press  or  to select the desired value from the **Status** field.
4. Press  or  to select the desired value from the **Tone** field.
5. Press the **Save** soft key to accept the change or the **Back** soft key to cancel.

Note

The call waiting tone works only if call waiting feature is enabled.

To answer a new incoming call during a call via the handset:

If call waiting feature is enabled, a new incoming call can be answered during a call.

1. Press  ,  or the **Accept** soft key to answer the new incoming call.
The original call is placed on hold.





Do Not Disturb (DND)



You can activate or deactivate the DND mode on a per-line basis. If DND mode is activated for a specific line, all incoming calls to the line will be rejected automatically, and the callers will hear a busy tone.

Note

The DND feature takes effect on the incoming lines that assigned to the handset. For more information on assigning incoming lines, refer to [Incoming Lines](#) on page 51.

To activate DND mode for a specific line via the handset:

1. Press  to enter the main menu.
2. Select **Call Features->Do Not Disturb**.
The LCD screen displays the incoming lines currently assigned to the handset. The default incoming line is highlighted and followed by a left arrow.
3. Press  or  to highlight the desired line, and then press the **OK** soft key.
4. Press  or  to select **Enabled** from the **Status** field.
5. Press the **Save** soft key to accept the change.

The icon  on the status bar indicates the DND mode is activated. You can press the **Line** soft key when the handset is idle to check the line status. The icon  at the bottom of a line indicates that the DND mode is activated for this line.

The handset will reject all incoming calls to this line, and the LCD screen displays the missed call icon  followed by the number of missed calls.

DND is configurable via web user interface at the path **Features->Forward&DND**.

Call Forward

You can enable call forward feature on a per-line basis. The handset will forward incoming calls of the line to another party.









Three forwarding types:

- **Always Forward:** Incoming calls are immediately forwarded.
- **Busy Forward:** Incoming calls are immediately forwarded if the line is busy.
- **No Answer Forward:** Incoming calls are forwarded if not answered after a period of time.

Note

The call forward feature takes effect on the incoming lines that assigned to the handset. For more information on assigning incoming lines, refer to [Incoming Lines](#) on page 51.

To enable call forward feature for a specific line via the handset:

1. Press  to enter the main menu.
2. Select **Call Features->Call Forward**.
The LCD screen displays the incoming lines currently assigned to the handset. The default incoming line is highlighted and followed by a left arrow.
3. Press  or  to highlight the desired line, and then press the **OK** soft key.
4. Press  or  to highlight the desired forwarding type, and then press the **OK** soft key.
5. Press  or  to select **Enabled** from the **Status** field.
6. Enter the destination number you want to forward incoming calls to in the **Target** field.
7. Press  or  to select the desired ring time to wait before forwarding from the **After Ring Time** field (only available for **No Answer Forward**).
8. Press the **Save** soft key to accept the change.

The icon  on the status bar indicates call forward feature is enabled.

If Always Forward is selected, there is no prompts display on the LCD screen when the line receives an incoming call. The incoming call is logged in the Received Calls list.

Call forward is configurable via web user interface at the path **Features->Forward&DND**.

Note

Call forward feature may be overridden by the server settings. For more information, contact your system administrator.



Call Transfer

You can transfer an external incoming call to another party in one of the following ways:











- **Blind Transfer:** Transfer a call directly to another party without consulting.
- **Semi-Attended Transfer:** Transfer a call when receiving the ring-back.

- **Attended Transfer:** Transfer a call with prior consulting.











To perform a blind transfer:

1. Press the **Options** soft key during a call, and then select **Transfer**.
You can also press  directly.
2. Enter the number or select the handset you want to transfer the call to.
3. Press  or the **Transfer** soft key.
The call is connected to the number or the handset you specified.

To perform a semi-attended transfer via the handset:

1. Press the **Options** soft key during a call, and then select **Transfer**.
You can also press  directly.
2. Do one of the following:
 - Enter the number or select the handset you want to transfer the call to.
Press ,  or  to dial out.
 - Press the **Directory** soft key, and then select the desired contact.
Press , ,  or the **Call** soft key.
If both the office number and the mobile number of the contact are stored, select the desired number and then press ,  or  to dial out.
3. Press  or the **Transfer** soft key to complete the transfer when receiving the ring-back.

To perform an attended transfer via the handset:

1. Press the **Options** soft key during a call, and then select **Transfer**.
You can also press  directly.
2. Do one of the following:
 - Enter the number or select the handset you want to transfer the call to.
Press ,  or  to dial out.
 - Press the **Directory** soft key, and then select the desired contact.
Press , ,  or the **Call** soft key.
If both the office number and the mobile number of the contact are stored, select the desired number and then press ,  or  to dial out.
3. Press  or the **Transfer** soft key to complete the transfer after the party answers the call.

To transfer a call to another party when there are two calls on the handset:

1. Place a call to user A.
2. Place another call to user B.
Two calls are established on the handset.
3. Select the desired call (e.g., the call with user A) and make sure the call is active.

4. Press the **Options** soft key, and then select **Call Transfer**.
The LCD screen displays the target party (user B) you will transfer the call to.
5. Press the **Transfer** soft key to complete the transfer.
The handset returns to the idle screen. Call is established between user A and User B.

Note The internal incoming call cannot be transferred.

Conference Call









You can create a conference with other two external parties using the phone's local conference. The W52P IP DECT phone also supports network conference.

Note Network conference is not available on all servers. For more information, contact your system administrator.

Local Conference

You can use the handset to create a local conference with other parties. The handset supports up to 3 parties (including yourself) in a conference call. You can create a conference between an active call and a held call on the handset (on the same line or different lines).

To set up a local conference call with two external parties via the handset:

1. Place a call to the first party.
2. Press the **Options** soft key, and then select **Conference**.
3. Do one of the following:
 - Enter the number of the second party or select the handset you want to add to the conference.
Press , ,  or the **Conf.** soft key to dial out.
 - Press the **Directory** soft key, and then select the desired contact.
Press , ,  or the **Call** soft key.
If both the office number and the mobile number of the contact are stored, select the desired number and then press , ,  or the **OK** soft key to dial out.
4. When the second party answers the call, you can consult with him or her before adding the call to the conference.
5. Press the **Conf.** soft key again to join the two calls in the conference.

To join two calls in a conference via the handset:

1. Place two calls on the handset.
2. Select the desired call and make sure the call is active.

- Press the **Options** soft key, and then select **Conference**.

Two calls are joined in the conference.

To drop the conference call, press  or the **End** soft key.

Network Conference

You can use network conference feature to conduct a conference with multiple parties. The maximum of the parties depends on the server.

This feature allows you to perform the following:

- Join two calls together into a conference call.
- Invite another party into an active conference call.

To use this feature, you need to configure the network conference URI and conference type on the phone in advance. Contact your system administrator for the conference URI.

To configure network conference feature via web user interface:

- Click on **Account->Advanced**.
- Select the desired account from the pull-down list of **Account**.
- Select **Network Conference** from the pull-down list of **Conference Type**.
- Enter the conference URI (e.g., conference01@example.com) in the **Conference URI** field.

The screenshot shows the Yealink web user interface for configuring an account. The 'Account' tab is active, and the 'Advanced' sub-tab is selected. The 'Account' dropdown is set to 'Account1'. The 'Conference Type' dropdown is set to 'Network Conference', and the 'Conference URI' field contains 'conference01@example.com'. A red box highlights these two fields. The interface includes a sidebar with navigation options like Register, Basic, Codec, Advanced, Number Assignment, and Handset Name. A 'NOTE' section on the right provides information about DTMF, Session Timer, Busy Lamp Field/BLF List, and Shared Call Appearance (SCA)/Bridge Line Appearance (BLA).









- Click **Confirm** to accept the change.

Note

Network Conference is only configurable via the web user interface.



To set up a network conference call via the handset:

- Place a call to the first party.
- Press the **Options** soft key, and then select **Conference**.

3. Do one of the following:
 - Enter the number of the second party or select the handset you want to add to the conference.
Press  ,  ,  or the **Conf.** soft key to dial out.
 - Press the **Directory** soft key, and then select the desired contact.
Press  ,  ,  or the **Call** soft key.
If both the office number and the mobile number of the contact are stored, select the desired number and then press  ,  ,  or the **OK** soft key to dial out.
4. When the second party answers the call, you can consult with him or her before adding the call to the conference.
5. Press the **Conf.** soft key again to add the new party to the conference.
6. Repeat steps 2 to 5 until you add all intended parties.

To invite another party into an active conference call via the handset:

Any party in the conference call can invite another party into an active conference call. Before the following steps, ensure that an active conference call has already existed on your IP DECT phone.

1. Press the **New Call** soft key.
2. Enter the desired number using the keypad.
3. Press  ,  or  to dial out.
4. When the new party answers the call, press the **Options** soft key, and then select **Conference**.
The new party is joined to the conference call.

To place the active conference call on hold via the handset:

1. Any party in the conference call can press the **Options** soft key, and then select **Hold**.
The party will only place himself/herself on hold. Other parties can continue the conference call normally. The conference call will only be held when all parties in the conference call place themselves on hold.

To end the conference call on the IP phone via the handset:

1. The conference initiator presses  or the **End** soft key.
If any other party in the conference ends the call, the remaining parties stay connected.

Anonymous Call

You can use anonymous call feature to block the identity and phone number from showing up to the called party when you call someone. For example, you want to call to consult some service, but do not want to be harassed. You can configure anonymous call feature on a per-line basis.

Note

The anonymous call feature takes effect on the outgoing lines that assigned to the handset. For more information on assigning incoming lines, refer to [Outgoing Lines](#) on page 50.



The anonymous call feature is not available on all servers. Contact your system administrator for more information.



To configure anonymous call feature for a specific line via the handset:

1. Press  to enter the main menu.

2. Select **Call Features->Anonymous Call**.

The LCD screen displays the outgoing lines currently assigned to the handset. The default outgoing line is highlighted and followed by a left arrow.

3. Press  or  to highlight the desired line, and then press the **OK** soft key.

4. Press  or  to select the desired value from the **Status** field.

5. Press the **OK** soft key to accept the change.

To place an anonymous call:

1. Using the specific line on the handset to place a call.

The LCD screen of the destination phone prompts an incoming call from anonymous.

Anonymous Call Code

You can configure the phone to send anonymous call on code/off code to activate/deactivate the server-side anonymous call feature via web user interface. Contact your system administrator for the anonymous call on code and off code.

To configure anonymous call code via web user interface:

1. Click on **Account->Basic**.

2. Select the desired account from the **Account** field.

3. Select the desired value from the pull-down list of **Send Anonymous Code**.

The phone will send the configured on code or off code depending on your selection when you enable or disable anonymous call feature on the phone.

- Enter the anonymous call on code and off code in the **On Code** and **Off Code** field respectively.

The screenshot shows the 'Account' settings page for 'Account1'. The 'Send Anonymous Code' section is highlighted with a red box. It contains the following fields:

Send Anonymous Code	On Code
On Code	*65
Off Code	*66

Other fields visible include 'Proxy Require', 'Local Anonymous', 'Local Anonymous Rejection', 'Send Anonymous Rejection Code', and 'Send Anonymous Rejection Code' (with 'On Code' and 'Off Code' sub-fields). Buttons for 'Confirm' and 'Cancel' are at the bottom.

- Click **Confirm** to accept the change.

Anonymous Call Rejection

You can use anonymous call rejection feature to reject incoming calls from anonymous callers. Anonymous call rejection automatically rejects incoming calls from callers who deliberately block their identities and numbers from showing up. You can configure anonymous call rejection feature on a per-line basis.

Note

The anonymous call rejection feature takes effect on the incoming lines that assigned to the handset. For more information on assigning incoming lines, refer to [Incoming Lines](#) on page 51. The anonymous call rejection feature is not available on all servers. Contact your system administrator for more information.

To configure anonymous call rejection feature for a specific line via the handset:

- Press **OK** to enter the main menu.
- Select **Call Features**->**Anon.Call Rejection**.
The LCD screen displays the incoming lines currently assigned to the handset. The default incoming line is highlighted and followed by a left arrow.
- Press **▲** or **▼** to highlight the desired line, and then press the **OK** soft key.
- Press **◀** or **▶** to select the desired value from the **Status** field.
- Press the **OK** soft key to accept the change.

Anonymous Call Rejection Code

You can configure the phone to send anonymous call rejection on code/off code to activate/deactivate the server-side anonymous call rejection feature via web user interface. Contact your system administrator for the anonymous call rejection on code and off code.

To configure anonymous call rejection code via web user interface:

1. Click on **Account**->**Basic**.
2. Select the desired account from the **Account** field.
3. Select the desired value from the pull-down list of **Send Anonymous Rejection Code**.
The phone will send the configured on code or off code depending on your selection when you enable or disable anonymous rejection call feature on the phone.
4. Enter the anonymous call rejection on code and off code in the **On Code** and **Off Code** field respectively.

The screenshot shows the Yealink W52P/W56P web interface. The 'Account' tab is selected, and the 'Basic' sub-tab is active. The 'Send Anonymous Rejection Code' section is highlighted with a red box. It includes a dropdown menu for 'Send Anonymous Rejection Code' (set to 'On Code'), and input fields for 'On Code' (set to '*65') and 'Off Code' (set to '*66'). Below this, there is another dropdown for 'Send Anonymous Rejection Code' (set to 'On Code'), and input fields for 'On Code' (set to '*67') and 'Off Code' (set to '*68'). A 'Confirm' button is at the bottom left and a 'Cancel' button is at the bottom right. A 'NOTE' box on the right explains that 'Anonymous Call Rejection' rejects anonymous calls automatically and provides a link to more guides.

5. Click **Confirm** to accept the change.

Voice Mail

You can leave voice mails to someone else. You can also receive and listen to voice mails via the handset. Voice mail feature ensures that you will never miss any important messages. When receiving a new voice mail, the icon  appears on the LCD screen with the number of unread voice mails, and the message key LED flashes red.

Note

Voice mail feature is not available on all servers. Contact your system administrator for more information.

Voice Mail Tone

You can enable or disable the phone to play a warning tone when receiving a voice mail. Voice mail tone is enabled by default.

To configure the voice mail tone via web user interface:

1. Click on **Features->General Information**.
2. Select the desired value from the pull-down list of **Voice Mail Tone**.

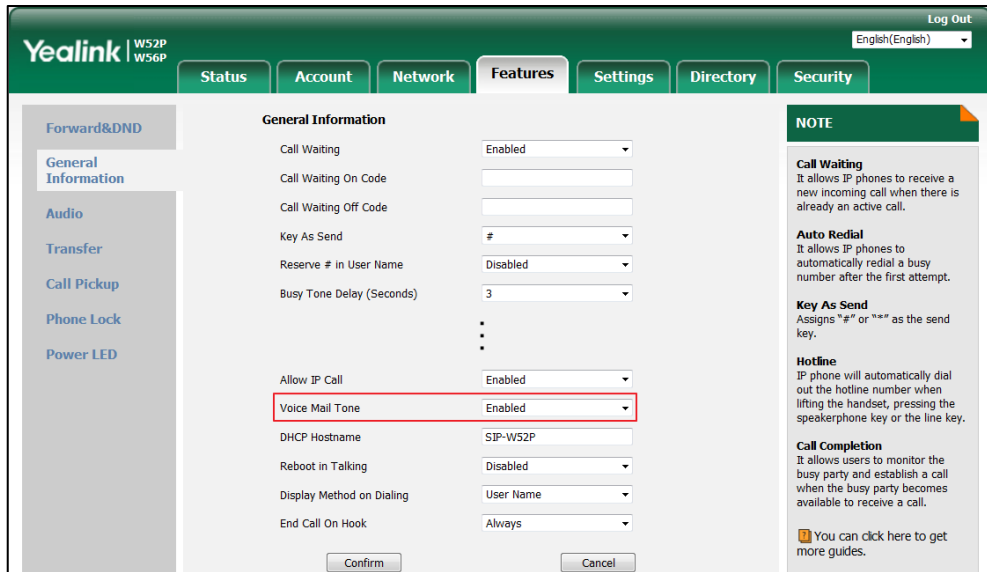

3. Click **Confirm** to accept the change.

Note Voice mail tone is configurable via web user interface only.

To leave a voice mail:

You can leave a voice mail to someone else when he or she is busy or inconvenient to answer the call. Follow the voice prompts from the system server to leave a voice mail, and then hang up.

To configure the voice mail access code via the handset:



1. Press **OK** to enter the main menu.
2. Select **Voice Mail->Set Voice Mail**.
3. (Optional.) Press **▲** or **▼** to highlight the desired line, and then press the **Select** soft key.
4. Press **◀** or **▶** to select **Enabled** from the **Status** field.
5. Enter the voice mail access code in the **Number** field (e.g., *4).
6. Press the **OK** soft key to accept the change or the **Back** soft key to cancel.

Note Voice mail access codes must be predefined on the system server. Contact your system administrator for the more information.

To configure fast access for voice mail via the handset:



You can configure fast access to the voice mails of the desired line by long pressing the digit key

1 without having to scroll through the menu when the handset is idle.

1. Press  to enter the main menu.
2. Select **Voice Mail**->**Set Key 1**.
3. (Optional.) Press  or  to highlight the desired line and then press the **Select** soft key.

The radio box of the selected line is marked.

To listen to the voice mail using the menu via the handset:

1. Press  to enter the main menu.
2. Select **Voice Mail**->**Play Message**.
3. (Optional.) Press  or  to highlight the desired line, and then press the **Select** soft key.

The handset dials out the voice mail access code using the selected line automatically.

Follow the voice prompt from the system server to listen to your voice mails.

Note

Before listening to voice mails, make sure the voice mail access code has been configured.

To listen to the voice mail via fast access via the handset:

1. Long press  when the handset is idle.

The handset automatically dials out the voice mail access code using the line you selected when configuring fast access for voice mail.

If you have not set the voice mail access code, it will enter the setting screen, you should configure it first.

2. Follow the voice prompt from the system server to listen to your voice mails.

You can also listen to the voice mail by pressing  to enter the Messages & Calls screen.

Select the desired line and then press the **Select** soft key.

Note

Before listening to the voice mails, make sure the voice mail access code has been configured.

When all new voice mails are retrieved, the icon  will disappear from the screen.

Shared Call Appearance (SCA)

You can use Shared Call Appearance (SCA) feature to share an extension which can be registered on two or more IP phones at the same time.

If two phones share a line, an incoming call to this extension will cause both phones to ring simultaneously. The incoming call can be answered on either a phone but not both.

This feature is very useful in the boss and secretary scenario. For example, the secretary can share the boss's extension on her phone. When there is an incoming call to the extension of the

boss, both the phones of the boss and the secretary will ring simultaneously. Either the boss or the secretary can answer the call. Calls on the shared line can be placed on hold or barged in.

Configuring SCA Feature

You can configure a primary account on the DECT phone and other alternate accounts on other IP phones. For example, party A and party B share the account 4603, DECT phone A registers the primary account 4603, land-line phone B registers the alternate account 4603_1, DECT phone C registers the account 4605.

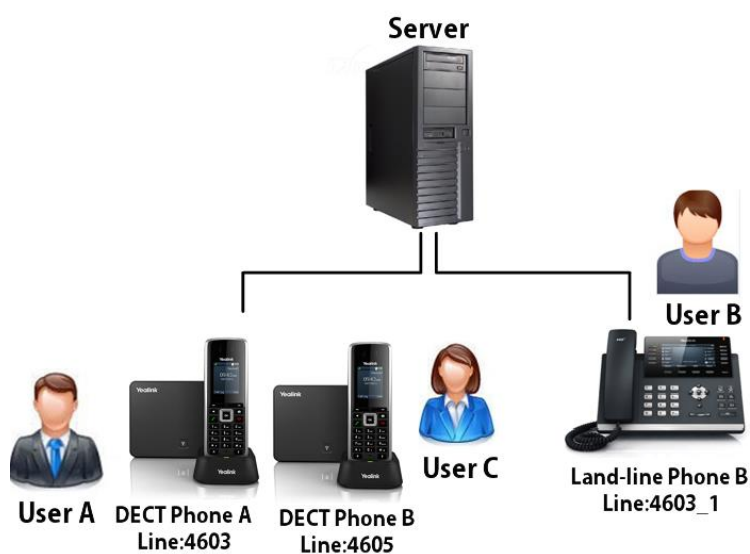

To configure the primary line settings on DCET phone via web user interface:

1. Register the primary account 4603.

The screenshot shows the 'Account' configuration page for 'Account 1'. The 'Line Active' dropdown is set to 'Enabled'. The 'SIP Server 1' section is highlighted with a red box. The 'SIP Server 1' fields include Server Host (pbx.yealink.com), Transport (UDP), Server Expires (3600), and Server Retry Counts (3). The 'Enable Outbound Proxy Server' dropdown is also set to 'Enabled', and the 'Outbound Proxy Server 1' field is set to 10.1.8.11. The 'NAT' dropdown is set to 'Disabled'.

2. Click on **Advanced**, select **Share Call Appearance** from the pull-down list of **Shared Line**.

The screenshot shows the 'Account' configuration page for 'Account 1'. The 'Advanced' tab is selected in the left sidebar. The 'Shared Line' dropdown is highlighted with a red box and set to 'Shared Call Appearance'. The 'Advanced' fields include Keep Alive Type (Default), Keep Alive Interval(Seconds) (30), RPort (Disabled), Subscribe Period(Seconds) (1800), PTime(ms) (20), SIP Send MAC (Disabled), SIP Send Line (Disabled), SIP Registration Retry Timer(0~1800s) (30), Conference Type (Local Conference), Conference URI, SIP Server Type (Default), Unregister When Reboot (Disabled), VQ RTPC-XR Collector name, VQ RTPC-XR Collector address, and VQ RTPC-XR Collector port (5060).

3. Click **Confirm** to accept the change.

To configure the shared line settings on land-line IP phone via web user interface:

1. Register the alternate account 4603_1 on phone B.
(Enter the primary account 4603 in the **Register Name** field).
2. Click on **Advanced**, select **Share Call Appearance** from the pull-down list of **Shared Line**.
3. Click **Confirm** to accept the change.

Using SCA Feature on the Handset









You can do the following using SCA feature by the handset:

- Placing an SCA call
- Answering calls
- Placing/Retrieving a call on hold
- Barging in an active call
- Pulling a shared call

Placing an SCA call

To place a call on the shared line:

Do one of following:

- Enter the desired number using the keypad when the handset is idle.
Press ,  or  to dial out.
If there are multiple lines assigned to your handset as outgoing lines, press the **Line** soft key to select the shared line and then press  or the **Dial** soft key to dial out. If you do not select a line, the handset uses the default outgoing line to dial out.
- Press  to enter the pre-dialing screen.
Enter the desired number using the keypad.
Press ,  or  to dial out.
If there are multiple lines assigned to your handset as outgoing lines, press the **Line** soft key to select the shared line and then press  or the **Dial** soft key to dial out. If you do not select a line, the handset uses the default outgoing line to dial out.

Answering Calls

You can have one call or two calls on the shared line. When an incoming call arrives on the shared line from User C, both DECT phone A and land-line phone B ring simultaneously. The LCD screen of DECT phone A and land-line phone B display the incoming call information.

You can answer the incoming call on either DECT phone A or land-line phone B but not both.

To answer a call on the shared line by handset A:

1. Press  ,  ,  or the **Accept** soft key. The land-line phone B stops ringing.

An incoming call arrives when there is an active call on the shared line, both the DECT phone A and land-line phone B ring. The LCD screen of DECT phone A and land-line phone B display the incoming call information.

You can answer the incoming call on either DECT phone A or land-line phone B.

To answer another call when there is an active call on land-line phone B by handset A:

1. Press  ,  ,  or the **Accept** soft key. The land-line phone B stops ringing.

The incoming call is answered, and the original call is placed on hold.

If the land-line phone B answer the incoming call, the DECT phone A stops ringing.

Note

Make sure call waiting feature is enabled on phone A. For more information, refer to [Call Waiting](#) on page 66.

Placing/Retrieving a Call on Hold

During the SCA call, two types of hold are available: public hold and private hold. When an SCA call is placed on public hold, the held call is available for any shared location to retrieve. When an SCA call is hold privately, the held call can only be retrieved from the shared location that placed the call on hold.

Using Public Hold

To place an SCA call on public hold by handset A:

1. Press the **Options** soft key.
2. Select **Hold**, and then press the **OK** soft key.

The SCA call is placed on public hold.

You can retrieve the public held call on either DECT phone A or land-line phone B.

To retrieve a call placed on public hold by handset A:

- If the SCA call is placed on public hold on land-line phone B.
Press the **SCA** soft key on handset, and then select the held call.
Press the **Resume** soft key on handset to retrieve the call from land-line phone B.
- If the SCA call is placed on public hold on DECT phone A:
Press the **Resume** soft key on handset to retrieve the call directly.

If both DECT phone A and land-line phone B have an active call, and the call on land-line phone B is placed on public hold, you can retrieve the call on DECT phone A.

To retrieve another call that placed on public hold by handset A:

1. Place the current call on hold.

2. Press the **Line** soft key, the screen displays the calls on held.
3. Press the **Resume** soft key to resume the held call on land-line phone B.

Using Private Hold

To place a call on private hold by handset A:

1. Press the **Options** soft key, and then select **Private Hold**.
2. Press the **OK** soft key.

The SCA call is held privately. User A can press the **Resume** soft key on handset to resume the held call. User B is not able to retrieve the private held call.

Barging an Active SCA Call

SCA bridging feature allows SCA users to barge in an active call, and establish a conference call with the third party.

To barge in an active SCA call by handset:

An SCA call is established between land-line phone B and DECT phone C.

1. Press the **SCA** soft key on DECT phone A.

Visual indicator on the LCD screen of the DECT phone A indicates that the shared line is in the active state.

2. Select the active call you want to barge in.
3. Press the **BargeIn** soft key to barge in.



A conference call is established among DECT phone A, land-line phone B and DECT phone C.

If an SCA user (User A or User B) cancels the call, the other SCA user is still connected to the remaining party. If the third party (User C) cancels the call, the call ends.

Pulling a Shared Call

You can pull an existing call from another shared phone that is in active or hold state. To use this feature, contact your system administrator for the call pull feature access code.

To pull a shared call on the shared line:

1. Enter the desired call pull feature access code using the keypad when the handset is idle.
2. Press ,  or  to dial out.

Multicast Paging

You can use multicast paging to quickly and easily broadcast time-sensitive announcements to people who are listening to a specific multicast group and a specific channel. You can configure a paging list, which allows you to send a Real Time Transport Protocol (RTP) stream to the pre-configured multicast address(es) and channel(s) without involving SIP signaling. You can

configure the phone to receive an RTP stream from pre-configured multicast listening address(es) and channel(s) without involving SIP signaling. You can specify up to 31 multicast listening addresses and channels.

The following describes 31 paging channels:

- **0:** You can broadcast audio to channel 0. Note that the Yealink IP phones running old firmware version (old paging mechanism) can be regarded as listening to channel 0. It is the default channel.
- **1 to 25:** You can broadcast audio to a specific channel. We recommend that you specify these channels when broadcasting with Polycom IP phones which have 25 channels you can listening to.
- **26 to 30:** You can broadcast audio to a specific channel. We recommend that you specify these channels when broadcasting with Yealink IP phones running new firmware version (new paging mechanism).

The IP phones will automatically ignore all incoming multicast paging calls on the different channel.

Note The IP phones on different network segment cannot send/receive RTP stream to/from pre-configured multicast address(es) and channel(s).

Sending RTP Stream

To configure paging list via web user interface:

1. Click on **Directory**->**Multicast IP**.
2. Enter the multicast IP address(es) and port number (e.g., 224.5.6.20:10008) in the **Paging Address** field.
3. Enter the string that will appear on the LCD screen in the **Label** field.

- Select the desired channel from the pull down list of **Channel**.

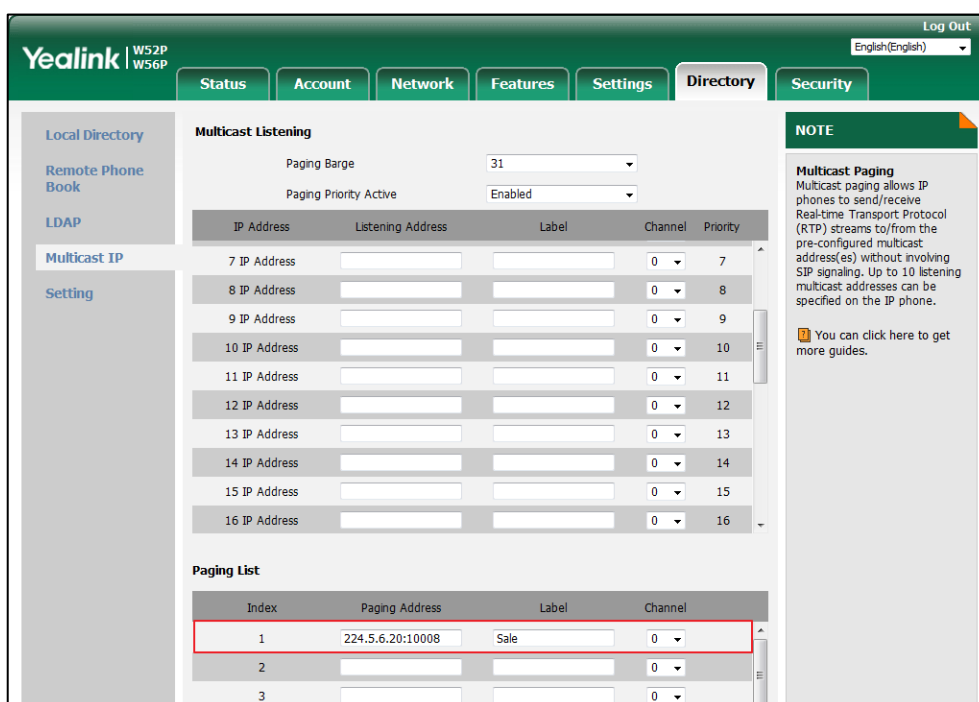

- Click **Confirm** to accept the change.

To configure a default codec for multicast paging via web user interface:

- Click on **Features->General Information**.
- Select the desired codec from the pull-down list of **Multicast Codec**.

The default codec is G722.

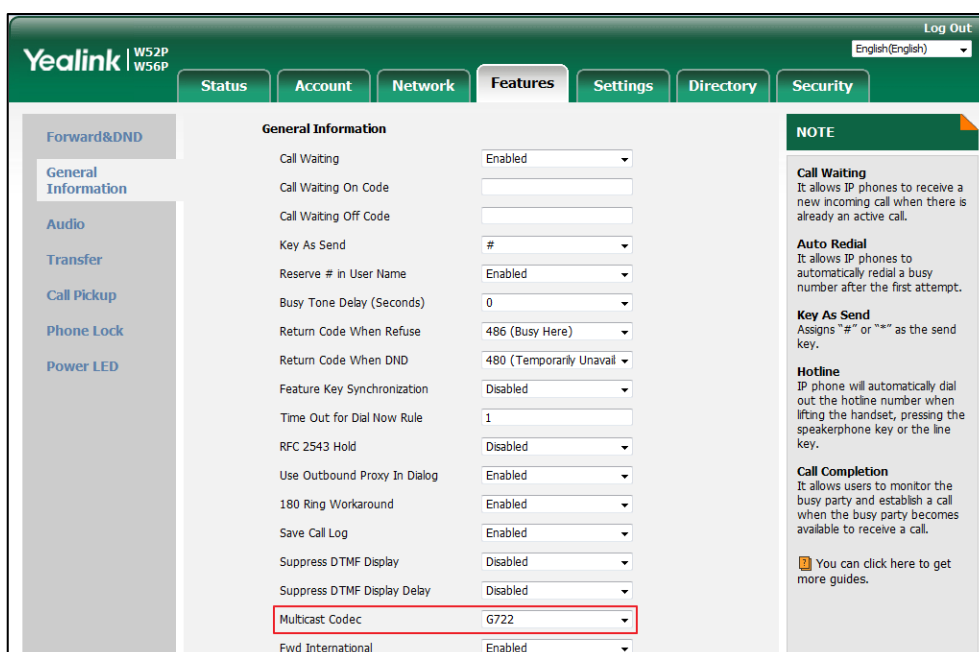

- Click **Confirm** to accept the change.

Note Default codec for multicast paging is configurable via web user interface only.

Receiving RTP Stream

You can configure the phone to receive a Real Time Transport Protocol (RTP) stream from the pre-configured multicast address(es) and channel(s) without involving SIP signaling. You can specify up to 31 multicast addresses and channels that the phone listens to on the network.

Note

RTP stream is listened in the speakerphone mode by default. If you want to listen the RTP stream using the engaged audio device (earpiece, earphone or speakerphone), contact your system administrator for more information.

Fixed volume to play RTP stream for specified paging group is configurable by your system administrator.

How the phone handles incoming multicast paging calls depends on Paging Barge and Paging Priority Active parameters are configured via web user interface.

Paging Barge

The paging barge parameter defines the priority of the voice call in progress. If the priority of an incoming multicast paging call is lower than that of the active call, it will be ignored automatically. If Disabled is selected from the pull-down list of Paging Barge, the voice call in progress will take precedence over all incoming multicast paging calls. Valid values in the Paging Barge field:

- **1 to 31:** Define the priority of the active call, 1 with the highest priority, 31 with the lowest.
- **Disabled:** The voice call in progress will take precedence over all incoming paging calls.

Paging Priority Active

The paging priority active parameter decides how the phone handles incoming multicast paging calls when there is already a multicast paging call on the phone. If enabled, the phone will ignore incoming multicast paging calls with lower priorities, otherwise, the phone will answer incoming multicast paging calls automatically and place the previous multicast paging call on hold. If disabled, the phone will automatically ignore all incoming multicast paging calls.

To configure multicast listening addresses via web user interface:

1. Click on **Directory->Multicast IP**.
2. Select the desired value from the pull-down list of **Paging Barge**.
3. Select the desired value from the pull-down list of **Paging Priority Active**.
4. Enter the multicast IP address(es) and port number (e.g., 224.5.6.20:10008) which the phone listens to for incoming RTP multicast in the **Listening Address** field.
5. (Optional.) Enter the label in the **Label** field.
Label will appear on the LCD screen when receiving the multicast RTP stream.
6. Select the desired channel to listen from the pull-down list of **Channel**.

The default channel is 0.

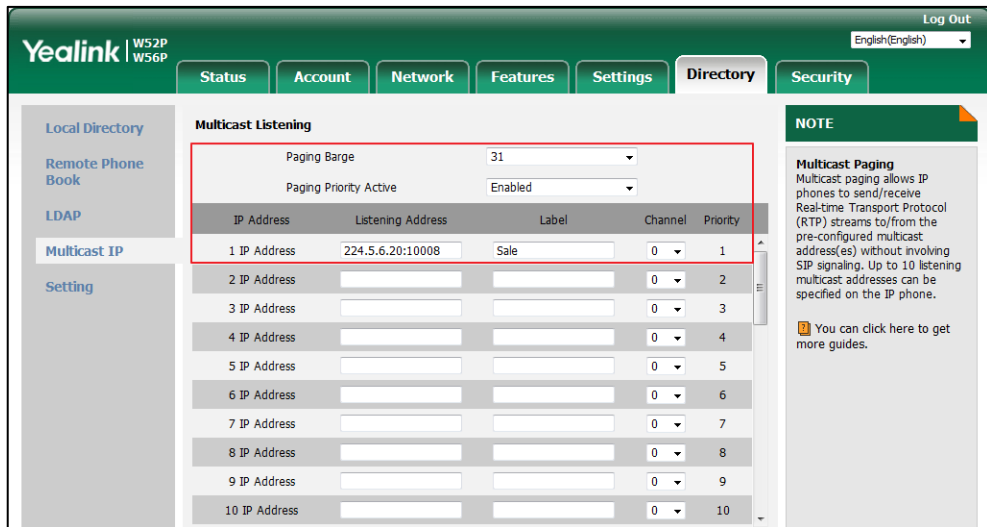

7. Click **Confirm** to accept the change.

Note The priorities of listening addresses are predefined: 1 with the highest priority, 31 with the lowest. Multicast listening addresses are configurable via web user interface only.

Using Multicast Paging

To send RTP stream when the receiver's phone is idle:

1. Press **OK** to enter the main menu.
2. Select **Call Features**->**Paging List**.
3. Press **▲** or **▼** to highlight the desired paging group.
4. Press the **Paging** soft key.

The handset sends RTP to a preconfigured multicast address (IP: Port).

Both the sender's and receiver's phones play a warning tone and the receiver automatically answers the multicast RTP session.

If there is only one paging group in the paging list, the handset sends RTP to the multicast address (IP: Port) directly.

Your can do the following during paging:

- To place the current multicast RTP session on hold, press the **Hold** soft key.
The sender's phone places the multicast RTP session on hold and receiver's phone releases the session.
To resume the held multicast RTP session, press the **Resume** soft key.
The multicast RTP session is established again.
- To end the multicast RTP session, press the **End** soft key.

Troubleshooting

This chapter provides some general troubleshooting information to help you solve the problems you might encounter when using your W52P IP DECT phone.

If you require additional information or assistance with your new phone, contact your system administrator.

Base Issue

Why doesn't the power indicator on the base station light up?

Plug the supplied power adapter to W52P, if the power indicator doesn't light up, it should be a hardware problem. Please contact your vendor or local distributor and send the problem description for help. If you cannot get a support from them, please send a mail which includes problem description, test result, your country and phone's SN to Support@yealink.com.



Why doesn't the network indicator on the base station light up slowly flash?

It means that the W52P cannot get an IP address. Try connecting the W52P to another switch port, if the network indicator still slowly flashes, please try a reset.

Handset Issue

To recognize the area of handset via the handset:

1. Press  to enter the main menu.
2. Select **Status**->**Handset**.

The LCD screen displays status information of handset status, you can press  or  to scroll through to the **Area** field.

Why can't I turn the handset on?

Ensure the battery is inserted into the handset. If the battery is already inserted into the handset, place the handset in the charger cradle.

Register Issue

Why cannot the handset be registered to the base station?

If the network works normally, you can check the compatibility between base station and handset. There are 2 sets of base stations, complied with the FCC and CE standards respectively. You can check it from the back of the base station. There are also 2 sets of handsets, American and Europe area respectively.

The American area handset is compatible with FCC standard base station.

The Europe area handset is compatible with CE standard base station.

Call Issue

Why can't I receive calls?

- Ensure that the DND mode is not activated. Refer to [Do Not Disturb \(DND\)](#) on page 67.
- Ensure that Always Forward feature is not enabled. Refer to [Call Forward](#) on page 67.

Why do I hear some noise during a call?

- Ensure that you are not using the handset or base station in an area with high electrical interference. You can reposition the handset and the base station to keep them far away from sources of high electrical interference.
- Ensure that the handset is not too far from the base station.
- Restart the base station and place a call to see if there is still noise heard during the call.

Paging Issue

Why does paging fail?

- Check the current mode of the base station. If the base station is not in the paging mode, press the paging key on the base station to enter the paging mode.
- Ensure that there is at least one handset registered to the base station.

Audio Issue

Why doesn't the handset ring?

- Ensure that the ringer volume of your handset is not adjusted to the minimum. Refer to [Adjusting Volume](#) on page 25.
- Ensure that the silent mode is not switched to On. Refer to [Switching Silent Mode to](#)

[On/Off](#) on page 26.

Why can I hear the verification tone from handset if the call is successfully handled by the repeater?

To deactivate the verification tone on the repeater:

1. Switch off the repeater (disconnect the power adapter).
2. Switch it on for 1 to 5 seconds and switch it off again.
3. Switch it on again. The LED indicator on the repeater flashes slowly.
4. Switch it off again.
5. Switch it on again.

The verification tone is then deactivated. If you want to activate the verification tone, repeat the above steps.

Display Issue

Why does the handset prompt the message “Not Subscribed”?

Check the registration status of your handset. If your handset is not registered to the base station, register it manually. Refer to [Handset Registration](#) on page 19.

Why does the handset prompt the message “Not In Range” or “Out Of Range”?

- Ensure that the base station is properly plugged into a functional AC outlet.
- Ensure that the handset is not too far from the base station.

Why does the handset prompt the message “Network unavailable.”?

- Ensure that the Ethernet cable is plugged into the Internet port on the base station and the Ethernet cable is not loose.
- Ensure that the switch or hub in your network is operational.

Update & Reset Issue

How to upgrade firmware?

To upgrade base station/handset firmware via web user interface:

1. Click on **Settings**->**Upgrade**.
2. In the **Select And Upgrade Firmware** or **Select and Upgrade Handset Firmware** field, click **Browse** to locate the firmware file from your local system.
3. Click **Upgrade** to upgrade the firmware of the base station or handset.
4. Click **OK** to confirm upgrading.

The upgrading process will take a few minutes. The power indicator LED on the base station flashes during the firmware upgrading process.

Once the base station firmware has been successfully upgraded, the base station reboots automatically. The handset will perform an auto registration to the base station.

You can check the firmware version of the base station via the handset. For more information, refer to [Checking System Status](#) on page 23.

Note

Do not refresh or close the browser, or power off during the upgrading process of the base station/handset.

How to restore the system PIN?

1. Disconnect the power adapter.
2. Long press the paging key and reconnect the power adapter.

When base station finishes reset, the power indicator LED, network status LED and registration LED illuminate in sequence. System PIN and all individual settings are reset to factory defaults. Handset registrations will also be cleared after base station reset.

Log Issue

How to export PCAP trace?

We may need you to provide a PCAP trace to help analyze your problem.

To export a PCAP trace via web user interface:

1. Click on **Settings->Configuration**.
2. In the **Pcap Feature** field, click **Start** to begin capturing signal traffic.
3. Recreate the error to be documented in the trace.

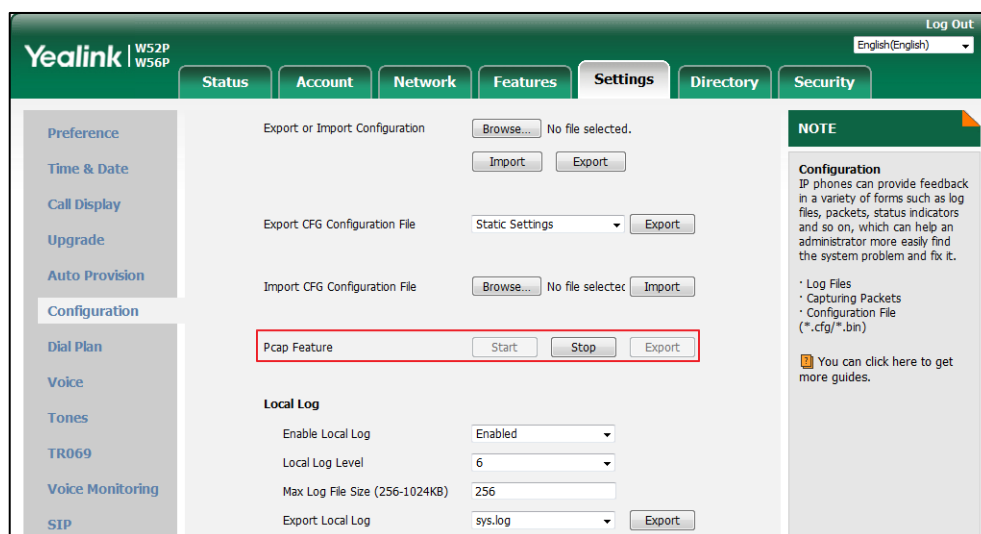

4. Click **Stop** to stop the capture.

5. Click **Export** to open file download window, and then save the file to your local system.

How to export system log?

We may need you to provide a system log or boot log to help analyze your problem.

To export the system log to a local PC via web user interface:

1. Click on **Settings->Configuration**.
2. Select **Enabled** from the pull-down list of **Enable Local Log**.
3. Select **6** from the pull-down list of **Local Log Level**.
The default local log level is "3".
4. Select **sys.log** from the pull-down list of **Export Local Log**.

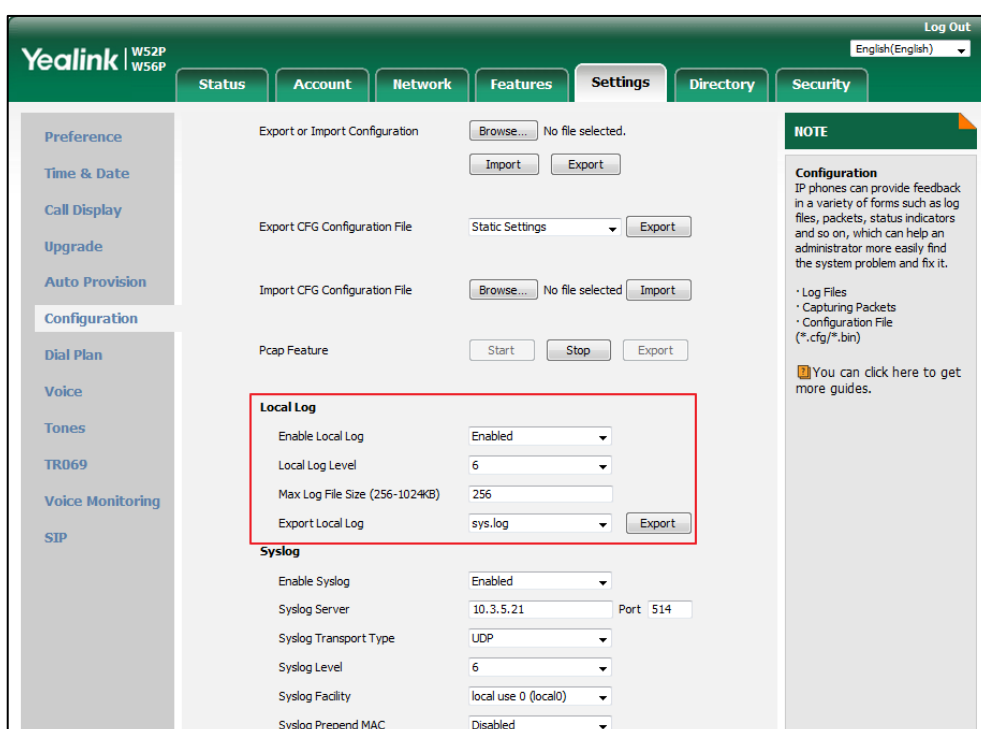

5. Click **Confirm** to accept the change.
6. Reproduce the issue.
7. Click **Export** to open the file download window, and then save the file to your local system.

You can also export the system log to a syslog server. Contact your system administrator for more information.

Note

It is recommended to reset the local log level to 3 after exporting the system log.

To export the boot log to a local PC via web user interface:

1. Click on **Settings->Configuration**.
2. Select **Enabled** from the pull-down list of **Enable Local Logging**.
3. Select **boot.log** from the pull-down list of **Export Local Log**.
4. Click **Confirm** to accept the change.
5. Click **Export** to open the file download window, and then save the file to your local system.

How to export all diagnostic files?

We may need you to provide three types of diagnostic files (including PCAP trace, system log and BIN configuration file) to help analyze your problem. You can export these files at a time.

To export all diagnostic files via web user interface:

1. Click on **Settings->Configuration**.

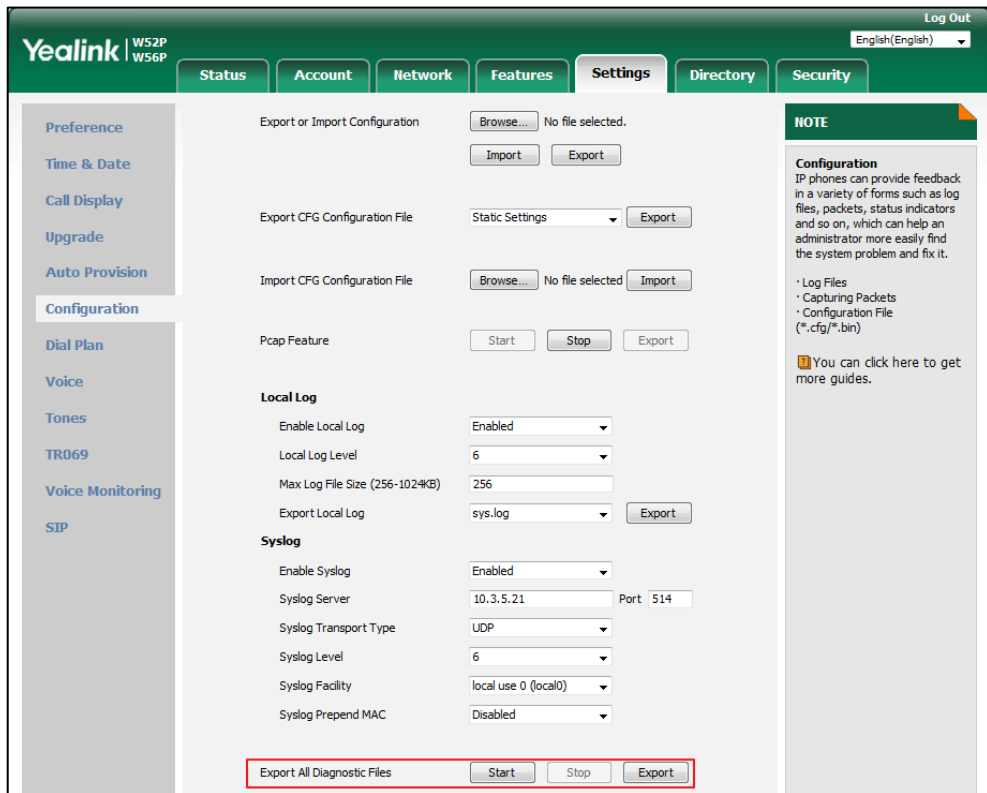

2. Click **Start** to begin capturing signal traffic.
The system log level will be automatically set to 6.
3. Reproduce the issue.
4. Click **Stop** to stop the capture.
The system log level will be reset to 3.

5. Click **Export** to open file download window, and then save diagnostic files to your local system.

Note

If the issue cannot be reproduced, just directly click **Export** to export all diagnostic files.

Appendix

Appendix A - Time Zones

Time Zone	Time Zone Name
-11	Samoa
-10	United States-Hawaii-Aleutian, United States-Alaska-Aleutian
-9:30	French Polynesia
-9	United States-Alaska Time
-8	Canada(Vancouver,Whitehorse), Mexico(Tijuana,Mexicali), United States-Pacific Time
-7	Canada(Edmonton,Calgary), Mexico(Mazatlan,Chihuahua), United States-MST no DST, United States-Mountain Time
-6	Canada-Manitoba(Winnipeg), Chile(Easter Islands), Mexico(Mexico City,Acapulco), United States-Central Time
-5	Bahamas(Nassau), Canada(Montreal,Ottawa,Quebec), Cuba(Havana), United States-Eastern Time
-4:30	Venezuela(Caracas)
-4	Canada(Halifax,Saint John), Chile(Santiago), Paraguay(Asuncion), United Kingdom-Bermuda(Bermuda), United Kingdom(Falkland Islands), Trinidad&Tobago
-3:30	Canada-New Foundland(St.Johns)
-3	Argentina(Buenos Aires), Brazil(DST), Brazil(no DST), Denmark-Greenland(Nuuk)
-2:30	Newfoundland and Labrador
-2	Brazil(no DST)
-1	Portugal(Azores)
0	Denmark-Faroe Islands(Torshavn), GMT, Greenland, Ireland(Dublin), Morocco, Portugal(Lisboa,Porto,Funchal), Spain-Canary Islands(Las Palmas), United Kingdom(London)
+1	Albania(Tirane), Austria(Vienna), Belgium(Brussels), Caicos, Chad, Croatia(Zagreb), Czech Republic(Prague), Denmark(Kopenhagen), France(Paris), Germany(Berlin), Hungary(Budapest), Italy(Rome), Luxembourg(Luxembourg), Macedonia(Skopje), Namibia(Windhoek), Netherlands(Amsterdam), Spain(Madrid)
+2	Estonia(Tallinn), Finland(Helsinki), Gaza Strip(Gaza), Greece(Athens), Israel(Tel Aviv), Jordan(Amman), Latvia(Riga), Lebanon(Beirut), Moldova(Kishinev), Romania(Bucharest), Russia(Kaliningrad), Syria(Damascus), Turkey(Ankara), Ukraine(Kyiv, Odessa)





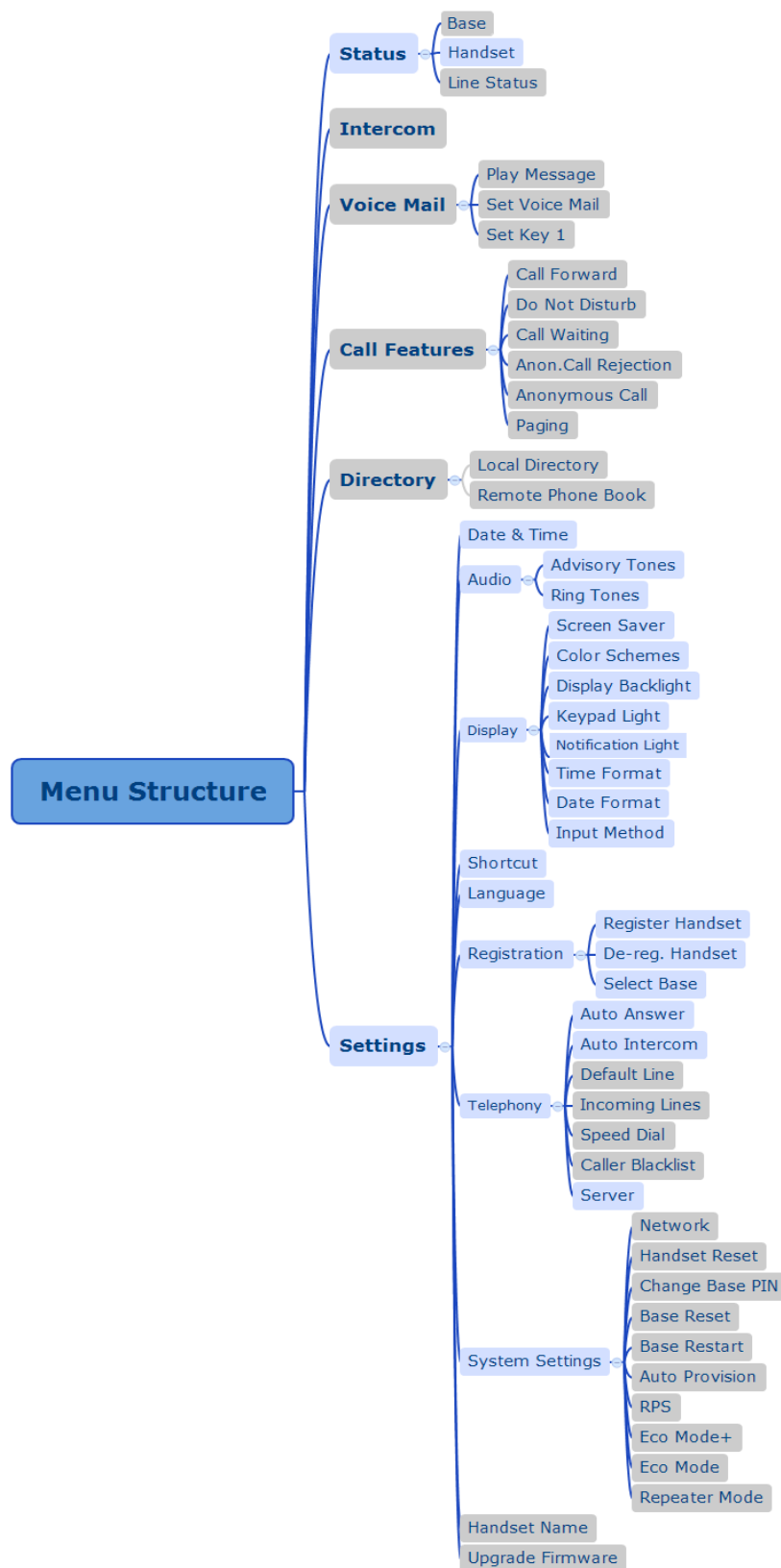





Time Zone	Time Zone Name
+3	East Africa Time, Iraq(Baghdad), Russia(Moscow)
+3:30	Iran(Teheran)
+4	Armenia(Yerevan), Azerbaijan(Baku), Georgia(Tbilisi), Kazakhstan(Aktau), Russia(Samara)
+4:30	Afghanistan(Kabul)
+5	Kazakhstan(Aqtobe), Kyrgyzstan(Bishkek), Pakistan(Islamabad), Russia(Chelyabinsk)
+5:30	India(Calcutta)
+5:45	Nepal(Katmandu)
+6	Kazakhstan(Astana, Almaty), Russia(Novosibirsk,Omsk)
+6:30	Myanmar(Naypyitaw)
+7	Russia(Krasnoyarsk), Thailand(Bangkok)
+8	Australia(Perth), China(Beijing), Russia(Irkutsk, Ulan-Ude), Singapore(Singapore)
+8:45	Eucla
+9	Japan(Tokyo), Korea(Seoul), Russia(Yakutsk,Chita)
+9:30	Australia(Adelaide), Australia(Darwin)
+10	Australia(Brisbane), Australia(Hobart), Australia(Sydney,Melbourne,Canberra), Russia(Vladivostok)
+10:30	Australia(Lord Howe Islands)
+11	New Caledonia(Noumea), Russia(Srednekolymsk Time)
+11:30	Norfolk Island
+12	New Zealand(Wellington,Auckland), Russia(Kamchatka Time)
+12:45	New Zealand(Chatham Islands)
+13	Tonga(Nukualofa)
+13:30	Chatham Islands
+14	Kiribati

Appendix B - Menu Structure



Note The menus with gray box are not available when the handset does not register to a base station.

Appendix C - Input Modes and Characters

Input Mode Keypad	Abc (initials in capitals)	123	ABC	abc	ABГ	АĂĂ	aăă	SŚŠ	sśš	абв	АБВ
	1	1	1	1	1	1	1	1	1	1	1
	ABCabc2	2	ABC2	abc2	ABГ2	АĂĂĂĂĂ ÆBCÇ2	aăăăăăæb çç2	АĂĂĂBCČČ 2	aăăăbcčč2	АБВГ2	абвр2
	DEFdef3	3	DEF3	def3	ΔEZ3	DEĚĚĚĚĚF3	deëëëëëf3	DĎĚĚĚĚF3	dd'ëëëëf3	ДЕЖЗ3	дежз3
	GHIghi4	4	GHI4	ghi4	HOI4	GĜHIĪĪĪĪ4	gĝhiĭĭĭĭi4	GHIÍ4	ghií4	ИЙКЛ4	ийкл4
	JKLjkl5	5	JKL5	Jkl5	ΚΛΜ5	JKL5	jkl5	JKLŁŁŁ5	jkłłł5	МНОП5	мноп5
	MNOmno6	6	MNO6	mno6	ΝΞΟ6	MNŃŃŃŃŃŃ ŌŌŌŌŌ6	mñññññññ öø6	MNŃŃŃŃŃŃ ŌŌŌ6	mñññññññ ö6	РСТУ6	рсту6
	PQRSpqrs7	7	PQRS7	pqrs7	ΠΡΣ7	PQRŠŠB7	pqrššb7	PQRŘŘSŚŠ 7	pqrřřsśš7	ФХЦЧ7	фхцч7
	TUVtuv8	8	TUV8	tuv8	ΤΥΦ8	TUÚÚÚÚÚ V8	tuùùùùùv8	TŤUÚÚÚÚ V8	tt'úúúúv8	ШЩЪЫ8	шщъы8
	WXYZwxyz 9	9	WXYZ9	Wxyz9	ΧΨΩΥ9	WŴXŶŸZ9	wŵxyŷz9	WXYŸŸZŹZ Z9	wxyŷŷzzz9	ЪЭЮЯ9	ъэюя9
	space . , ? ! 0	0	0 . , ? ! space	0 . , ? ! space	space 0	space 0	space 0	space 0	space 0	0 Γ€İŸ	0г€iïŸ

Input Mode Keypad	Abc (initials in capitals)	123	ABC	abc	ABГ	AÄÅ	aää	SŠŠ	sšš	абв	АБВ
	space = /\ ^ ; : , . - + * # \$ % @ ? ! ¿ i () { } [] < > ¥ \$ £ ~ □	space _ ' " = / \ ^ ; : , . - + * # \$ % @ ? ! ¿ i () { } [] < > ¥ \$ £ ~ □	space _ ' " = / \ ^ ; : , . - + * # \$ % @ ? ! ¿ i () { } [] < > ¥ \$ £ ~ □	space _ ' " = / \ ^ ; : , . - + * # \$ % @ ? ! ¿ i () { } [] < > ¥ \$ £ ~ □	space _ ' " = / \ ^ ; : , . - + * # \$ % @ ? ! ¿ i () { } [] < > ¥ \$ £ ~ □	space _ ' " = / \ ^ ; : , . - + * # \$ % @ ? ! ¿ i () { } [] < > ¥ \$ £ ~ □	space _ ' " = / \ ^ ; : , . - + * # \$ % @ ? ! ¿ i () { } [] < > ¥ \$ £ ~ □	space _ ' " = / \ ^ ; : , . - + * # \$ % @ ? ! ¿ i () { } [] < > ¥ \$ £ ~ □	space _ ' " = / \ ^ ; : , . - + * # \$ % @ ? ! ¿ i () { } [] < > ¥ \$ £ ~ □	space _ ' " = / \ ^ ; : , . - + * # \$ % @ ? ! ¿ i () { } [] < > ¥ \$ £ ~ □	space _ ' " = / \ ^ ; : , . - + * # \$ % @ ? ! ¿ i () { } [] < > ¥ \$ £ ~ □

Regulatory Notices

Important Safety Information

To reduce risk of fire, severe personal injury and damage to property, read the following safety information carefully before using the product.

Environmental Requirements

- Place the product on a stable, level and non-slip surface.
- Do not place the product close to heat sources, in direct sunlight or next to any household appliance with strong magnetic field or electromagnetic field, such as a microwave oven or a refrigerator.
- Do not allow the product to come into contact with water, dust and chemicals.
- Protect the product from aggressive liquids and vapors.
- Do not place the product on or near any inflammable or fire-vulnerable object, such as rubber-made materials.
- Do not install the product in rooms with high humidity, for example, in bathrooms, laundry rooms and wet basements.

Safety Notes During Operation

- Use only spare parts and accessories supplied or authorized by Yealink. The operation of non- authorized parts cannot be guaranteed.
- Do not place heavy objects on top of the handset or the base station in case of damage and deformation caused by the heavy load.
- Do not open the handset or the base station by yourself for repair purpose, which could expose you to high voltages. Have all repairs carried out by authorized service personnel.
- Do not let a child operate the product without guidance.
- Keep the small accessories contained in your product out of reach of small children in case of accidental swallowing.
- Before plugging or unplugging any cable, make sure that your hands are completely dry.
- Do not hold the handset up to your ear when speakphone is on or when the ringer is ringing as the volume can be very loud, which may be harmful to your hearing.
- During a thunderstorm, stop using the product and disconnect it from the power supply to avoid lightning strike.
- If the product is left unused for a rather long time, disconnect the base station from the power supply and unplug the power adapter.
- When there is smoke emitted from the product, or some abnormal noise or smell, disconnect the product from the power supply, and unplug the power adapter immediately.
- Remove the electrical cord from an outlet by pulling gently on the power adapter, not by pulling the cord.

 **Battery Precautions**

- Do not immerse the battery into water, which could short-circuit and damage the battery.
- Do not expose the battery to an open flame or leave the battery where it could be subjected to extremely high temperatures, which could cause the battery to explode.
- Do power the handset off before removing the battery.
- Do not try to use the battery for the power supply of any device other than this handset.
- Do not open or mutilate the battery, released electrolyte is corrosive and may cause damage to the your eyes or skin.
- Use only the rechargeable battery pack delivered with the handset or those rechargeable battery packs expressly recommended by Yealink.
- Defective or exhausted battery should never be disposed of as municipal waste. Return old battery to the battery supplier, a licensed battery dealer or a designated collection facility.

 **Notices of Cleaning**

- Before cleaning the base station, stop using it and disconnect it from the power supply.
- Remove the battery before cleaning the handset to reduce risk of electric shock.
- Only clean your product with a piece of slightly moist and anti-static cloth.
- Keep the power plug clean and dry. Using a dirty or wet power plug may lead to electric shock or other perils.

Index

A

About This Guide [vii](#)
 Adding Contacts [39](#)
 Adjusting Ringer Volume [25](#)
 Advisory Tones [31](#)
 Always Forward [68](#)
 Anonymous Call [73](#)
 Anonymous Call Rejection [74](#)
 Answering Calls [64](#)
 Appendix A - Time Zones [95](#)
 Appendix B - Menu Structure [97](#)
 Appendix C- Input Modes and Characters [98](#)
 Area Code [48](#)
 Assigning a Speed Dial Number [53](#)
 Attended Transfer [69](#)
 Auto Answer [55](#)
 Auto Intercom [55](#)
 Auto Provision [57](#)

B

Backlight [32](#)
 Base Restart [56](#)
 Base Reset [56](#)
 Base Station Description [9](#)
 Basic Network Settings [21](#)
 Basic Operations [15](#)
 Battery Charging Status [7](#)
 Battery Information [6](#)
 Battery Capacity [6](#)
 Battery Disposal [7](#)
 Blacklist [41](#)
 Block Out [48](#)

C

Call Features [61](#)
 Call Forward [68](#)
 Call Hold/Resume [66](#)
 Call History Management [44](#)
 Call Mute [65](#)
 Call Transfer [68](#)
 Call Waiting [66](#)
 Charging the Handset [7](#)
 Changing a Speed Dial Number [54](#)
 Checking System Status [23](#)
 Color Schemes [32](#)
 Connecting the Base Station [4](#)
 Conference Call [70](#)
 Configuring the Input Modes [17](#)
 Configuring SCA Feature [78](#)
 Configuring Static DNS [21](#)
 Configuring Static IP Address [21](#)

Contact Management [39](#)
 Copyright [ii](#)

D

Date and Time [33](#)
 Deleting Contacts [40](#)
 Deleting a Speed Dial Number [54](#)
 Declaration of Conformity [ii](#)
 Dial Plan [45](#)
 Do Not Disturb (DND) [67](#)

E

Eco Mode+ [58](#)
 Eco Mode [58](#)
 Editing Contacts [40](#)
 Emergency Numbers [49](#)
 Ending Calls [64](#)
 Entering Data and Editing Fields [17](#)

F

Upgrading the Base Station [95](#)

G

Getting Started [1](#)
 GNU GPL Information [v](#)

H

Handset Description [10](#)
 Handset Name [30](#)
 Handset Registration [19](#)
 Handset Reset [56](#)
 Handset User Interface [14](#)

I

Icon Instructions [13](#)
 Incoming Lines [51](#)
 Information for DECT Product [iv](#)
 Important Safety Information [101](#)
 In This Guide [vii](#)
 Index [103](#)

K

Keypad Light [32](#)

L

Language [30](#)
 LCD Screen Display [12](#)
 LED Instruction [12](#)
 Local Conference [70](#)

Local Directory 39
Locating a Handset 26
Locking/Unlocking Keypad 25

M

Main Menu 15
Menu Guidance 15
Menu Structure 97

N

Network Conference 71
Notification Light 33

O

Overview 9
Outgoing Lines 50

P

Packaging Contents 1
Phone Settings 29
Placing a Call from Local Directory 41
Placing a Call Using Speed Dial Key 55
Placing Calls 61
Placing External Calls 63
Placing Internal Calls 62
Power over Ethernet 4

R

Redialing Calls 65
Registering Account 24
Regulatory Notices 101
Remote Phone Book 42
Replace Rule 46
Returning to Idle Screen 17
Repeater Mode 59
Ring Tones 31

S

Screen Saver 32
Searching for Contacts 40
Select Base Station 20
Semi-Attended Transfer 68
Setting up the Charger Cradle 7
Setting up the W52H Handset 5
Shared Call Appearance (SCA) 77
Shortcuts 38
Speed Dial 53
Submenu 16
Switching Silent Mode to On and Off 26

T

Table of Contents viii
Turning Handset On/Off 25
In This Guide vii
Troubleshooting 87

U

User Interfaces 13
Using SCA Feature on the Handset 80

V

Voice Mail 75

W

Web User Interface 14
Warranty ii
WEEE Warning iv