

Fanvil

Fanvil

Smart Video Phone Fanvil D900 User Guide



Fanvil

Fanvil

Smart Video Phone Fanvil D900 User Guide





Safety Notices

Please read the following safety notices before installing or using this phone. They are crucial for the safe and reliable operation of the device.

- Please use the external power supply that is included in the package. Other power supplies may cause damage to the phone, affect the behavior or induce noise.
- Before using the external power supply in the package, please check with home power voltage. Inaccurate power voltage may cause fire and damage.
- Please do not damage the power cord. If power cord or plug is impaired, do not use it, it may cause fire or electric shock.
- The plug-socket combination must be accessible at all times because it serves as the main disconnecting device.
- Do not drop, knock or shake it. Rough handling can break internal circuit boards.
- Do not install the device in places where there is direct sunlight. Also do not put the device on carpets or cushions. It may cause fire or breakdown.
- Avoid exposure the phone to high temperature, below 0°C or high humidity. Avoid wetting the unit with any liquid.
- Do not attempt to open it. Non-expert handling of the device could damage it. Consult your authorized dealer for help, or else it may cause fire, electric shock and breakdown.
- Do not use harsh chemicals, cleaning solvents, or strong detergents to clean it. Wipe it with a soft cloth that has been slightly dampened in a mild soap and water solution.
- When lightning, do not touch power plug or phone line, it may cause an electric shock.
- Do not install this phone in an ill-ventilated place.
- You are in a situation that could cause bodily injury. Before you work on any equipment, be aware of the hazards involved with electrical circuitry and be familiar with standard practices for preventing accidents.

Fanvil Technology Co., Ltd

HQ Add: Level 3, Block A, Gaoxinqi Building, Anhua Industrial Park, Qianjin 1 Road, 35th District, Bao'An, Shenzhen, 518101 P.R. China
Tel: +86-755-2640-2199 Fax: +86-755-2640-2618 Email: fanvil@fanvil.com www.fanvil.com Beijing Tel: +86-10-5753-6809
Suzhou Tel: +86-512-6592-0605 SEA Tel: +60-3-203-50737

Contents

Contents.....	1
Introduction	1
Smart Video Phone Fanvil D900 Overview	1
With Attachment.....	1
Phone component descriptions	2
Interface introduction.....	5
Touch Screen Description.....	7
Status Bar.....	9
Functional applications:.....	11
Update of the phone.....	12
Dsskey	14
Contact.....	17
Add new local contact	17
Add account.....	18
Creat group.....	19
Favorite.....	19
Network Phonebook	20
BlockList&CallBarring.....	21
Phone Settings	22
System info.....	22
Network	23
Network.....	23
PPPoE.....	25
QoS.....	26
Port.....	28
Stun.....	28
Account.....	29
Call	34
General.....	35
Dial plan	38
Account.....	41
Display.....	43
Tone.....	43
Time&date	44
Maintain.....	45

Fanvil Technology Co., Ltd

HQ Add: Level 3, Block A, Gaoxinqi Building, Anhua Industrial Park, Qianjin 1 Road, 35th District, Bao'An, Shenzhen, 518101 P.R. China
Tel: +86-755-2640-2199 Fax: +86-755-2640-2618 Email: fanvil@fanvil.com www.fanvil.com Beijing Tel: +86-10-5753-6809
Suzhou Tel: +86-512-6592-0605 SEA Tel: +60-3-203-50737

Service port.....	45
CWMP set.....	46
Backup.....	47
Update.....	48
Audio.....	49
Audio.....	49
Audio param.....	50
Video.....	51
Video param.....	51
Bandwidth.....	52
Softkey.....	53
MCAST.....	54
Reboot.....	55
Call Service.....	55
Register.....	55
Outgoing & Incoming call.....	56
Video Call.....	56
Blind Transfer.....	57
Semi-attended Transfer.....	58
Attended Transfer.....	59
Conference Call.....	59
Call Hold.....	60
Android Settings.....	61
Ethernet configuration.....	61
Security.....	61
Language&Input.....	62
Web Settings.....	62
Logon.....	62
Network.....	63
QoS & VLAN.....	63
Service Port.....	65
Registration.....	67
Dial Plan.....	68
Basic Settings.....	68
Dial Plan Add.....	69
Security.....	72

Fanvil Technology Co., Ltd

HQ Add: Level 3, Block A, Gaoxinqi Building, Anhua Industrial Park, Qianjin 1 Road, 35th District, Bao'An, Shenzhen, 518101 P.R. China
Tel: +86-755-2640-2199 Fax: +86-755-2640-2618 Email: fanvil@fanvil.com www.fanvil.com Beijing Tel: +86-10-5753-6809
Suzhou Tel: +86-512-6592-0605 SEA Tel: +60-3-203-50737

Introduction

Thank you for purchasing the D900 Android smart video phone. The D900 is a fully featured video phone that provides voice and video communication over the data network. This phone has all the features of a traditional telephone and all gives access to many data service features. This guide will help you easily use the various features and services available on your phone.

Smart Video Phone Fanvil D900 Overview



With Attachment

Item	Function
------	----------

Fanvil Technology Co., Ltd

HQ Add: Level 3, Block A, Gaoxinqi Building, Anhua Industrial Park, Qianjin 1 Road, 35th District, Bao'An, Shenzhen, 518101 P.R. China
Tel: +86-755-2640-2199 Fax: +86-755-2640-2618 Email: fanvil@fanvil.com www.fanvil.com Beijing Tel: +86-10-5753-6809
Suzhou Tel: +86-512-6592-0605 SEA Tel: +60-3-203-50737

Power Adapter	Power supply for telephone.
Network Cable	Used to access network for the phone.
Handset	Make phone calls with the phone's basic functions.
Handset Line	Connected with the Handset and the phone.









Phone component descriptions



Phone elements icon

Fanvil Technology Co., Ltd

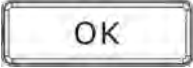
HQ Add: Level 3, Block A, Gaoxinqi Building, Anhua Industrial Park, Qianjin 1 Road, 35th District, Bao'An, Shenzhen, 518101 P.R. China
Tel: +86-755-2640-2199 Fax: +86-755-2640-2618 Email: fanvil@fanvil.com www.fanvil.com Beijing Tel: +86-10-5753-6809
Suzhou Tel: +86-512-6592-0605 SEA Tel: +60-3-203-50737

Key	Function
	Search key. Tap the key and you can enter the search interface.
	Option key. You can browse and accomplish all functions of the phone through pressing this key. Also, you can press and hold this key to complete screenshot.
	Return key. Press this button in the detailed interface, it will return to the previous interface; If it is pressed in the application program interface, the current program will be closed.
	Home key. Press this key, the phone will return to the idle screen.
	Volume control key. Turn down or turn up all kinds of volume by pressing these two keys.
	Mute key. In the call mode, press this key in calling mode, you can hear the other side, and the other side cannot hear you; press this button again to leave this mode. When the phone call is ringing, press this button to turn off the ring tips.
	Confirm key. Click the OK key to enter the selected program or contact details.
	Delete key. You can delete the erroneous input or contact.
	R/Send key. Use the key to dial the last call number. It also could be used to make a phone call by sending a

Fanvil Technology Co., Ltd

HQ Add: Level 3, Block A, Gaoxing Building, Anhua Industrial Park, Qianjin 1 Road, 35th District, Bao'An, Shenzhen, 518101 P.R. China
 Tel: +86-755-2640-2199 Fax: +86-755-2640-2618 Email: fanvil@fanvil.com www.fanvil.com Beijing Tel: +86-10-5753-6809
 Suzhou Tel: +86-512-6592-0605 SEA Tel: +60-3-203-50737

phone number.

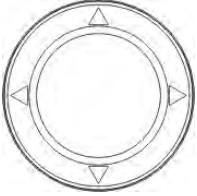

Navigation key.



Menu key. Press it enter or exit the app interface.



Phone book. Tap to enter the contacts interface.



Call log. Tap to see call logs.



Headset key. Click it enter the dial interface when the phone is in desktop, receive the call using headset mode or switch the call to headset mode during a call.



Digital keyboard.



The hands-free key.



The camera.



Fanvil Technology Co., Ltd

HQ Add: Level 3, Block A, Gaoxinqi Building, Anhua Industrial Park, Qianjin 1 Road, 35th District, Bao'An, Shenzhen, 518101 P.R. China
Tel: +86-755-2640-2199 Fax: +86-755-2640-2618 Email: fanvil@fanvil.com www.fanvil.com Beijing Tel: +86-10-5753-6809
Suzhou Tel: +86-512-6592-0605 SEA Tel: +60-3-203-50737

Interface introduction

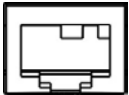

Interface illustration picture 1

	Name	Meaning
	SD Card interface	Connect SD Card for saving data.
	DC Power Interface	Input: 220V AC Output: 12V DC
	PC interface	Specification RJ45, connect it computer.

Fanvil Technology Co., Ltd

HQ Add: Level 3, Block A, Gaoxinqi Building, Anhua Industrial Park, Qianjin 1 Road, 35th District, Bao'An, Shenzhen, 518101 P.R. China
 Tel: +86-755-2640-2199 Fax: +86-755-2640-2618 Email: fanvil@fanvil.com www.fanvil.com Beijing Tel: +86-10-5753-6809
 Suzhou Tel: +86-512-6592-0605 SEA Tel: +60-3-203-50737

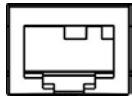

Internet interface

Specification RJ45, connect it to network.

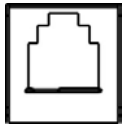

Handset interface

Specification RJ9, used to connect the Handset to the phone.



Interface illustration picture 2

Name

Meaning



USB interface.

Connect it to USB disk.

Fanvil Technology Co., Ltd

HQ Add: Level 3, Block A, Gaoxinqi Building, Anhua Industrial Park, Qianjin 1 Road, 35th District, Bao'An, Shenzhen, 518101 P.R. China
 Tel: +86-755-2640-2199 Fax: +86-755-2640-2618 Email: fanvil@fanvil.com www.fanvil.com Beijing Tel: +86-10-5753-6809
 Suzhou Tel: +86-512-6592-0605 SEA Tel: +60-3-203-50737

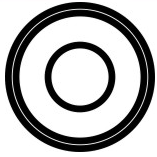

Headset interface.



Connect the Headset.
Headset standard: 3.5mm.



HDMI interface.

Interface for high-definition audio and video. A-A interface, A to A interface.

• **Note:**

1. Put the handset line into the handset interface according to the interface illustration.
2. Plug the power adapter into the DC port; poke the other side of the power adapter into an electric socket.
3. Insert one end of RJ45 network cable into the phone's WAN port (Please refer to the interface illustration picture 1) and put the other end into the network equipment. After that, if the network connection status on the status bar is displayed as , actions such as making some telephone calls and surfing the internet could be done. If the network connection status on the status bar is displayed as , please verify whether the network was configured correctly and the network cable was plugged in correctly.

Touch Screen Description

You can touch the screen manually to complete the corresponding operation. Here are three ways to use:

Click: Any icon or button can be clicked to realize its function.

Fanvil Technology Co., Ltd

HQ Add: Level 3, Block A, Gaoxingqi Building, Anhua Industrial Park, Qianjin 1 Road, 35th District, Bao'An, Shenzhen, 518101 P.R. China
Tel: +86-755-2640-2199 Fax: +86-755-2640-2618 Email: fanvil@fanvil.com www.fanvil.com Beijing Tel: +86-10-5753-6809
Suzhou Tel: +86-512-6592-0605 SEA Tel: +60-3-203-50737



Touch screen:

- Press and hold the standby interface will pop-up choice wallpaper desktop option box, you can according to the prompt to change the wallpaper.
- Support full multi-touch.

Slide:

Slide your finger on the screen upward or downward slowly to move the interface on the screen.

On some kinds of screen such as idle desktop, you can switch the desktop just by moving your fingers on the screen to left or right. Dragging your finger to slide will not select or activate anything on the screen.

You can just wait or gently press any place of the screen to stop the sliding after your finger rapidly sliding on the screen. Gently pressing or touching to stop the scrolling will not select or activate anything on the screen.







Fanvil Technology Co., Ltd

HQ Add: Level 3, Block A, Gaoxingqi Building, Anhua Industrial Park, Qianjin 1 Road, 35th District, Bao'An, Shenzhen, 518101 P.R. China
Tel: +86-755-2640-2199 Fax: +86-755-2640-2618 Email: fanvil@fanvil.com www.fanvil.com Beijing Tel: +86-10-5753-6809
Suzhou Tel: +86-512-6592-0605 SEA Tel: +60-3-203-50737

Status Bar







All of the status information about D900 is displayed on the top of the screen. You can click on the notification icon in the left of the status bar or drag down the drop-down list with your fingers to enter the notification panel to further review and deal with all of the information.

Note:The right icon of the status bar can't be drag, just the left can.

Status bar	Meaning
 Handset mode	Indicates that the phone is in the handset mode.
 Headset mode	Indicates that the phone is in the headset mode.
 Silent mode	Shows that the phone is in silent mode. This mode can be canceled by directly clicking the mute button when the screen is in the idle interface.
 Hands-free mode	Indicates that the call is in hands-free status.
 Alarm clock	If you set an alarm clock, the alarm clock icon will display on the status bar.
 Network status (successful)	Displays that the network connection is successful. Tap the icon directly into the network settings.
 Network status (failed)	Shows that the network connected failed. You need to check the network is

Fanvil Technology Co., Ltd

HQ Add: Level 3, Block A, Gaoxingqi Building, Anhua Industrial Park, Qianjin 1 Road, 35th District, Bao'An, Shenzhen, 518101 P.R. China
 Tel: +86-755-2640-2199 Fax: +86-755-2640-2618 Email: fanvil@fanvil.com www.fanvil.com Beijing Tel: +86-10-5753-6809
 Suzhou Tel: +86-512-6592-0605 SEA Tel: +60-3-203-50737

		properly connected and the parameters are configured correctly.
	SD card	Displays that the phone successfully identifies the USB device. Tap the icon directly to switch into the USB application wizard.
	Missed calls	Shows that there are several missed calls. You can click on the icon directly to switch into the call log.
	Open the DND	Shows that the phone is on “Do Not Disturb” mode. Any of the call could be directly rejected before it’s ring interface appears. There is only a missed call icon leaving in the status bar.
	Call forward	Shows that the call forward function is opened.
	Auto answer	Shows that the auto answer function is opened.
	Black list	If a phone number is added to the firewall, then open the firewall function, all calls about this phone number could be rejected directly.
	New record	Indicates that there are several new

Fanvil Technology Co., Ltd

HQ Add: Level 3, Block A, Gaoxinqi Building, Anhua Industrial Park, Qianjin 1 Road, 35th District, Bao'An, Shenzhen, 518101 P.R. China
 Tel: +86-755-2640-2199 Fax: +86-755-2640-2618 Email: fanvil@fanvil.com www.fanvil.com Beijing Tel: +86-10-5753-6809
 Suzhou Tel: +86-512-6592-0605 SEA Tel: +60-3-203-50737

unread phone recordings.

Functional applications:



Phone

Click this icon, and it will switch to pre-dial interface. You can make some phone calls through the screen or keyboard.



Email

Has the function of sending and receiving e-mail. When an account has been configured successfully, you can send and receive your e-mail on the phone and this account will automatically sync the contacts to the mailbox account.



Settings

It contains System, Network, Account, Call, Display and so on. You can configure some settings.



Contacts

Support functions such as search, add, remove and edit.



Android settings

It contains the Call settings, Basic settings, Advanced settings, VOIP and so on, you can configure some settings in the corresponding menu. (Android system settings)



Message

Like the phone, with messages to write, read and send function.



MWI

All calls will be transferred into voice mail when the MWI is enabled.

Fanvil Technology Co., Ltd

HQ Add: Level 3, Block A, Gaoxingqi Building, Anhua Industrial Park, Qianjin 1 Road, 35th District, Bao'An, Shenzhen, 518101 P.R. China
Tel: +86-755-2640-2199 Fax: +86-755-2640-2618 Email: fanvil@fanvil.com www.fanvil.com Beijing Tel: +86-10-5753-6809
Suzhou Tel: +86-512-6592-0605 SEA Tel: +60-3-203-50737



Enter into the calendar and you can view the accurate date.

Calendar



Enter the call log and you can view all call records. You can also view the "Incoming Calls", "Outgoing Calls" and "Missed Calls" records by pressing the Option key.

Call log



Have export contacts, add blacklists and outgoing call barring functions.

Import and Export Management



Connect ppoe.

PPPOE

Update of the phone

Please contact with service provider to get the new version to upgrade.

Strongly recommended:

- 1) Before the upgrade the new version, please send personal data backup to mobile devices, to prevent accidental loss.
- 2) Once the upgrade process, please do not power blackout, equipment may not be able to start.

Auto provision: Keep phone registered successfully and configure parameters about automatic updates such as server address, upgrade file name, time interval and so on. And then the phone will check for updates from the server at a fixed time intervals and upgrade

Fanvil Technology Co., Ltd

HQ Add: Level 3, Block A, Gaoxingqi Building, Anhua Industrial Park, Qianjin 1 Road, 35th District, Bao'An, Shenzhen, 518101 P.R. China
Tel: +86-755-2640-2199 Fax: +86-755-2640-2618 Email: fanvil@fanvil.com www.fanvil.com Beijing Tel: +86-10-5753-6809
Suzhou Tel: +86-512-6592-0605 SEA Tel: +60-3-203-50737

itself. See the specific automatically upgrade instructions, please switch to Update.

Manual upgrade----- USB: Will upgrade package in U disk and inserted the U disk into the USB interface (the content of the need to be updated). Before the phone restart, at the same time hold down the "hands-free sets" and "headset button", then insert the power supply and will enter the unit at this time to Recovery mode, you can see under the Recovery operation menu, shown below:

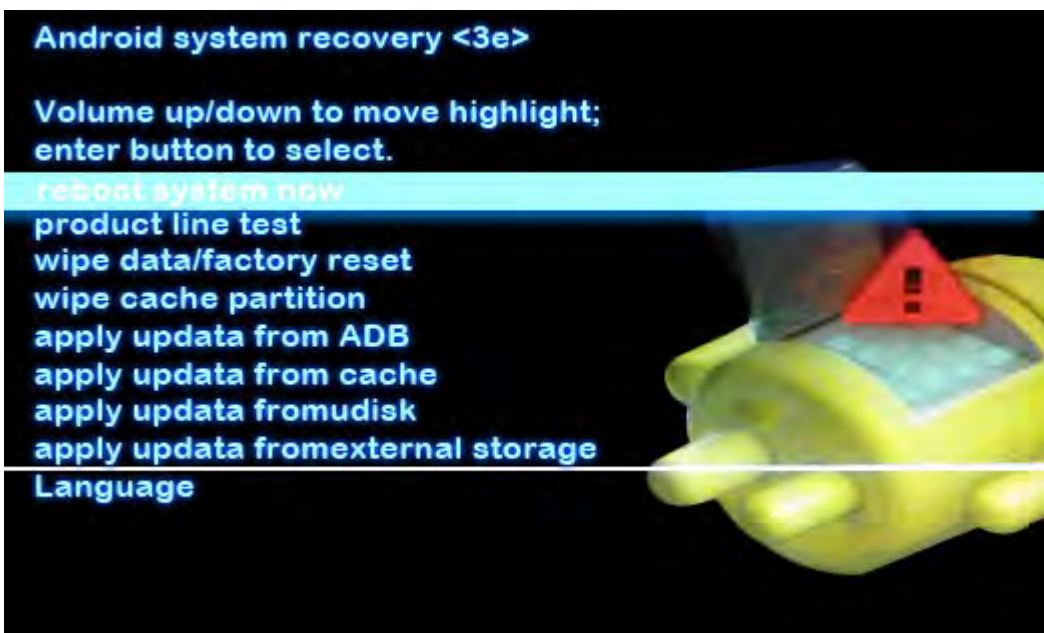

Through the hard on the keyboard “navigation button”, “backspace”, “enter”, to operate on the Recovery menu.

Select “apply update from udisk” or “apply update from external storage” (SD card), enter the sub-directory and select the upgrade packages, click on “OK” key to start upgrade .After the success of the upgrade, there will be prompt on interface, the user can immediately return to the main menu select “reboot system now” to restart the system to start using the new version.

Fanvil Technology Co., Ltd

HQ Add: Level 3, Block A, Gaoxingqi Building, Anhua Industrial Park, Qianjin 1 Road, 35th District, Bao'An, Shenzhen, 518101 P.R. China
Tel: +86-755-2640-2199 Fax: +86-755-2640-2618 Email: fanvil@fanvil.com www.fanvil.com Beijing Tel: +86-10-5753-6809
Suzhou Tel: +86-512-6592-0605 SEA Tel: +60-3-203-50737

Notes: In some cases after upgrading, in order to avoid new and old version data of incompatible problems, needs to remove user data and system cache (the so-called double wiper) whether you need specific clear, please refer to the Release Note.

Web Update :

Input the phone's IP on the web;

Input the user name and password to phone's web;

Enter "MAINTENANCE"—"UPDATE";

Click the button "Browser" to select the image on your PC and click the button "Update";

Waiting, the system will be update success.

Dsskey

Introduction : This module contains five expansion module, 140 editable key. You can click "edit" or press and hold the key to edit it. Line1~6 and release are the default keys, but you can also edit them. Like the below picture:



Fanvil Technology Co., Ltd

HQ Add: Level 3, Block A, Gaoxing Building, Anhua Industrial Park, Qianjin 1 Road, 35th District, Bao'An, Shenzhen, 518101 P.R. China
Tel: +86-755-2640-2199 Fax: +86-755-2640-2618 Email: fanvil@fanvil.com www.fanvil.com Beijing Tel: +86-10-5753-6809
Suzhou Tel: +86-512-6592-0605 SEA Tel: +60-3-203-50737

Type	Meaning
Memory Key	Clicking on the button you can dial the mapped number directly.
	Subscribe : BLF 、 Presence 、 Speed Dial and Intercom
	Pickup number :the number which server set。
	Pickup :That is, when A calls B, B ringing but no one answered the call, C could dial a number which is comprised of specified prefix and B's number, and then C can talk with A.
	BLF :It used to prompt you the state of the subscribe user, and that could pick up the subscribed number by the state. BLF help you monitor the state of subscribe user (idle, ringing, a call).
	Presence :Compared to BLF, the Presence is also able to view whether the user is online. Note: You cannot subscribe the same number for BLF and Presence at the same time
	Speed dial :You can call the number directly which you set. This feature is convenient for you to dial the number which you frequently dialed.
Intercom :This feature allows the operator or the secretary to connect the phone quickly; it is widely used in office environments.	
Line	The button map the sip line, it enter the dial pad and light the default sip line when you click the button.
	The button map some Key Event。
Key Event	Title : Consistent with the subscription name Subtype : Some basic keys
DTMF	It maps the keypad of the phone, allowing you to edit the dialed number or input numbers during a call.

Fanvil Technology Co., Ltd

HQ Add: Level 3, Block A, Gaoxingqi Building, Anhua Industrial Park, Qianjin 1 Road, 35th District, Bao'An, Shenzhen, 518101 P.R. China
Tel: +86-755-2640-2199 Fax: +86-755-2640-2618 Email: fanvil@fanvil.com www.fanvil.com Beijing Tel: +86-10-5753-6809
Suzhou Tel: +86-512-6592-0605 SEA Tel: +60-3-203-50737

URL It maps the website; click it to open the URL directly.

Multicast It maps the Multicast; you can click it to make a multicast.



The LED status of BLF

LED Status	Description
Steady green	The object is idle.
Slow blinking red	The object is ringing.
Steady red	The object is active.
Fast blinking red	The object has failed.
Steady orange	The subscribed number is in a call with current line.
Off	Not subscribed.

The LED status of Presence

LED Status	Description
------------	-------------

Fanvil Technology Co., Ltd

HQ Add: Level 3, Block A, Gaoxinqi Building, Anhua Industrial Park, Qianjin 1 Road, 35th District, Bao'An, Shenzhen, 518101 P.R. China
 Tel: +86-755-2640-2199 Fax: +86-755-2640-2618 Email: fanvil@fanvil.com www.fanvil.com Beijing Tel: +86-10-5753-6809
 Suzhou Tel: +86-512-6592-0605 SEA Tel: +60-3-203-50737

Steady green	The object is online.
Slow blinking red	The object is ringing.
Steady red	The object is active.
Fast blinking red	The object has failed.
Off	Not subscribed.

Note: Please set Type first, then set subtype and value base on the introduction.

You can select value from contacts by clicking the contact icon. Save the configuration and click complete in right side.

You can delete the dsskey by the same method, edit->clear->save->complete.

Contact

Add new local contact

1. Tap the contacts button.
2. Tap “+” in the upper-right corner.
3. Select “Keep Locally”.



4. Add a picture for a contact. Tap  into the picture selection interface to select photos in your list of photos when editing contacts. It will automatically return to the editing interface after you save it. If you want to change the picture, tap the Contacts icon to select "use this photo", "delete the icon" or "change the icon".
5. You can click the little arrow to expand the name what you want to edit.
6. Follow the prompts to complete the edit contacts, you can also select save to Dsskey. Click “Done” to save it.

Fanvil Technology Co., Ltd

HQ Add: Level 3, Block A, Gaoxinqi Building, Anhua Industrial Park, Qianjin 1 Road, 35th District, Bao'An, Shenzhen, 518101 P.R. China
Tel: +86-755-2640-2199 Fax: +86-755-2640-2618 Email: fanvil@fanvil.com www.fanvil.com Beijing Tel: +86-10-5753-6809
Suzhou Tel: +86-512-6592-0605 SEA Tel: +60-3-203-50737

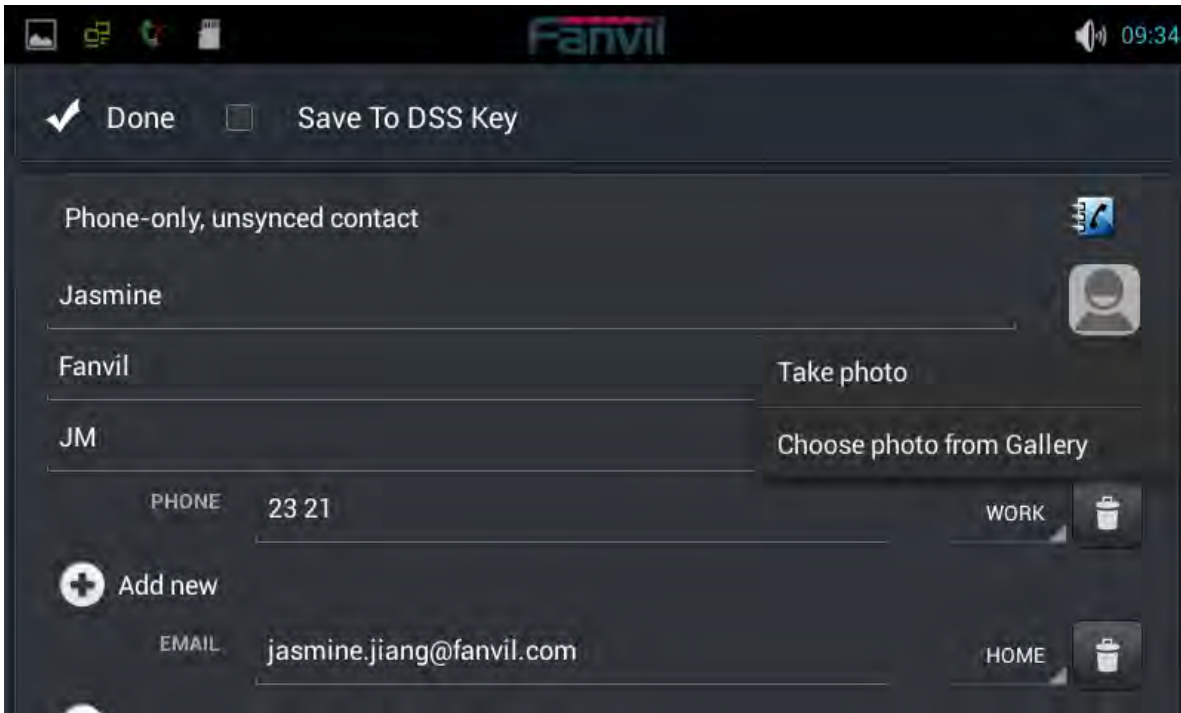

Add account

1. Tap the contact button;
2. Tap “+” in the upper-right corner.
3. Select “Add account”.
4. Edit exchange account and follow the prompts to complete the editing.

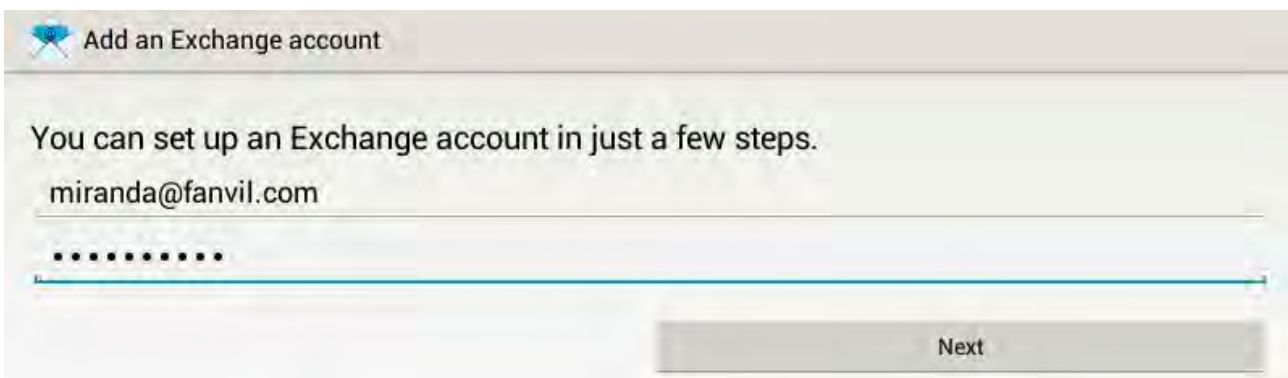

Fanvil Technology Co., Ltd

HQ Add: Level 3, Block A, Gaoxingqi Building, Anhua Industrial Park, Qianjin 1 Road, 35th District, Bao'An, Shenzhen, 518101 P.R. China
Tel: +86-755-2640-2199 Fax: +86-755-2640-2618 Email: fanvil@fanvil.com www.fanvil.com Beijing Tel: +86-10-5753-6809
Suzhou Tel: +86-512-6592-0605 SEA Tel: +60-3-203-50737

Creat group

1. Tap the “Group” button;
2. Click “+” in the upper-right corner;
3. You can select “Create local group” or “Create account group”;
4. Edit group name, then pick members from contact list;
5. Click “Done” to save the group.

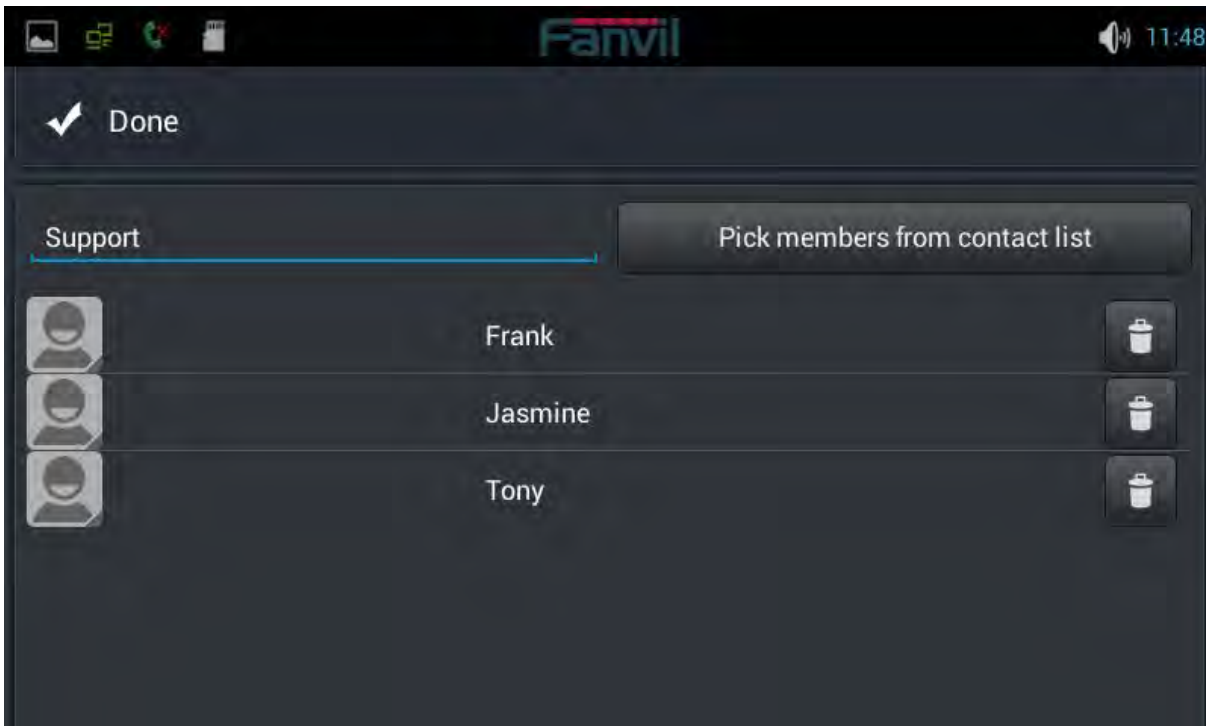

Favorite

1. Tap the “Favorite” button;

2. Select the contacts what you want to set, or click  to select all the contacts.

3. Click confirm to save them.

Fanvil Technology Co., Ltd

HQ Add: Level 3, Block A, Gaoxinqi Building, Anhua Industrial Park, Qianjin 1 Road, 35th District, Bao'An, Shenzhen, 518101 P.R. China
Tel: +86-755-2640-2199 Fax: +86-755-2640-2618 Email: fanvil@fanvil.com www.fanvil.com Beijing Tel: +86-10-5753-6809
Suzhou Tel: +86-512-6592-0605 SEA Tel: +60-3-203-50737

Network Phonebook

Set the remote phonebook

1. Click the edit icon in the upper-right;
2. Click URL;
3. Follow the prompts to fill in the information.
4. Click “Done” to save it.

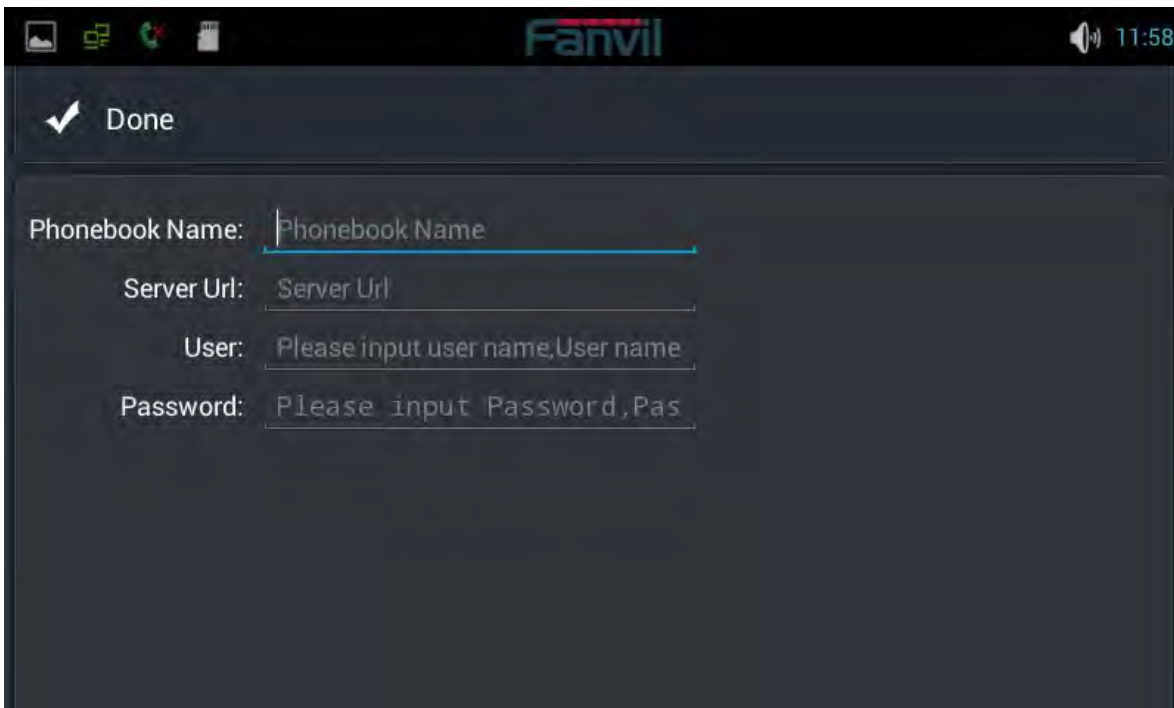

Done

Phonebook Name:

Server Url:

User:

Password:

Set the LDAP

1. Click the edit icon in the upper-right;
2. Click LDAP;
3. Edit the information following the prompts;
4. Click “Done” to save it.

Fanvil Technology Co., Ltd

HQ Add: Level 3, Block A, Gaoxinqi Building, Anhua Industrial Park, Qianjin 1 Road, 35th District, Bao'An, Shenzhen, 518101 P.R. China
Tel: +86-755-2640-2199 Fax: +86-755-2640-2618 Email: fanvil@fanvil.com www.fanvil.com Beijing Tel: +86-10-5753-6809
Suzhou Tel: +86-512-6592-0605 SEA Tel: +60-3-203-50737

Done

Display Title: Fanvil-BJ Use SSL:

Server Address: 172.16.1.3 Server Port: 389

Authentication: DIGEST-MD5

Username: may Password:

Search Base: dc=winline,dc=com

Telephone: telephoneNumber Mobile: mobile

Other: other Display Name: cn sn ou

Enable calling search:

Name	Phone Number	Action
chrissie 姜瑞	4130	
xinyu 宋聚坡	4060	
Test TestSn	4060	
Test TestSn	4060	
adelle.tony 王琦 test	21971	

BlockList&CallBarring

You can enable Blacklist, click the “+” to add number or contacts what you want. Using the same method to set the whitelist and CallBarring.

Fanvil Technology Co., Ltd

HQ Add: Level 3, Block A, Gaoxingqi Building, Anhua Industrial Park, Qianjin 1 Road, 35th District, Bao'An, Shenzhen, 518101 P.R. China
 Tel: +86-755-2640-2199 Fax: +86-755-2640-2618 Email: fanvil@fanvil.com www.fanvil.com Beijing Tel: +86-10-5753-6809
 Suzhou Tel: +86-512-6592-0605 SEA Tel: +60-3-203-50737

Phone Settings

System info

Tapping "Settings" can directly enter the default window "System info". It displays the current system information state.

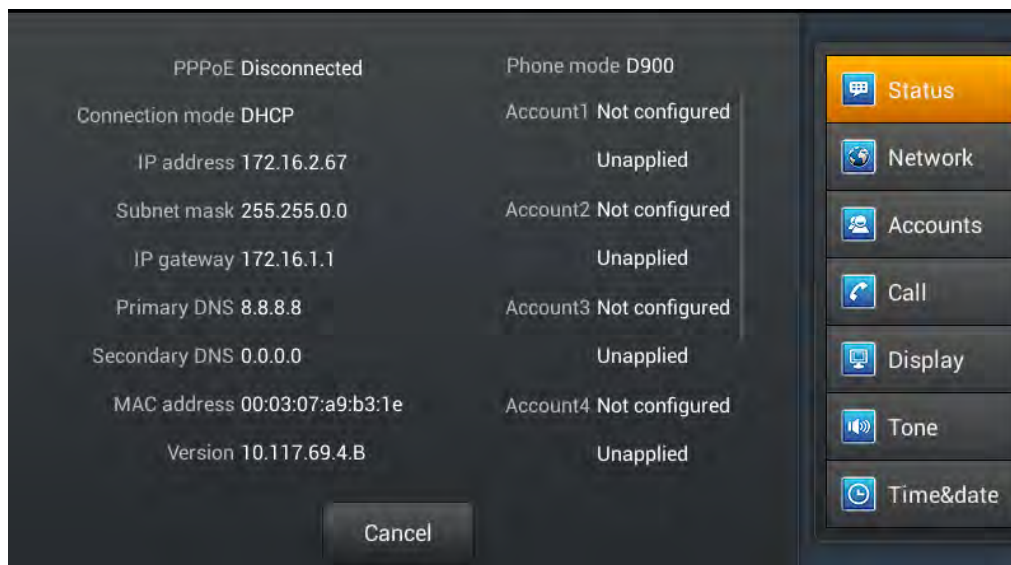

System info interface

Configuration item	Meaning
PPPoE	Displays the connection status of the PPPoE, there are three display states : Disabled、 Connecting and the IP address.
Connect mode	Displays the selected network mode, DHCP or Static IP.
IP address	Displays the IP address of the current network model.

Fanvil Technology Co., Ltd

HQ Add: Level 3, Block A, Gaoxingqi Building, Anhua Industrial Park, Qianjin 1 Road, 35th District, Bao'An, Shenzhen, 518101 P.R. China
 Tel: +86-755-2640-2199 Fax: +86-755-2640-2618 Email: fanvil@fanvil.com www.fanvil.com Beijing Tel: +86-10-5753-6809
 Suzhou Tel: +86-512-6592-0605 SEA Tel: +60-3-203-50737

Subnet mask	Displays the Subnet Mask of the current network model.
IP Gateway	Displays the default gateway of the current network model.
Primary DNS	Displays the primary DNS server address of the current network model.
Secondary DNS	Displays the standby DNS server address of the current use of the network model.
MAC address	Displays the current MAC address.
Version	Displays the current version of the phone.
Phone mode	Displays the current phone model.
Account	Displays the current configuration of the Accounts and more detailed information will be displayed on the desktop widget.

Network

Network

Tap "Network"----> "WAN mode" interface, the default interface is "DHCP": click "Save" button to save successfully after the configuration of each interface is finished. Then a tip box "Config saved" will be shown.

Fanvil Technology Co., Ltd

HQ Add: Level 3, Block A, Gaoxinqi Building, Anhua Industrial Park, Qianjin 1 Road, 35th District, Bao'An, Shenzhen, 518101 P.R. China
Tel: +86-755-2640-2199 Fax: +86-755-2640-2618 Email: fanvil@fanvil.com www.fanvil.com Beijing Tel: +86-10-5753-6809
Suzhou Tel: +86-512-6592-0605 SEA Tel: +60-3-203-50737

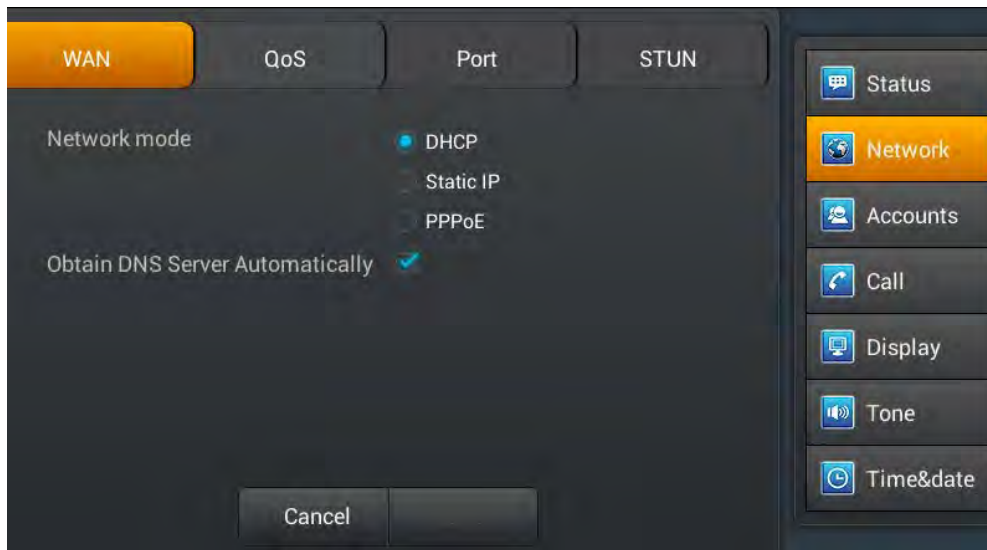

DHCP interface

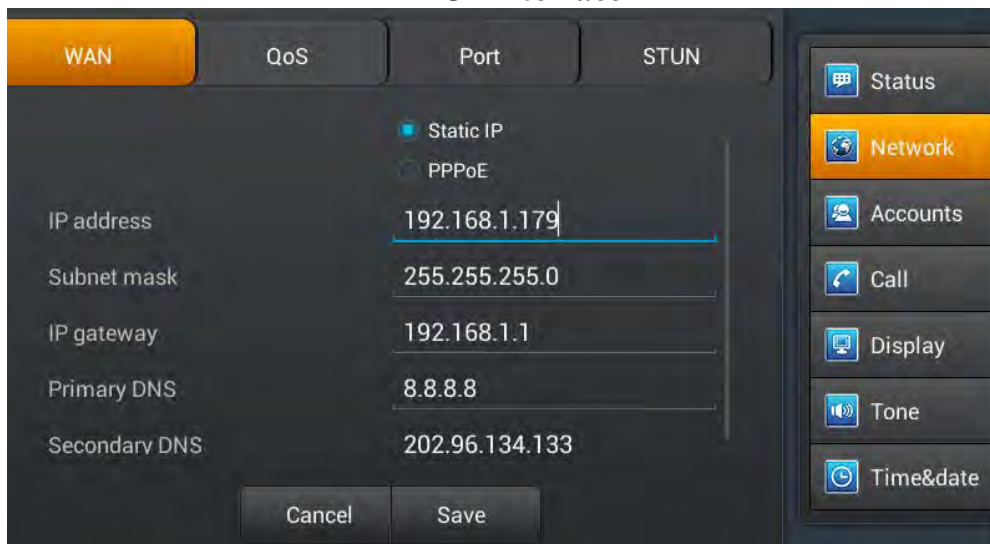

Static IP interface

Configuration	Meaning
DHCP	You can select to use DHCP, which means whether Use the DNS to connect network assigned by the DHCP server.
Static IP	IP address: Input your assigned IP address.

Fanvil Technology Co., Ltd

HQ Add: Level 3, Block A, Gaoxingqi Building, Anhua Industrial Park, Qianjin 1 Road, 35th District, Bao'An, Shenzhen, 518101 P.R. China
 Tel: +86-755-2640-2199 Fax: +86-755-2640-2618 Email: fanvil@fanvil.com www.fanvil.com Beijing Tel: +86-10-5753-6809
 Suzhou Tel: +86-512-6592-0605 SEA Tel: +60-3-203-50737

Subnet mask: Input your assigned subnet mask.

IP gateway: Input your assigned gateway.

Primary DNS: Input your assigned DNS server address.

Secondary DNS: Input your assigned Alert DNS server address.

PPPoE

Tap "Network" ----> "PPPoE". After configuring the parameters, you can click "Save" button to save.

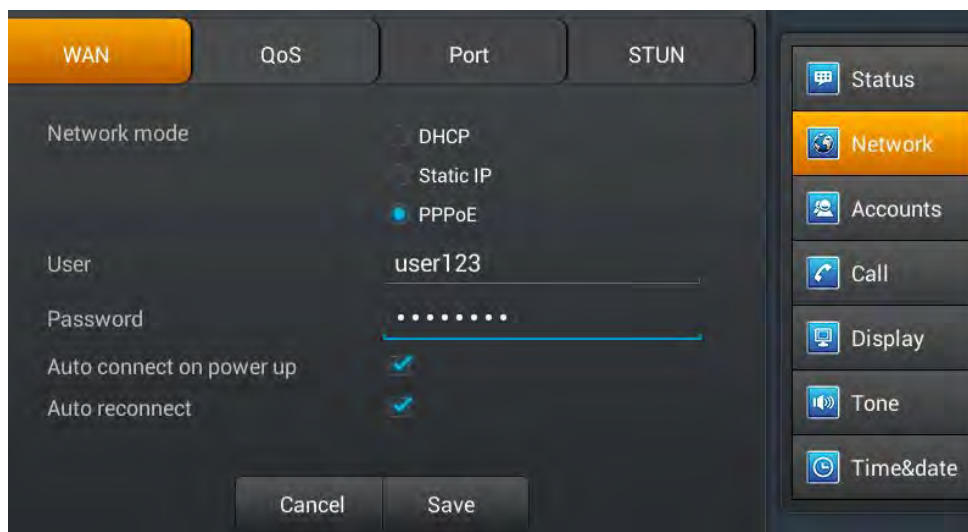

PPPoE interface

Configuration	Meaning
PPPoE	<p>User: Input your assigned PPPoE Username.</p> <p>Password: Input your assigned PPPoE Password.</p> <p>Auto connect on power up: Whether to</p>

Fanvil Technology Co., Ltd

HQ Add: Level 3, Block A, Gaoxinqi Building, Anhua Industrial Park, Qianjin 1 Road, 35th District, Bao'An, Shenzhen, 518101 P.R. China
 Tel: +86-755-2640-2199 Fax: +86-755-2640-2618 Email: fanvil@fanvil.com www.fanvil.com Beijing Tel: +86-10-5753-6809
 Suzhou Tel: +86-512-6592-0605 SEA Tel: +60-3-203-50737

automatically connect PPPoE on power up.

Auto reconnect: When connecting failed whether to automatically connect PPPoE.

QoS

Tap "Network"----> "QoS", after selecting or modifying the default settings click the "Save" button to save



QoS-DSCP Settings

DSCP is one standard of QoS. It can set the priority of Voice, Video and Signal.

Configuration item	Meaning
QoS- DSCP	Enable DSCP: Enable/Disable DSCP.
	Voice DSCP: Set the number of Voice DSCP.
	Video DSCP: Set the number of Video DSCP.
	Signal DSCP: Set the number of Signal DSCP.

Fanvil Technology Co., Ltd

HQ Add: Level 3, Block A, Gaoxingqi Building, Anhua Industrial Park, Qianjin 1 Road, 35th District, Bao'An, Shenzhen, 518101 P.R. China
 Tel: +86-755-2640-2199 Fax: +86-755-2640-2618 Email: fanvil@fanvil.com www.fanvil.com Beijing Tel: +86-10-5753-6809
 Suzhou Tel: +86-512-6592-0605 SEA Tel: +60-3-203-50737

Slide down the screen to the QoS-WAN VLAN page.

VLAN is Virtual Local Area Network.

Enable VLAN, then you can set VLAN ID, the range of ID number is 0~4095; you can also set the priority of 802.1p, the range is 0~7.

Note: You must enable DSCP if you want to set 802.1P priority.

Configuration item	Meaning
QoS- WAN VLAN	Enable WAN port VLAN: Enable/Disable WAN port VLAN.
	WAN port VLAN ID: Set the number of VLAN ID.
	SIP 802.1P priority: Set the priority number of SIP 802.1p priority.

Slide down the screen to QoS-Port VLAN interface

Port VLAN is based on port VLAN, in the same VLAN port to communicate with each other.

Configuration item	Meaning
QoS- Port VLAN	Port VLAN mode: Select the status of LAN Port VLAN.
	➤ Follow WAN: Follow the ID number of WAN.
	➤ Disable: Disable Port VLAN.
	➤ Enable: Enable Port VLAN and you can set the LAN Port VLAN ID different from WAN.
	LAN port VLAN ID: Set the number of LAN Port VLAN ID.

Fanvil Technology Co., Ltd

HQ Add: Level 3, Block A, Gaoping Building, Anhua Industrial Park, Qianjin 1 Road, 35th District, Bao'An, Shenzhen, 518101 P.R. China
 Tel: +86-755-2640-2199 Fax: +86-755-2640-2618 Email: fanvil@fanvil.com www.fanvil.com Beijing Tel: +86-10-5753-6809
 Suzhou Tel: +86-512-6592-0605 SEA Tel: +60-3-203-50737

Port

Tap "Network" ----> "Port", after selecting or modifying the default settings click "Save" button to save.

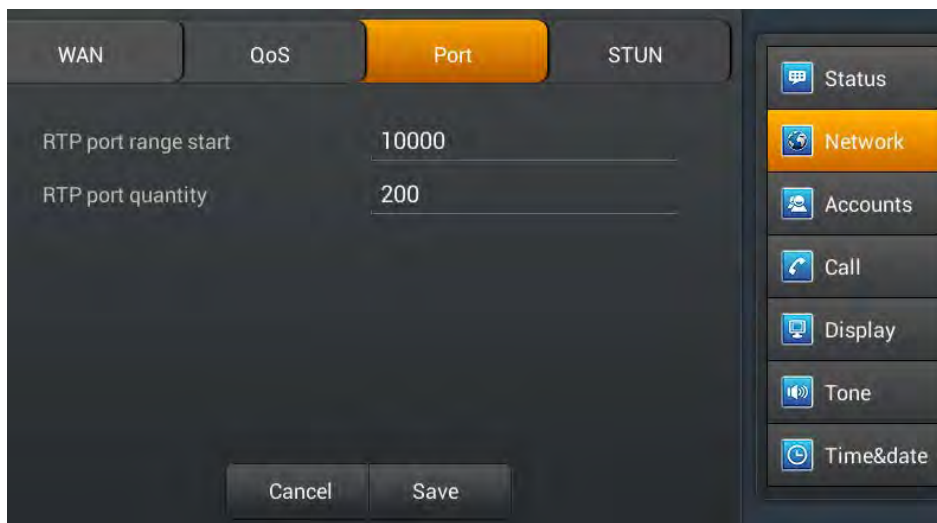

Port Settings

Configuration item	Meaning
Port	<p>RTP port range start(10000-60000): Set the telephone's RTP start port. This port is distributed to dynamic allocation.</p> <p>RTP port quantity: Set the maximum number of allocated RTP port. The default is 200.</p>

Stun

Tap "Network" ----> "Stun", after selecting or modifying the default settings click "Save" button to save.

Fanvil Technology Co., Ltd

HQ Add: Level 3, Block A, Gaoxinqi Building, Anhua Industrial Park, Qianjin 1 Road, 35th District, Bao'An, Shenzhen, 518101 P.R. China
 Tel: +86-755-2640-2199 Fax: +86-755-2640-2618 Email: fanvil@fanvil.com www.fanvil.com Beijing Tel: +86-10-5753-6809
 Suzhou Tel: +86-512-6592-0605 SEA Tel: +60-3-203-50737

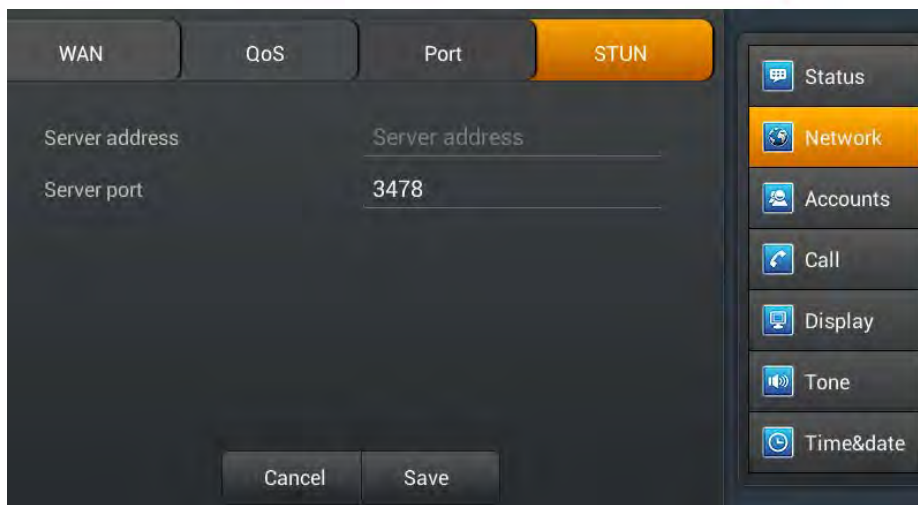

STUN interface

Configuration item	Meaning
STUN	<p>Server address: Configure the SIP STUN server address.</p> <p>Server port: Configure the SIP STUN server port .The default is 3478.</p>

Account

Tap "Accounts"---->"Account1", the default password is 123456, you can slide down to set more parameters follow the prompts , after all the parameters are set, you can click "Save" button to save.

(Note: The Account1, 2, 3, 4 ,5,6 has the same settings.)

Fanvil Technology Co., Ltd

HQ Add: Level 3, Block A, Gaoxinqi Building, Anhua Industrial Park, Qianjin 1 Road, 35th District, Bao'An, Shenzhen, 518101 P.R. China
 Tel: +86-755-2640-2199 Fax: +86-755-2640-2618 Email: fanvil@fanvil.com www.fanvil.com Beijing Tel:+86-10-5753-6809
 Suzhou Tel: +86-512-6592-0605 SEA Tel: +60-3-203-50737

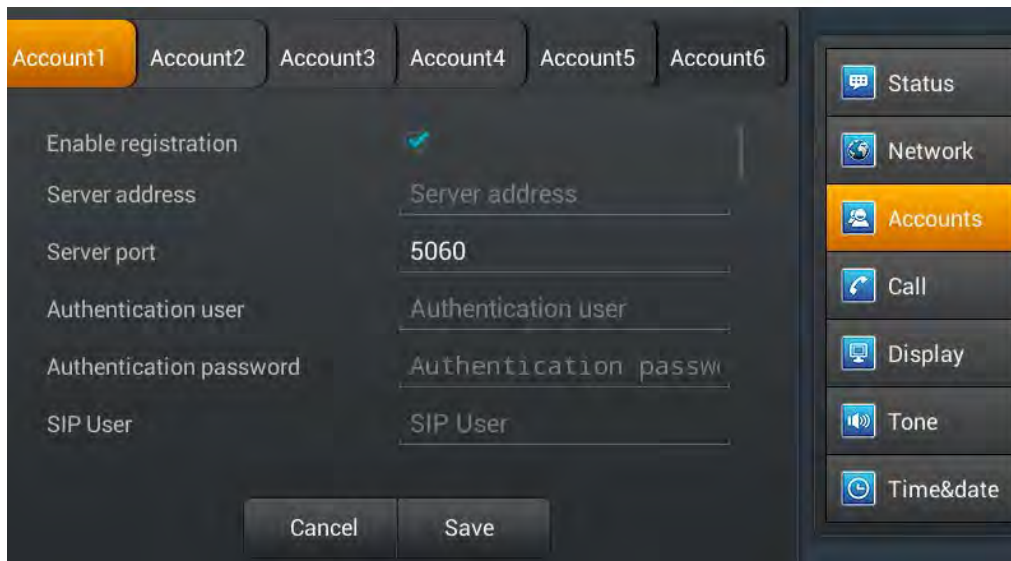

Account page 1

Configuration item	Meaning
Account	<p>Enable registration: Enable/Disable registration. <input type="checkbox"/> Disable register, <input checked="" type="checkbox"/> Enable register.</p> <p>Server address: Set your SIP server address. It supports the address in the form of domain name.</p> <p>Authentication user: Set your SIP account.</p> <p>Authentication Password: Set your SIP password.</p> <p>SIP user: Input the phone number assigned by your VoIP service provider. Phone will not register if there is no phone number configured.</p>

Fanvil Technology Co., Ltd

HQ Add: Level 3, Block A, Gaoxinqi Building, Anhua Industrial Park, Qianjin 1 Road, 35th District, Bao'An, Shenzhen, 518101 P.R. China
 Tel: +86-755-2640-2199 Fax: +86-755-2640-2618 Email: fanvil@fanvil.com www.fanvil.com Beijing Tel: +86-10-5753-6809
 Suzhou Tel: +86-512-6592-0605 SEA Tel: +60-3-203-50737

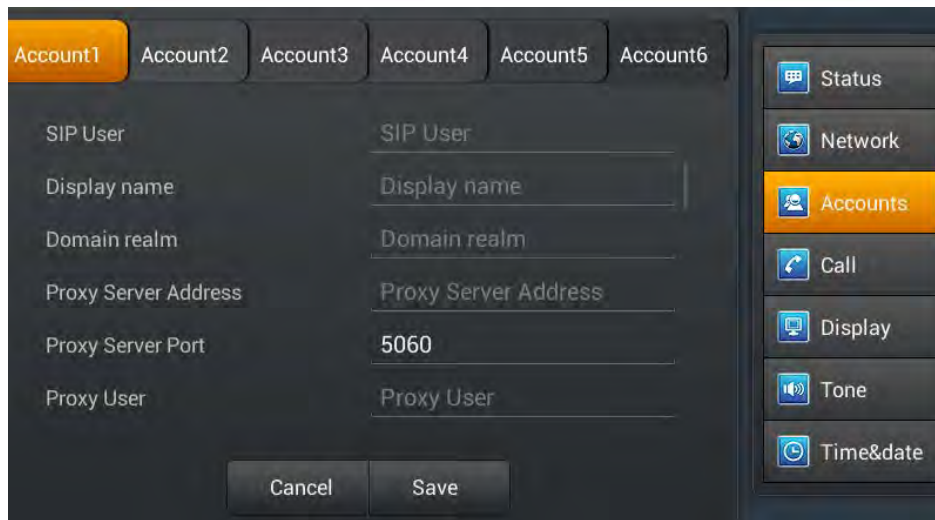

Account

Display name: Configure the display name, it allows the English alphabet input (does not support Chinese).

Domain realm: Configure the SIP domain name (You do not need to configure it because the system will configure automatically).

Proxy Server Address:Configure the proxy server address.

Proxy Server Port:Configure the proxy server address.

Backup Proxy Server Address:Configure a backup server address. When the primary server is not connected, you can use the backup server for calling communications (The backup server can be connected only when the primary server cannot connect); When the primary server is

Fanvil Technology Co., Ltd

HQ Add: Level 3, Block A, Gaoxinqi Building, Anhua Industrial Park, Qianjin 1 Road, 35th District, Bao'An, Shenzhen, 518101 P.R. China
Tel: +86-755-2640-2199 Fax: +86-755-2640-2618 Email: fanvil@fanvil.com www.fanvil.com Beijing Tel: +86-10-5753-6809
Suzhou Tel: +86-512-6592-0605 SEA Tel: +60-3-203-50737

connected, the phone will automatically switch back to the primary server to communicate.

Backup server port: Configure the backup server port.

Backup Proxy Server port: Configure the SIP register proxy server port.

Server name: Configure the SIP register server name.

Registration expire(s): Configure the server registration expire(s), default is 60 seconds. If the registration time of the server required is greater or less than the time of the phone to configure, telephone can automatically modify to the time limit that server recommended, and register again.

DTMF Type: Set DTMF mode, there are four types:

In-band

RFC2833

SIP_INFO

AUTO

Different server vendors can provide different models.

RFC protocol edition: Configure the protocol version of the phone. When your phone needs to

Fanvil Technology Co., Ltd

HQ Add: Level 3, Block A, Gaoxinqi Building, Anhua Industrial Park, Qianjin 1 Road, 35th District, Bao'An, Shenzhen, 518101 P.R. China
Tel: +86-755-2640-2199 Fax: +86-755-2640-2618 Email: fanvil@fanvil.com www.fanvil.com Beijing Tel: +86-10-5753-6809
Suzhou Tel: +86-512-6592-0605 SEA Tel: +60-3-203-50737

communicate with gateway which uses SIP1.0, such as CISCO5300, you need to configure to RFC2543 to conduct normal communication. RFC3261 is used by default.

Anonymous call edition: Configure whether to use anonymous security call. It supports RFC3323 and RFC3325.

Transport protocol: Configure the transport protocol, TCP, UDP or TLS.

Ban anonymous call: Configure whether to ban anonymous call.

Enable strict proxy: Compatible with special server. (Using source address of opposite side when return message, no longer use the address in via field).

Subscribe for MWI: After successful registration, you can subscribe to information, such as someone else's status or voice mail and so on.

Enable rport: Configure whether to support RFC3581, rport mechanism is used in internal network, and requires a SIP server to support, it is used for keeping the NAT connect of the internal network and the external network.

Enable PRACK: Configure whether to support

Fanvil Technology Co., Ltd

HQ Add: Level 3, Block A, Gaoxinqi Building, Anhua Industrial Park, Qianjin 1 Road, 35th District, Bao'An, Shenzhen, 518101 P.R. China
Tel: +86-755-2640-2199 Fax: +86-755-2640-2618 Email: fanvil@fanvil.com www.fanvil.com Beijing Tel: +86-10-5753-6809
Suzhou Tel: +86-512-6592-0605 SEA Tel: +60-3-203-50737

SIP-PRACK function (used by "Color Ring Back Tone") Recommend: Use the default configuration.

Convert URI: When you send URI it will convert # to %23.

Enable DNS SRV: Configure whether to enable RFC2782 protocol edition.

Enable displayname quote: Set to make quotation mark to display name as the phone sends out signal, in order to be compatible with server.

Use Stun: Enable/Disable SIP STUN.

Enable BLF List: Enable/Disable BLF List.

BLF list number: Input the number of BLF List.

Enable session timer: Enable/Disable session timeout.

Session timeout(s): Set the time of session timeout.

Call

Tap "Call" enter the interface, after configuring the parameters of each interface, you can click "Save" button to save.

Fanvil Technology Co., Ltd

HQ Add: Level 3, Block A, Gaoxinqi Building, Anhua Industrial Park, Qianjin 1 Road, 35th District, Bao'An, Shenzhen, 518101 P.R. China
Tel: +86-755-2640-2199 Fax: +86-755-2640-2618 Email: fanvil@fanvil.com www.fanvil.com Beijing Tel: +86-10-5753-6809
Suzhou Tel: +86-512-6592-0605 SEA Tel: +60-3-203-50737

General

Tap “Call” ——>”General” interface, after configuring the parameters, you can click "Save" button to save.

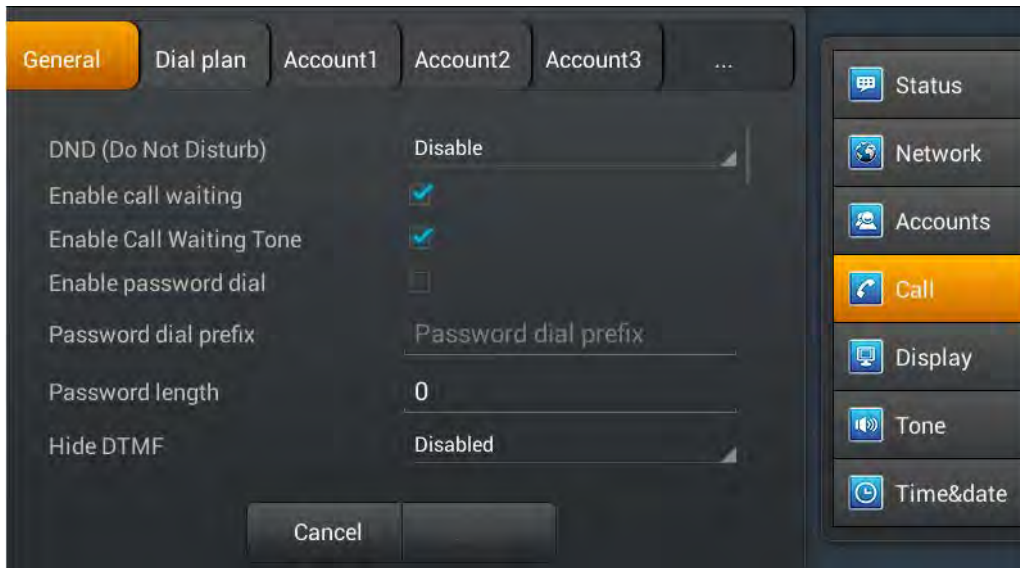

General interface

Configuration	Meaning
General	<p>Do not disturb: It will not allow any phone call while enable the function, but there will have prompt in the missed calls.</p> <p>Enable call waiting: Whether enable call waiting.</p> <p>Call waiting tone: If enable the function, there will have call waiting tone if there has a call waiting.</p> <p>Enable password dial: Whether enable the password dial.</p> <p>Password dial prefix: Set the prefix of the number.</p> <p>Password length: After setting the length successfully,</p>

Fanvil Technology Co., Ltd

HQ Add: Level 3, Block A, Gaoxing Building, Anhua Industrial Park, Qianjin 1 Road, 35th District, Bao'An, Shenzhen, 518101 P.R. China
 Tel: +86-755-2640-2199 Fax: +86-755-2640-2618 Email: fanvil@fanvil.com www.fanvil.com Beijing Tel: +86-10-5753-6809
 Suzhou Tel: +86-512-6592-0605 SEA Tel: +60-3-203-50737

the number dialed out will hide the appropriate length .For example, sets the prefix number to 138,the password length is 5, and dial the number 138142658941 ,then it will display as 138*****8941 on the dial interface.

Hide DTMF: It has four choices: Disable, All, Delay and Last show.

Disable that is the content you input is clear text and it can be seen.

All that is the content you input is hidden immediately and displayed as “*”

Delay that is the content you input will display in clear text first and then displayed as “*”

Last show that is the last one inputted will displayed in clear text and the others will displayed as “*”.

Ban outgoing: Forbid call out.

Enable call transfer: Enable /disenable the function, if disable the function,the phone can not do transfer .

Semi-attended transfer: During the talk, press Transfer firstly, and then press Send after inputting the number that you want to transfer to. You are waiting for connection, now, press Transfer and the transfer will be done. (To use this feature, you need enable call waiting and call transfer first).

Enable Auto on Hook: Enable this function, and set the auto on hook time, the phone will auto return to previous interface afer the time when end a call.

Enable 3-way Conference:You can make a conference when enale this function.

Enable call completion: Enable Call Completion by selecting it, If the callee is busy, the sip server will inspect the callee status at intervals. If the callee is idle, the server will send notify message to inform the caller whether redial.

Fanvil Technology Co., Ltd

HQ Add: Level 3, Block A, Gaoxinqi Building, Anhua Industrial Park, Qianjin 1 Road, 35th District, Bao'An, Shenzhen, 518101 P.R. China
Tel: +86-755-2640-2199 Fax: +86-755-2640-2618 Email: fanvil@fanvil.com www.fanvil.com Beijing Tel: +86-10-5753-6809
Suzhou Tel: +86-512-6592-0605 SEA Tel: +60-3-203-50737

Enable auto redial: Enable this function, calling out someone, if he is in busy, it will pop up a prompt box whether to auto redial, press OK, the phone will call out him according the Interval and Times that you set.

Auto redial interval: Specify the Auto Redial interval.

Auto redial times: Specify the Auto Redial times.

Enable intercom: Enable Intercom Mode by selecting it. Then you can set up connection to the operator or the secretary quickly, and it widely used in office environments.

Enable intercom mute: Enable mute mode during the intercom call.

Enable intercom tone: If the incoming call is intercom call, the phone plays the intercom tone.

Enable intercom barge: Enable Intercom Barge by selecting it, the phone auto answers the intercom call during a call. If the current call is intercom call, the phone will reject the second intercom call.

Update dial call: Enable this function, the phone will update the peer display name based on the 200OK packet.

Ring from headset: Enable Ring From Handset by selecting it, the phone plays ring tone from handset.

Enable Hide Local Area Code: Enable /disable the function, if enable the function it will hide the local number.

Auto Hold:when you call or receive the second way calls, the phone will hold the first way call.

Country code:Input the country number, such as the number of China is 86.

Area code: input the region number, that is the area number ,for example ,the number of Beijing is 10.

Call Waiting Code: You can choose the Call waiting response, 180 or 182.

Default Ext Line:You can select any sip to be the default line, the number will display in the upper-left.

Default Dial Mode:Choose the default mode when you call other.

Default Ans Mode:Choose the mode how you receive the call.

Accept video mode: You can choose “Manual accept video”, “Auto accept video” or “Auto reject video”.

Enable Record:You can record the conversation when enable this function.

Use SIP numbering plan:Enable this function, you can register the sip number with letters and characters.

Configure Emergency Number: You can configure one or more number here, and call them even if the screen lock.

Enable 3rd IM App:Enable this function, you can install the third instant messaging app.

IM App:If you select the third app, when you pick up handset or press Headset/Handsfree key, the phone will use the app to make a call.

Dial plan

Tap "Call"----> "Dial plan" interface. After configuring the parameters, you can click "Save" button to save.

Fanvil Technology Co., Ltd

HQ Add: Level 3, Block A, Gaoxinqi Building, Anhua Industrial Park, Qianjin 1 Road, 35th District, Bao'An, Shenzhen, 518101 P.R. China
Tel: +86-755-2640-2199 Fax: +86-755-2640-2618 Email: fanvil@fanvil.com www.fanvil.com Beijing Tel: +86-10-5753-6809
Suzhou Tel: +86-512-6592-0605 SEA Tel: +60-3-203-50737

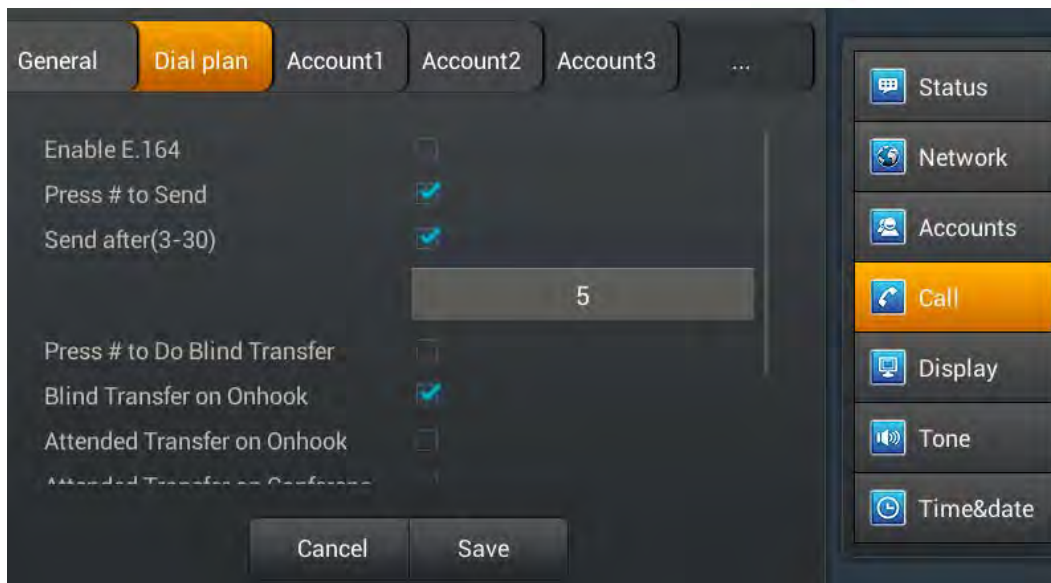

Dial plan interface

Configuration item	Meaning
Dial plan	<p>Use E164: Enable/Disable E164. After it is enabled, it will directly dial numbers according with E164 rules.</p> <p>Press # to Send: Enable/Disable. After enabling the function, input the number end with "#" in the non-pre-dial mode, it will directly dial the phone number.</p> <p>Press # to Do Blind Transfer:Enable/Disable. After enable this function, when you do a blind transfer, you can input number end with “#” do send it.</p>

Fanvil Technology Co., Ltd

HQ Add: Level 3, Block A, Gaoxinqi Building, Anhua Industrial Park, Qianjin 1 Road, 35th District, Bao'An, Shenzhen, 518101 P.R. China
 Tel: +86-755-2640-2199 Fax: +86-755-2640-2618 Email: fanvil@fanvil.com www.fanvil.com Beijing Tel: +86-10-5753-6809
 Suzhou Tel: +86-512-6592-0605 SEA Tel: +60-3-203-50737

Blind Transfer on Onhook:Enable/Disable. After enable this function, when you end input the transfer number, you can directly on hook the phone to do the blind transfer.

Attended Transfer on Onhook:Same as above, but do the attended transfer.

Attended Transfer on Conference:Enable this function, when you host a 3-way conference, you can on hook to do the attended transfer.

Dial prefix: Enable/Disable. After enabled the function, it will be automatically added the outside line prefix number before the outgoing number when you are going to call.

Method to use the prefix: Example

If you set the prefix is 135856, and you want to dial the number 13585679801. Then when you dial the number, you can press and hold 0, when the “+” appears, you can just input 79801 and send the number, the “+79801” is the number you input, but you can see the dialing number is 13585679801.

Account

Tap “Call” ——>”Account1\2\3\4\5\6” interface, after configuring the parameters, you can click "Save" button to save.

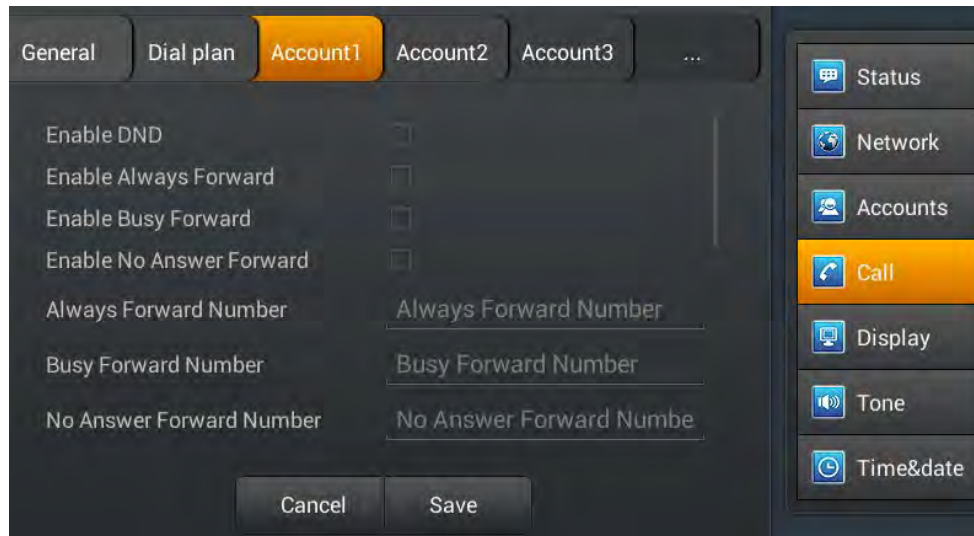

Account 1

Configuration

Meaning

Account 1

Enable DND:When enable the DND line, you can choose to enable DND here to control this account reject the incoming call.

Enable Always Forward:Set the forward number below and enable this function, when it has a coming call, the phone will forward the call to the setting number and display one missed call.

Enable Busy Forward:Same as the above function, but when the phone has one call it can forward the incoming call.

Fanvil Technology Co., Ltd

HQ Add: Level 3, Block A, Gaoxing Building, Anhua Industrial Park, Qianjin 1 Road, 35th District, Bao'An, Shenzhen, 518101 P.R. China
 Tel: +86-755-2640-2199 Fax: +86-755-2640-2618 Email: fanvil@fanvil.com www.fanvil.com Beijing Tel: +86-10-5753-6809
 Suzhou Tel: +86-512-6592-0605 SEA Tel: +60-3-203-50737

No Answer Forward Number: Same as the above, when the phone does not answer the call after timeout, it will forward the incoming call.

MWI number: Fill in the MWI number.

Enable Hotline: Enable this function, configure the hotline number and time, the phone will auto call this number when enter the dialing interface and timeout.

Enable auto answer: Enable auto answer and set the timeout, when the phone has incoming call, it will auto answer when time out.

Enable missed call log: Enable this function, the status bar has prompt when missed incoming calls and save them to call log history .

Caller ID Type: It is default display long number, and support standard ISP number .If not enable, the phone will display last few numbers matched.

Enable user=phone: Enable this, the phone can make call directly, if not, you need to precede the phone number with country code and Area code, Depending on your environment.

Dial without registered: Set call out by proxy without registration.

Display

Configuring the phone screen displays a number of parameters, including screensavers and power indicator

After enable operator mode, if you press the home key, the main interface will enter dsskey interface. If disable this function, the phone will return to desktop interface when press home key.

When enable shortcuts, you can press and hold the application to set shortcuts to desktop.

Tap "Display" ----> "Display" interface. After configuring the parameters, you can click "Save" button to save successfully.

Tone

Configuration of the telephone voice parameters, including selecting a ringtone, SMS notification tones, keypad tones, and other

Tap "Settings" ----> "Sound" interface. After configuring the parameters, you can click "Save" button to save successfully.

Fanvil Technology Co., Ltd

HQ Add: Level 3, Block A, Gaoxinqi Building, Anhua Industrial Park, Qianjin 1 Road, 35th District, Bao'An, Shenzhen, 518101 P.R. China
Tel: +86-755-2640-2199 Fax: +86-755-2640-2618 Email: fanvil@fanvil.com www.fanvil.com Beijing Tel: +86-10-5753-6809
Suzhou Tel: +86-512-6592-0605 SEA Tel: +60-3-203-50737

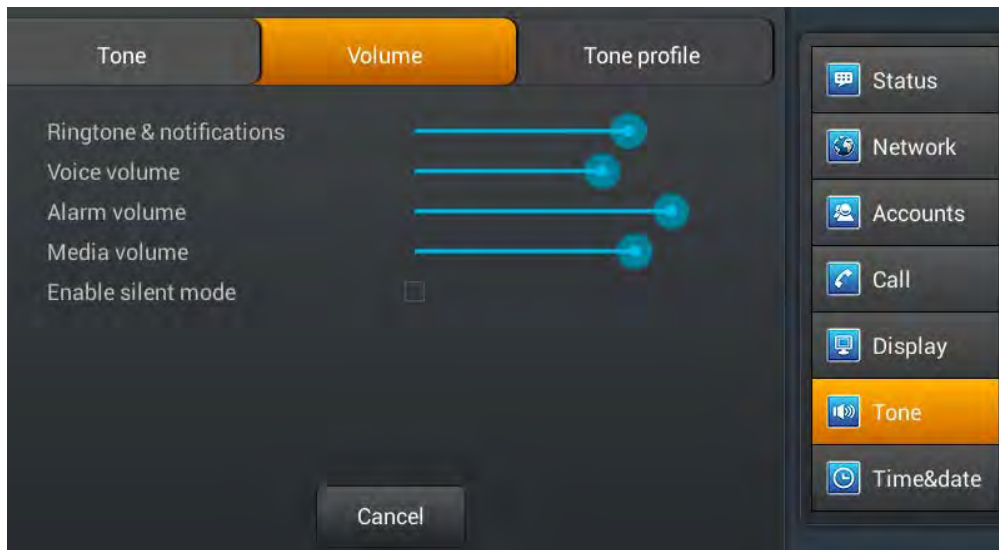

Time&date

Tap "Settings" ----> "Date time" interface. After configuring the parameters, you can click "Save" button to save successfully.



Fanvil Technology Co., Ltd

HQ Add: Level 3, Block A, Gaoxinqi Building, Anhua Industrial Park, Qianjin 1 Road, 35th District, Bao'An, Shenzhen, 518101 P.R. China
Tel: +86-755-2640-2199 Fax: +86-755-2640-2618 Email: fanvil@fanvil.com www.fanvil.com Beijing Tel: +86-10-5753-6809
Suzhou Tel: +86-512-6592-0605 SEA Tel: +60-3-203-50737

Maintain

Tap "Settings" ----> "Maintain" Enter the interface.

Service port

Tap "Maintain"---->"Service port" interface. After configured the parameters, you can click "Save" button to save successfully.



Service port interface

Configuration	Meaning
Service port	<p>Enable telnet: Open telnet function.</p> <p><i>Telnet</i> is a common method of remote control of the Web server, end users can enter the command telnet program, these commands will be run on the server, just like directly on the server console, enter the same. Can locally be able to control the server.</p>

Fanvil Technology Co., Ltd

HQ Add: Level 3, Block A, Gaoxingqi Building, Anhua Industrial Park, Qianjin 1 Road, 35th District, Bao'An, Shenzhen, 518101 P.R. China
 Tel: +86-755-2640-2199 Fax: +86-755-2640-2618 Email: fanvil@fanvil.com www.fanvil.com Beijing Tel: +86-10-5753-6809
 Suzhou Tel: +86-512-6592-0605 SEA Tel: +60-3-203-50737

Web server type: Select "HTTP" or "HTTPS".

After selecting one server, you can use the selected server to login the telephone's web page.

Such as: https://192.168.1.20

HTTP port: Input server port, default is 80.

CWMP set

Tap "Maintain"---->" CWMP set" interface. After configured the parameters, you can click "Save" button to save successfully.

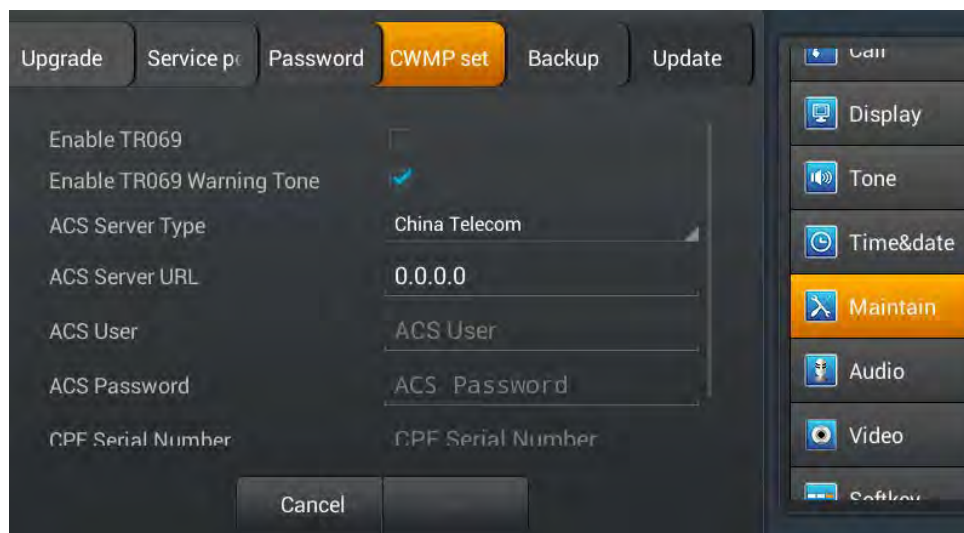

CWMP set Interface 1

Fanvil Technology Co., Ltd

HQ Add: Level 3, Block A, Gaoxinqi Building, Anhua Industrial Park, Qianjin 1 Road, 35th District, Bao'An, Shenzhen, 518101 P.R. China
Tel: +86-755-2640-2199 Fax: +86-755-2640-2618 Email: fanvil@fanvil.com www.fanvil.com Beijing Tel: +86-10-5753-6809
Suzhou Tel: +86-512-6592-0605 SEA Tel: +60-3-203-50737



CWMP set Interface 2

Configuration	Meaning
---------------	---------

	Enter the password to access the network menu landing configuration interface.
--	--

Enable TR069: Enable network mode , select China Telecom or Normal.

CWMP set

ACS Server:Input the address of the ACS server provider.

Account:Input service provider assigns the account.

Password:Input the account corresponding password.

Serial Number:Input the Serial number.

Auto connect:When enabled, you can fill out the account and password.

Backup

Tap "Maintain"---->" Backup" , the default password is 123456, enter the backup interface.

Fanvil Technology Co., Ltd

HQ Add: Level 3, Block A, Gaoxinqi Building, Anhua Industrial Park, Qianjin 1 Road, 35th District, Bao'An, Shenzhen, 518101 P.R. China
 Tel: +86-755-2640-2199 Fax: +86-755-2640-2618 Email: fanvil@fanvil.com www.fanvil.com Beijing Tel: +86-10-5753-6809
 Suzhou Tel: +86-512-6592-0605 SEA Tel: +60-3-203-50737

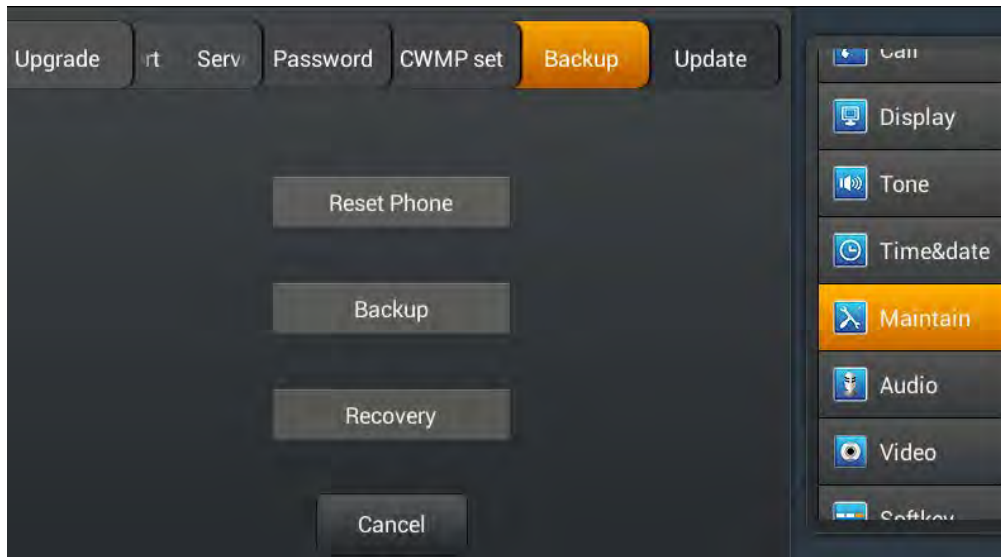

Backup Interface

Configuration	Meaning
	ResetPhone: This will erase all data from your phone's internal storage.
Backup	Backup: The contact data, phone settings data and calender backup to a specified folder.
	Recovery: Recovery has backup contacts, phone settings configuration.

Update

Tap "Maintain"---->" Update", enter the update interface.

Fanvil Technology Co., Ltd

HQ Add: Level 3, Block A, Gaoxingqi Building, Anhua Industrial Park, Qianjin 1 Road, 35th District, Bao'An, Shenzhen, 518101 P.R. China
 Tel: +86-755-2640-2199 Fax: +86-755-2640-2618 Email: fanvil@fanvil.com www.fanvil.com Beijing Tel: +86-10-5753-6809
 Suzhou Tel: +86-512-6592-0605 SEA Tel: +60-3-203-50737

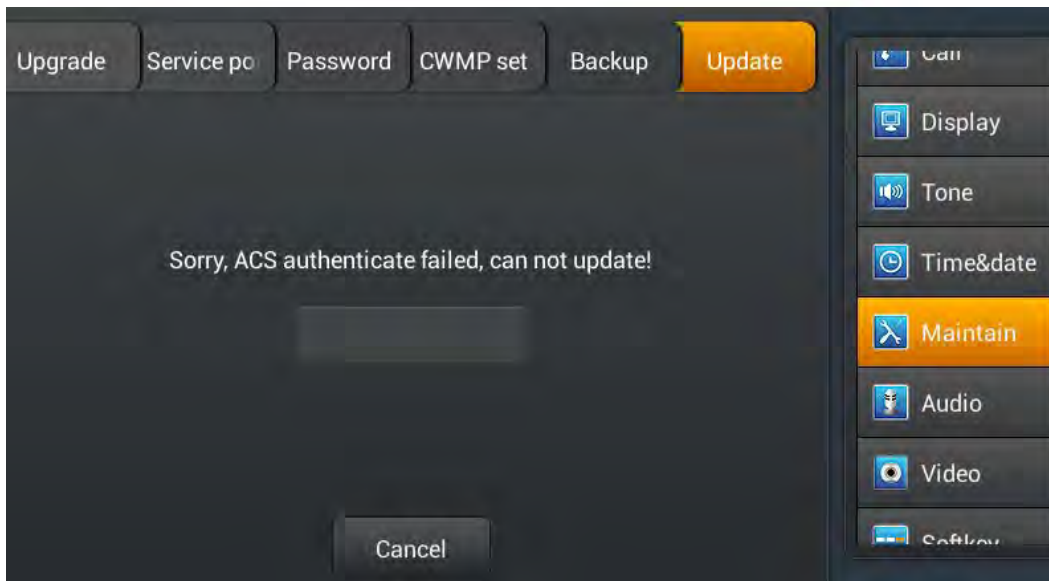

Update Interface

Configuration	Meaning
System update	For ACS certification, authentication is successful you can check the system updates

Audio

Touch "Settings" ----> "Audio", enter the detailed view.

Audio

Touch "Audio"----> "Audio" interface. This is global setting, applies to all the sip lines. After configuring the parameters, you can click "Save" button to save successfully.

Fanvil Technology Co., Ltd

HQ Add: Level 3, Block A, Gaoxing Building, Anhua Industrial Park, Qianjin 1 Road, 35th District, Bao'An, Shenzhen, 518101 P.R. China
 Tel: +86-755-2640-2199 Fax: +86-755-2640-2618 Email: fanvil@fanvil.com www.fanvil.com Beijing Tel: +86-10-5753-6809
 Suzhou Tel: +86-512-6592-0605 SEA Tel: +60-3-203-50737

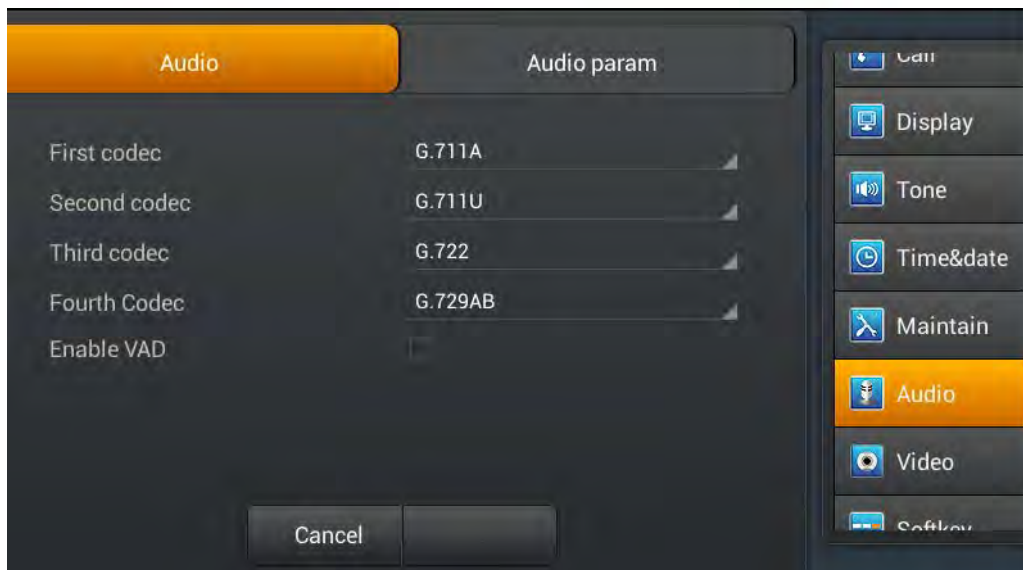

Audio interface

Configuration item	Meaning
Audio	Enable VAD: Whether to enable VAD. (Voice Activity Detection); If you enabling VAD function, then the G.729 payload length cannot be set greater than 20ms.

Audio param

Touch "Audio"----> "Audio param" interface. After configuring the parameters, you can click "Save" button to save successfully.

Fanvil Technology Co., Ltd

HQ Add: Level 3, Block A, Gaoxingqi Building, Anhua Industrial Park, Qianjin 1 Road, 35th District, Bao'An, Shenzhen, 518101 P.R. China
 Tel: +86-755-2640-2199 Fax: +86-755-2640-2618 Email: fanvil@fanvil.com www.fanvil.com Beijing Tel: +86-10-5753-6809
 Suzhou Tel: +86-512-6592-0605 SEA Tel: +60-3-203-50737



Audio param interface

Video

Touch "Settings" ----> "Video" and enter the settings interface.

Video param

Touch "Video"----> "Video param" interface. After configuring the parameters, you can click "Save" button to save successfully.

Note:If you want More clear and smooth video screen, please select H.264 within 2M bandwidth.

Fanvil Technology Co., Ltd

HQ Add: Level 3, Block A, Gaoxinqi Building, Anhua Industrial Park, Qianjin 1 Road, 35th District, Bao'An, Shenzhen, 518101 P.R. China
Tel: +86-755-2640-2199 Fax: +86-755-2640-2618 Email: fanvil@fanvil.com www.fanvil.com Beijing Tel: +86-10-5753-6809
Suzhou Tel: +86-512-6592-0605 SEA Tel: +60-3-203-50737



Video param interface

Bandwidth

Touch "Video"----> "Bandwidth" interface. After configuring the parameters, you can click "Save" button to save successfully.

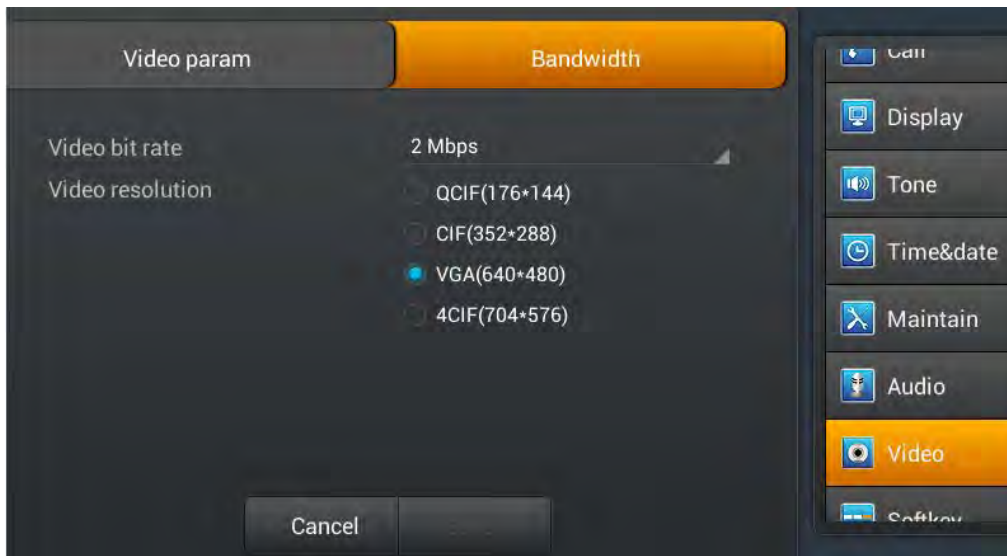

Bandwidth interface

Fanvil Technology Co., Ltd

HQ Add: Level 3, Block A, Gaoxinqi Building, Anhua Industrial Park, Qianjin 1 Road, 35th District, Bao'An, Shenzhen, 518101 P.R. China
Tel: +86-755-2640-2199 Fax: +86-755-2640-2618 Email: fanvil@fanvil.com www.fanvil.com Beijing Tel: +86-10-5753-6809
Suzhou Tel: +86-512-6592-0605 SEA Tel: +60-3-203-50737

Configuration item	Meaning
Bandwidth	<p>Video bit rate: Set receiving video bandwidth in video calls. You can choose 11 kinds of video bandwidth types ("64Kbps", "192Kbps", "256Kbps", "384Kbps", "512Kbps", "768Kbps", "1Mbps", "1.6Mbps", "2Mbps", "3Mbps" or "4Mbps").</p> <p>Video Resolution: Set video encoding resolution in a video call. You can choose 4 types of video resolution ("QCIF (176*144)", " CIF (352*288)", "VGA(640*480)" or " 4CIF (704*576)").</p>

Softkey

Tap “Settings->Softkey” enter softkey interface. Select softkey-screen first, then add or delete the softkey by clicking the arrow, you can also click the arrow up or down to adjust the softkey’s position.

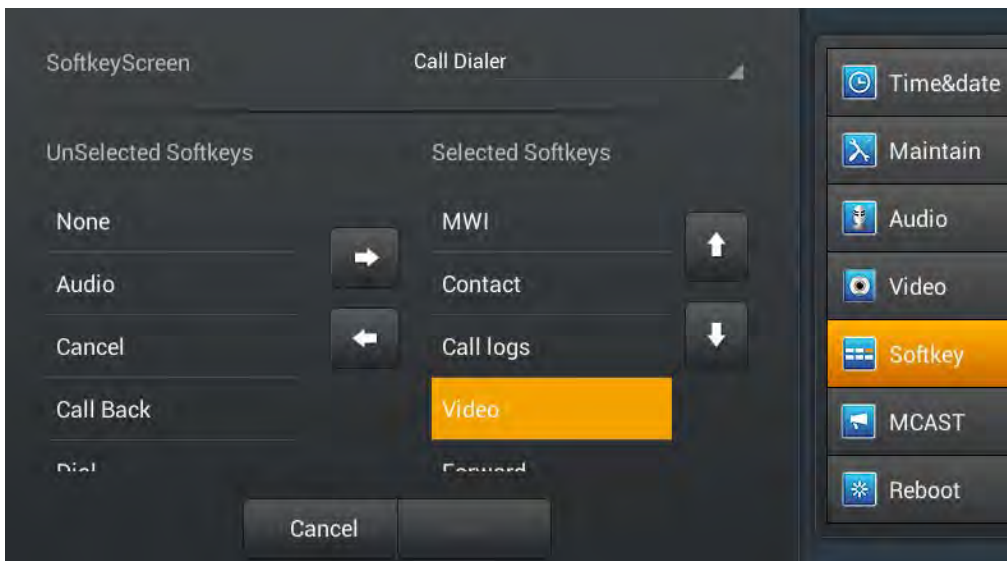

Softkey interface

Fanvil Technology Co., Ltd

HQ Add: Level 3, Block A, Gaoxingqi Building, Anhua Industrial Park, Qianjin 1 Road, 35th District, Bao'An, Shenzhen, 518101 P.R. China
 Tel: +86-755-2640-2199 Fax: +86-755-2640-2618 Email: fanvil@fanvil.com www.fanvil.com Beijing Tel: +86-10-5753-6809
 Suzhou Tel: +86-512-6592-0605 SEA Tel: +60-3-203-50737

For example, the below picture shows the call dialer softkey. It can show up to six keys.



Call Dialer softkey

MCAST

This feature allows you to make some kind of broadcast call to people who are in multicast group. You can configure a multicast DssKey on the phone, which allows you to send a Real Time Transport Protocol (RTP) stream to the pre-configured multicast address(es) without involving SIP signaling. You can also configure the phone to receive an RTP stream from pre-configured multicast listening address(es) without involving SIP signaling. You can specify up to 10 multicast listening addresses.

Tap “Settings->MCAST” enter the multi-cast interface, you can follow the prompts to fill in the name and host, you can also set the priority for the call.

MCAST Setting	Meaning
Normal Call Priority	Define the priority of the active call, 1 is the highest priority, 10 is the lowest.
Enable Page Priority	The voice call in progress shall take precedence over all incoming paging calls.
Name	Listened multicast server name

Fanvil Technology Co., Ltd

HQ Add: Level 3, Block A, Gaoxinqi Building, Anhua Industrial Park, Qianjin 1 Road, 35th District, Bao'An, Shenzhen, 518101 P.R. China
 Tel: +86-755-2640-2199 Fax: +86-755-2640-2618 Email: fanvil@fanvil.com www.fanvil.com Beijing Tel: +86-10-5753-6809
 Suzhou Tel: +86-512-6592-0605 SEA Tel: +60-3-203-50737

Host:port	Listened multicast server' s multicast IP address and port.
------------------	---

Reboot

Tap "Maintain"----> "Reboot" interface. You can click "Reboot" button to pop-up "reboot" dialog box, click "OK" to reboot the phone, click "Cancel" will have no operation.

Call Service

Register

You can register the sip line on the web or by LCD, the below picture show the web register configuration. The status can show the if the line register successfully. When register success, the upper-left of status bar will show the display name and number

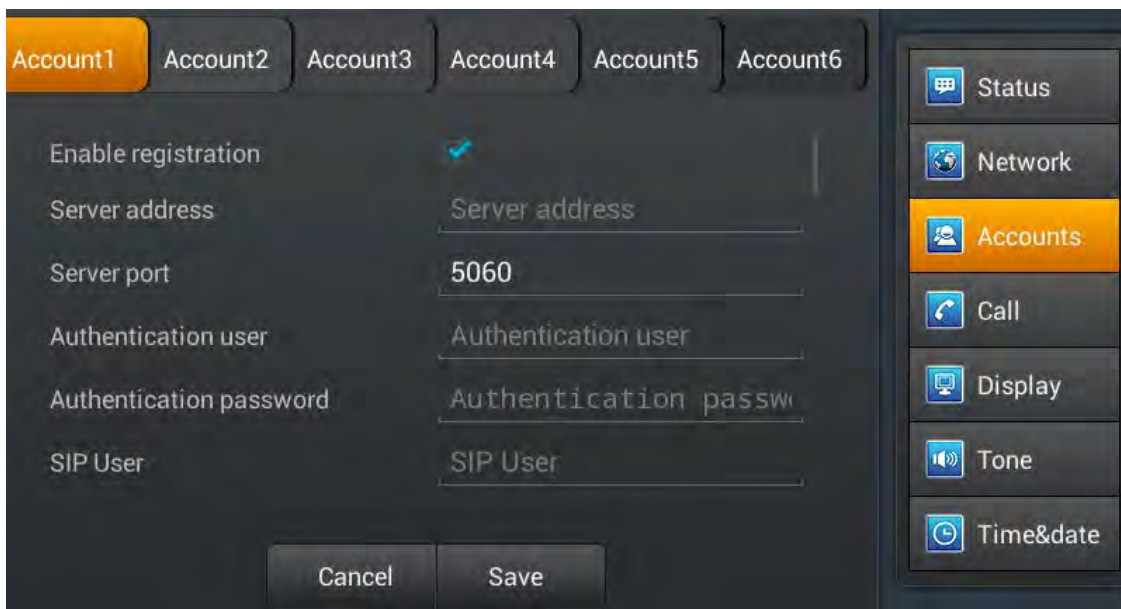

Register

Fanvil Technology Co., Ltd

HQ Add: Level 3, Block A, Gaoxingqi Building, Anhua Industrial Park, Qianjin 1 Road, 35th District, Bao'An, Shenzhen, 518101 P.R. China
 Tel: +86-755-2640-2199 Fax: +86-755-2640-2618 Email: fanvil@fanvil.com www.fanvil.com Beijing Tel: +86-10-5753-6809
 Suzhou Tel: +86-512-6592-0605 SEA Tel: +60-3-203-50737

Outgoing & Incoming call

1. Pick up the handset, press the headset/handsfree key or click line key to the dial interface;
2. Select the line and enter the number ;
3. Click #send, it will call out follow the default dial mode you set;
4. You can also click video to invite a video call.



When the phone has an incoming call, you can click audio or video to answer the call, if you did not select, the phone will follow the default ans mode you set when you pick up the handset. You can also choose forward or reject the call.

Video Call

1. Pick up the handset, press the headset/handsfree key or click line key to the dial interface;
2. Select the line and enter the number;
3. Click “Video” to make a call;

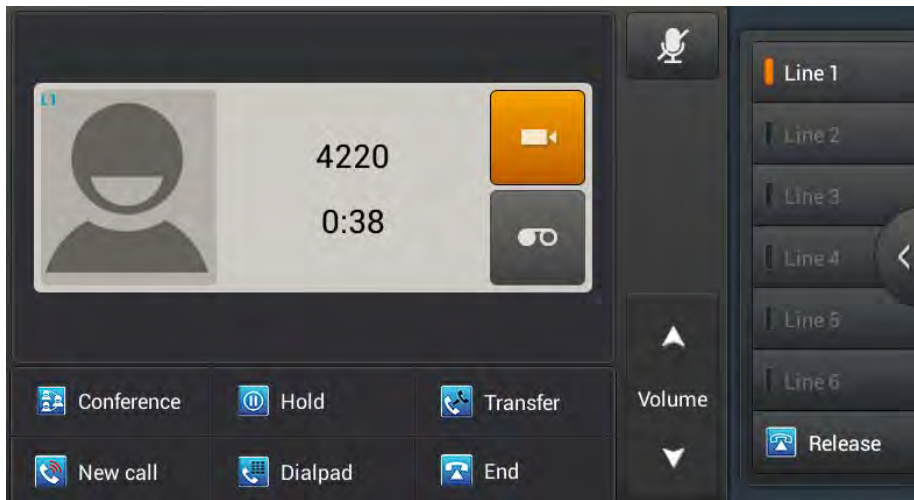

Fanvil Technology Co., Ltd

HQ Add: Level 3, Block A, Gaoxinqi Building, Anhua Industrial Park, Qianjin 1 Road, 35th District, Bao'An, Shenzhen, 518101 P.R. China
Tel: +86-755-2640-2199 Fax: +86-755-2640-2618 Email: fanvil@fanvil.com www.fanvil.com Beijing Tel: +86-10-5753-6809
Suzhou Tel: +86-512-6592-0605 SEA Tel: +60-3-203-50737



4. Click  to end or re-invite the video;



5. Click  and  to adjust the video screen mode and video mode.

Blind Transfer

1. During the call, click transfer enter the dial interface;
2. Input the number or select contact from contacts or call log;
3. Click transfer;
4. If transfer success, the phone will auto end the call, if transfer failed, the phone will return to the conversation interface and hold the call.

Fanvil Technology Co., Ltd

HQ Add: Level 3, Block A, Gaoxinqi Building, Anhua Industrial Park, Qianjin 1 Road, 35th District, Bao'An, Shenzhen, 518101 P.R. China
 Tel: +86-755-2640-2199 Fax: +86-755-2640-2618 Email: fanvil@fanvil.com www.fanvil.com Beijing Tel: +86-10-5753-6809
 Suzhou Tel: +86-512-6592-0605 SEA Tel: +60-3-203-50737



Semi-attended Transfer

1. During the conversation, click transfer enter the dial interface;
2. Input the number or select contact from contacts or call log, final, click #send;
3. When the other end ringing, click transfer to complete the semi attend transfer.

NOTE: If you want to use this function, you need to enable the call waiting and call transfer.

Fanvil Technology Co., Ltd

HQ Add: Level 3, Block A, Gaoxinqi Building, Anhua Industrial Park, Qianjin 1 Road, 35th District, Bao'An, Shenzhen, 518101 P.R. China
 Tel: +86-755-2640-2199 Fax: +86-755-2640-2618 Email: fanvil@fanvil.com www.fanvil.com Beijing Tel: +86-10-5753-6809
 Suzhou Tel: +86-512-6592-0605 SEA Tel: +60-3-203-50737

Attended Transfer

1. During the conversation, press the transfer key ;
2. Input the number you want to transfer to;
3. Tap “#send”;
4. Press transfer key after the call answered , and transferred successfully.

NOTE:

Call waiting and call transfer must be enabled.
The SIP server must support RFC3515.

Conference Call

1. Press the CONF softkey during an active call.
2. The first call will be placed on hold and dial tone will be heard.
3. Dial the number to be added to the conference.
4. Press Send.
5. When the call is answered, the conference will be started.
6. To release the conference, press Split.

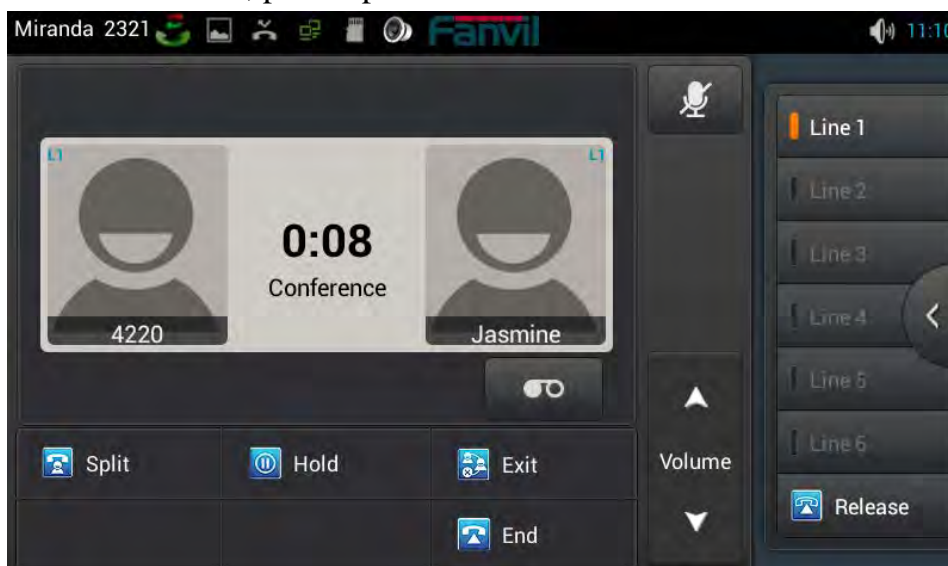

Conference Interface

Fanvil Technology Co., Ltd

HQ Add: Level 3, Block A, Gaoxinqi Building, Anhua Industrial Park, Qianjin 1 Road, 35th District, Bao'An, Shenzhen, 518101 P.R. China
Tel: +86-755-2640-2199 Fax: +86-755-2640-2618 Email: fanvil@fanvil.com www.fanvil.com Beijing Tel: +86-10-5753-6809
Suzhou Tel: +86-512-6592-0605 SEA Tel: +60-3-203-50737

Call Hold



1. Click the “Hold” to put the active call on hold.
2. If there is only one call on hold, press the “Resume” to retrieve the call.
3. If there is more than one call on hold, click the dialog to change conversation, then click the Resume button to retrieve the call.

Fanvil Technology Co., Ltd

HQ Add: Level 3, Block A, Gaoxingqi Building, Anhua Industrial Park, Qianjin 1 Road, 35th District, Bao'An, Shenzhen, 518101 P.R. China
Tel: +86-755-2640-2199 Fax: +86-755-2640-2618 Email: fanvil@fanvil.com www.fanvil.com Beijing Tel: +86-10-5753-6809
Suzhou Tel: +86-512-6592-0605 SEA Tel: +60-3-203-50737

Android Settings

Ethernet configuration

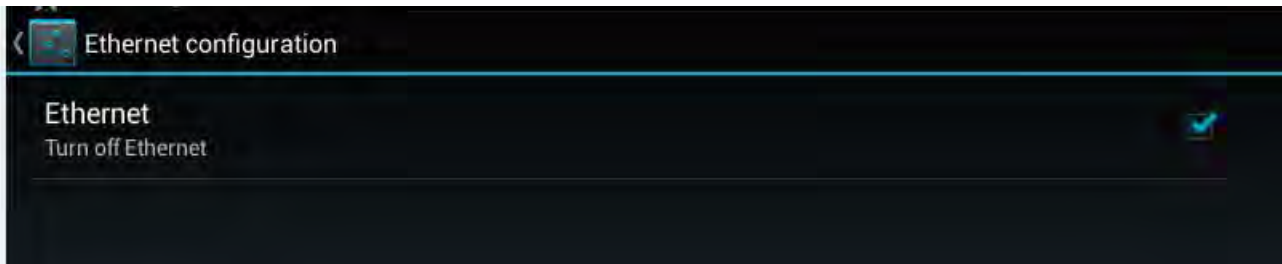

Click "Settings", select " Ethernet configuration" switch to the Ethernet configuration interface. You can choose to turn on or turn off the Ethernet, if you turn on the Ethernet, it will auto connect to networking, otherwise, the phone can not connect to networking.

Security

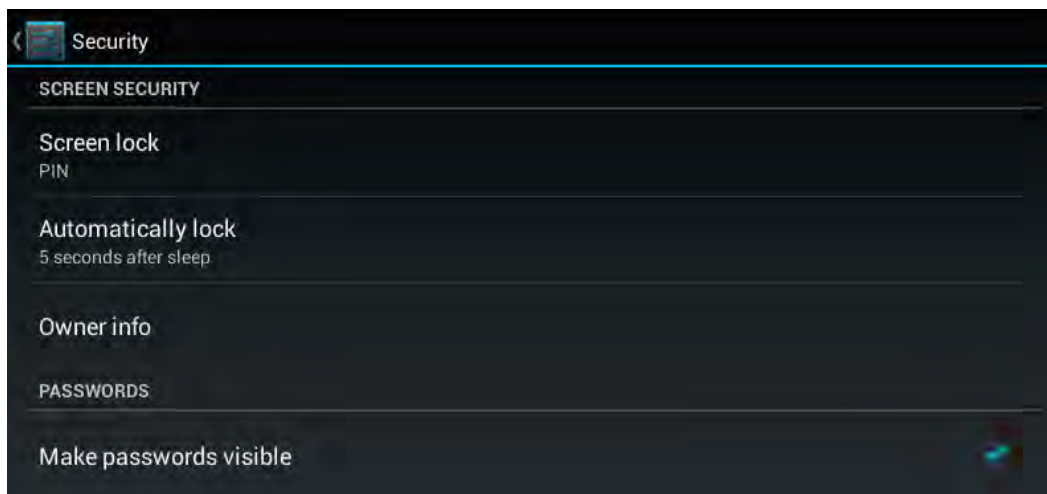

1.Set the Screen lock

- Click “Settings”, enter the android settings interface;
- Click Security->Screen lock enter the configuration interface;
- Follow the prompts to set screen lock which you want to use;
- Set automatically lock time.

Fanvil Technology Co., Ltd

HQ Add: Level 3, Block A, Gaoxingqi Building, Anhua Industrial Park, Qianjin 1 Road, 35th District, Bao'An, Shenzhen, 518101 P.R. China
Tel: +86-755-2640-2199 Fax: +86-755-2640-2618 Email: fanvil@fanvil.com www.fanvil.com Beijing Tel: +86-10-5753-6809
Suzhou Tel: +86-512-6592-0605 SEA Tel: +60-3-203-50737

2. Set owner info, it will display on the lock screen.
3. Set if make passwords visible

Language&Input

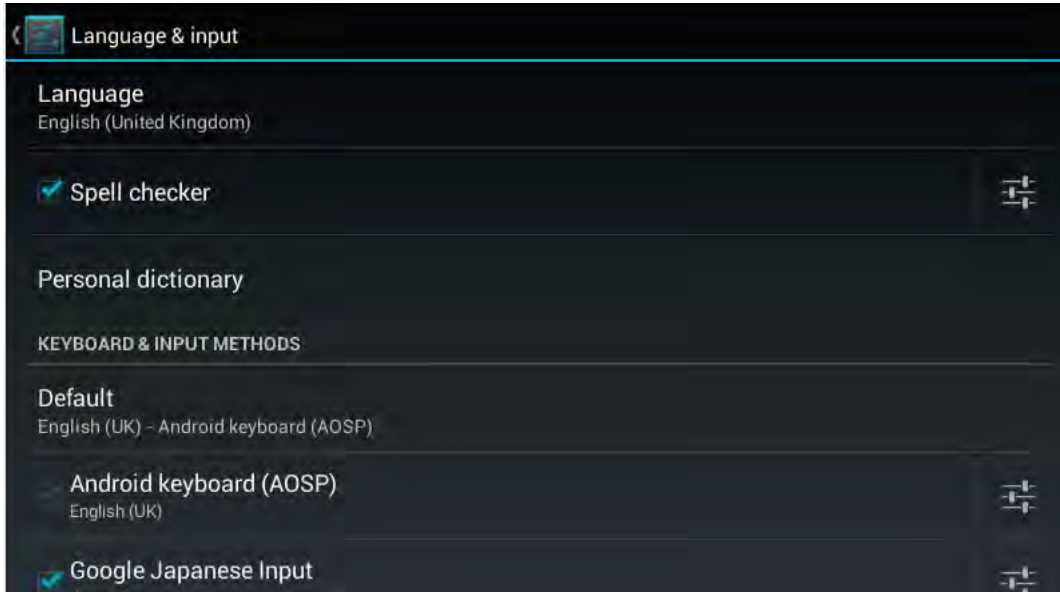

Language&input interface

1. Click “Settings” enter the android settings interface;
2. Click language&input enter the above picture interface;
3. Select language to set what you want to use;
4. Tick the input method which you want to use.

Web Settings

Logon

There are two levels of access: root level and general level. A user with root level access can browse and set all configuration parameters, while a user with general level can set all

Fanvil Technology Co., Ltd

HQ Add: Level 3, Block A, Gaoxingqi Building, Anhua Industrial Park, Qianjin 1 Road, 35th District, Bao'An, Shenzhen, 518101 P.R. China
Tel: +86-755-2640-2199 Fax: +86-755-2640-2618 Email: fanvil@fanvil.com www.fanvil.com Beijing Tel: +86-10-5753-6809
Suzhou Tel: +86-512-6592-0605 SEA Tel: +60-3-203-50737

configuration parameters except server parameters for SIP and can not browse the configuration file.

Default user with general level:

Username: guest

Password: guest

Default user with root level:

Username: admin

Password: admin

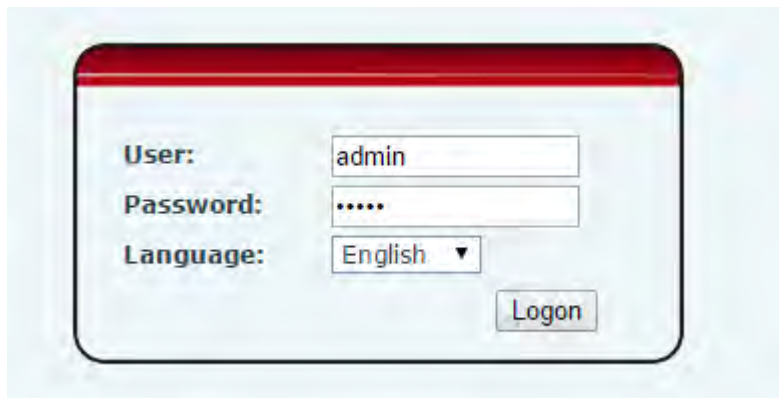

Network

About the network mode settings, please refer to the phone settings.

QoS & VLAN

The phone supports 802.1Q/P protocol and DiffServ configuration. Use of a Virtual LAN (VLAN) allows voice and data traffic to be separated.

Fanvil Technology Co., Ltd

HQ Add: Level 3, Block A, Gaoxingqi Building, Anhua Industrial Park, Qianjin 1 Road, 35th District, Bao'An, Shenzhen, 518101 P.R. China
Tel: +86-755-2640-2199 Fax: +86-755-2640-2618 Email: fanvil@fanvil.com www.fanvil.com Beijing Tel: +86-10-5753-6809
Suzhou Tel: +86-512-6592-0605 SEA Tel: +60-3-203-50737

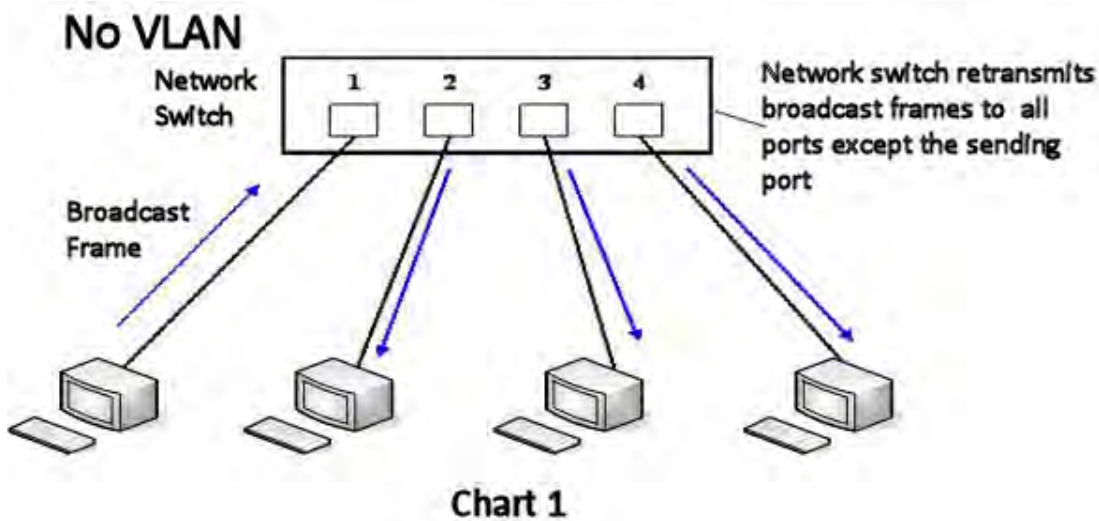

Chart 1 shows a network switch with no VLAN. Any broadcast frames will be transmitted to all other ports. For example, and frames broadcast from Port 1 will be sent to Ports 2, 3, and 4.

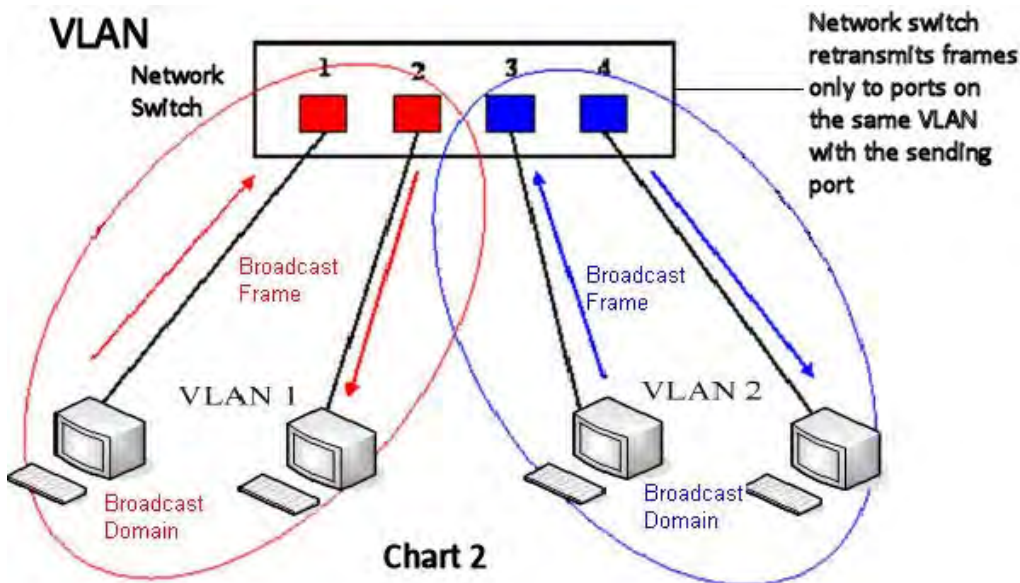

Chart 2 shows an example with two VLANs indicated by red and blue. In this example, frames broadcast from Port 1 will only go to Port 2 since Ports 3 and 4 are in a different VLAN. VLANs can be used to divide a network by restricting the transmission of broadcast frames.

Fanvil Technology Co., Ltd

HQ Add: Level 3, Block A, Gaoxingqi Building, Anhua Industrial Park, Qianjin 1 Road, 35th District, Bao'An, Shenzhen, 518101 P.R. China
 Tel: +86-755-2640-2199 Fax: +86-755-2640-2618 Email: fanvil@fanvil.com www.fanvil.com Beijing Tel: +86-10-5753-6809
 Suzhou Tel: +86-512-6592-0605 SEA Tel: +60-3-203-50737

Note: In practice, VLANs are distinguished by the use of VLAN IDs.

WAN	QoS&VLAN	SERVICE PORT	TIME&DATE
Quality of Service (QoS) Settings			
Enable DSCP	<input type="checkbox"/>	SIP DSCP	<input type="text" value="46"/> (0~63)
Audio RTP DSCP	<input type="text" value="46"/> (0~63)	Video RTP DSCP	<input type="text" value="46"/> (0~63)
WAN Port VLAN Settings			
Enable WAN Port VLAN	<input type="checkbox"/>	WAN Port VLAN ID	<input type="text" value="256"/> (0~4095)
802.1P Priority	<input type="text" value="0"/> (0~7)		
LAN Port VLAN Settings			
LAN Port VLAN Mode	<input type="text" value="Follow WAN"/>	LAN Port VLAN ID	<input type="text" value="254"/> (0~4095)
<input type="button" value="Apply"/>			

Service Port

WAN	QoS&VLAN	SERVICE PORT	TIME&DATE
Service Port Settings			
Web Server Type		<input type="text" value="HTTP"/>	
HTTP Server Port		<input type="text" value="80"/>	
HTTPS Server Port		<input type="text" value="443"/>	
RTP Port Range Start		<input type="text" value="10000"/>	
RTP Port Quantity		<input type="text" value="200"/>	
<input type="button" value="Apply"/>			

Fanvil Technology Co., Ltd

HQ Add: Level 3, Block A, Gaoxinqi Building, Anhua Industrial Park, Qianjin 1 Road, 35th District, Bao'An, Shenzhen, 518101 P.R. China
 Tel: +86-755-2640-2199 Fax: +86-755-2640-2618 Email: fanvil@fanvil.com www.fanvil.com Beijing Tel: +86-10-5753-6809
 Suzhou Tel: +86-512-6592-0605 SEA Tel: +60-3-203-50737

Field Name	Explanation
Web Server Type	Specify Web Server Type - HTTP or HTTPS
HTTP Port	Port for web browser access. Default value is 80. To enhance security, change this from the default. Setting this port to 0 will disable HTTP access. Example: The IP address is 192.168.1.70 and the port value is 8090, the accessing address is http://192.168.1.70:8090.
HTTPS Port	Port for HTTPS access. Before using https, an https authentication certification must be downloaded into the phone. Default value is 443. To enhance security, change this from the default.
RTP Port Range Start	Set the beginning value for RTP Ports. Ports are dynamically allocated.
RTP Port Quantity	Set the maximum quantity of RTP Ports. The default is 200.
<p>Notes:</p> <p>Any changes made on this page require a reboot to become active.</p> <p>It is suggested that changes to HTTP Port and Telnet ports be values greater than 1024. Values less than 1024 are reserved.</p> <p>If the HTTP port is set to 0, HTTP service will be disabled.</p>	

Fanvil Technology Co., Ltd

HQ Add: Level 3, Block A, Gaoxinqi Building, Anhua Industrial Park, Qianjin 1 Road, 35th District, Bao'An, Shenzhen, 518101 P.R. China
 Tel: +86-755-2640-2199 Fax: +86-755-2640-2618 Email: fanvil@fanvil.com www.fanvil.com Beijing Tel: +86-10-5753-6809
 Suzhou Tel: +86-512-6592-0605 SEA Tel: +60-3-203-50737

Registration

SIP Line: SIP 2

Basic Settings >>

Status	Registered	Domain Realm	
Server Address	172.16.1.2	Proxy Server Address	
Server Port	5060	Proxy Server Port	
Authentication User	2321	Proxy User	
Authentication Password	••••	Proxy Password	
SIP User	2321	Backup Proxy Server Address	
Display Name	Jasmine	Backup Proxy Server Port	5060
Enable Registration	<input checked="" type="checkbox"/>	Server Name	

Audio Codecs >>

Advanced SIP Settings >>>

Apply

Note: If the proxy configuration is same as the register configuration, in the web interface, the proxy fields are empty. While it is different with register configuration, the config info will display in the web interface. The backup proxy server will be used if the primary server is unavailable.

Set the audio codecs for current sip line.

SIP Line: SIP 2

Basic Settings >>

Audio Codecs >>

Disable codecs	Enable codecs
G.711U G.722 G.723.1 G.726-32 G.729AB AMR	G.711A

Advanced SIP Settings >>>

Apply

Fanvil Technology Co., Ltd

HQ Add: Level 3, Block A, Gaoxinqi Building, Anhua Industrial Park, Qianjin 1 Road, 35th District, Bao'An, Shenzhen, 518101 P.R. China
 Tel: +86-755-2640-2199 Fax: +86-755-2640-2618 Email: fanvil@fanvil.com www.fanvil.com Beijing Tel: +86-10-5753-6809
 Suzhou Tel: +86-512-6592-0605 SEA Tel: +60-3-203-50737

Dial Plan

Basic Settings

Basic Settings

- Press "#" to Send
- Send after second(s)(3~30)
- Press # to Do Blind Transfer
- Blind Transfer on Onhook
- Attended Transfer on Onhook
- Attended Transfer on Conference Onhook
- Dial Prefix
- Enable E.164

This phone supports 7 dialing modes:

1. Press # to Send – Dial the desired number, and press # to send it to the server.
2. Send after seconds – Number will be sent to the server after the specified time.
3. Press # to Do Blind Transfer - Press # after entering the target number for the transfer.

The phone will transfer the current call to the third party.

4. Blind Transfer on Onhook - Hang up after entering the target number for the transfer. The phone will transfer the current call to the third party.
5. Attended Transfer on Onhook - Hang up after the third party answers. The phone will transfer the current call to the third party.
6. Attended Transfer on Conference Onhook- Hang up during a 3-way conference call, the other two ways will make a call.

Fanvil Technology Co., Ltd

HQ Add: Level 3, Block A, Gaoxingqi Building, Anhua Industrial Park, Qianjin 1 Road, 35th District, Bao'An, Shenzhen, 518101 P.R. China
Tel: +86-755-2640-2199 Fax: +86-755-2640-2618 Email: fanvil@fanvil.com www.fanvil.com Beijing Tel: +86-10-5753-6809
Suzhou Tel: +86-512-6592-0605 SEA Tel: +60-3-203-50737

7. Dial Prefix- If you set the prefix is 135856, and you want to dial the number 13585679801. Then when you dial the number, you can press and hold 0, when the “+” appears, you can just input 79801 and send the number, the “+79801” is the number you input, but you can see the dialing number is 13585679801.

8. Enable E.164- You can refer to the E.164 standard.

Dial Plan Add

This feature allows the user to create rules to make dialing easier. There are several different options for dial rules. The examples below will show how this can be used.

Example 1: Substitution -- Assume that it is desired to place a direct IP call to IP address 172.168.2.208. Using this feature, 123 can be substituted for 172.168.2.208.

User-defined Dial Plan Table							
Digit Map	Call	Match To Send	Line	Alias Type:Number(length)	Suffix	Media	
"123"	Out	No	SIP(172.16.2.208:5060)			Default	

Example 2: Substitution -- To dial a long distance call to Beijing requires dialing area code 010 before the local phone number. Using this feature 1 can be substituted for 010. For example, to call 62213123 would only require dialing 162213123 instead of 01062213123.

User-defined Dial Plan Table							
Digit Map	Call	Match To Send	Line	Alias Type:Number(length)	Suffix	Media	
"1T"	Out	No	Default	rep:010(1)		Default	

Example 3: Addition -- Two examples are shown. In the first case, it is assumed that 0 must be dialed before any 11 digit number beginning with 13. In the second case, it is assumed that 0 must be dialed before any 11 digit number beginning with 135, 136, 137, 138, or 139. Two different special characters are used.

x -- Matches any single digit that is dialed.

Fanvil Technology Co., Ltd

HQ Add: Level 3, Block A, Gaoxingqi Building, Anhua Industrial Park, Qianjin 1 Road, 35th District, Bao'An, Shenzhen, 518101 P.R. China
 Tel: +86-755-2640-2199 Fax: +86-755-2640-2618 Email: fanvil@fanvil.com www.fanvil.com Beijing Tel: +86-10-5753-6809
 Suzhou Tel: +86-512-6592-0605 SEA Tel: +60-3-203-50737

[] -- Specifies a range of numbers to be matched. It may be a range, a list of ranges separated by commas, or a list of digits.

User-defined Dial Plan Table

Digit Map	Call	Match To Send	Line	Alias Type: Number(length)	Suffix	Media
"13[2-9]xxxxxxxx"	Out	Yes	Default	add:0		Default
"131xxxxxxxx"	Out	Yes	Default	add:0		Audio

Dial Plan Add

Digit Map:

Apply to Call: Match to Send: Media:

Line: Destination: Port:

Alias(Optional): Number: Length:

Suffix(Optional):

Fanvil Technology Co., Ltd

HQ Add: Level 3, Block A, Gaoxinqi Building, Anhua Industrial Park, Qianjin 1 Road, 35th District, Bao'An, Shenzhen, 518101 P.R. China
 Tel: +86-755-2640-2199 Fax: +86-755-2640-2618 Email: fanvil@fanvil.com www.fanvil.com Beijing Tel: +86-10-5753-6809
 Suzhou Tel: +86-512-6592-0605 SEA Tel: +60-3-203-50737

Field Name	Explanation
Phone number	<p>There are two types of matching: Full Matching or Prefix Matching.</p> <p>In Full matching, the entire phone number is entered and then mapped per the Dial Peer rules.</p> <p>In prefix matching, only part of the number is entered followed by T. The mapping with then take place whenever these digits are dialed. Prefix mode supports a maximum of 30 digits.</p>
Destination	Set Destination address. This is for IP direct.
Port	Set the Signaling port, the default is 5060.
Alias	Set the Alias. This is the text to be added, replaced, or deleted. It is optional.
<p>Note: There are four types of aliases.</p> <p>1) All: xxx - xxx will replace the phone number.</p> <p>2) Add: xxx - xxx will be dialed before any phone number.</p> <p>3) Delete: The characters will be deleted from the phone number.</p> <p>4) Replace: xxx - xxx will be substituted for the specified characters.</p>	
Suffix	Characters to be added at the end of the phone number. This is optional.
Delete Length	Sets the number of characters to be deleted. For example, if this is set to 3, the phone will delete the first 3 digits of the phone number. This is optional.

Fanvil Technology Co., Ltd

HQ Add: Level 3, Block A, Gaoxinqi Building, Anhua Industrial Park, Qianjin 1 Road, 35th District, Bao'An, Shenzhen, 518101 P.R. China
 Tel: +86-755-2640-2199 Fax: +86-755-2640-2618 Email: fanvil@fanvil.com www.fanvil.com Beijing Tel: +86-10-5753-6809
 Suzhou Tel: +86-512-6592-0605 SEA Tel: +60-3-203-50737

Security

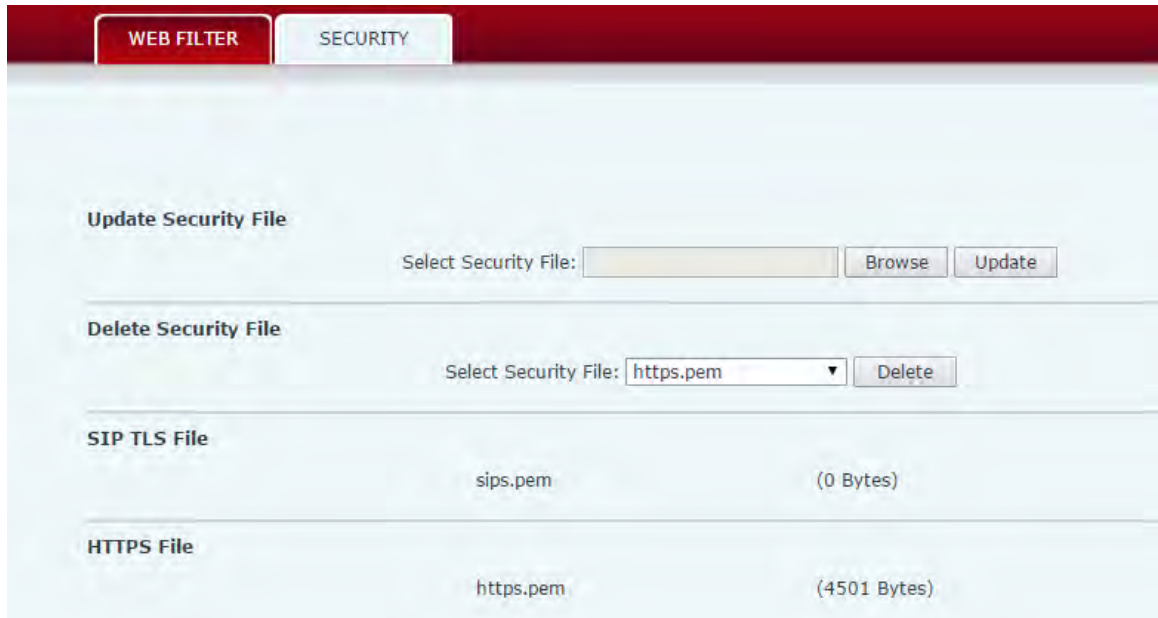

File Name	Size
sips.pem	(0 Bytes)
https.pem	(4501 Bytes)

Browse to the security file to be updated. Click the Update button to update.

Note: The sip TLS file and https file both support “xx.pem” format.

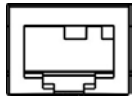

Internet interface

Specification RJ45, connect it to network.

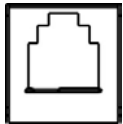

Handset interface

Specification RJ9, used to connect the Handset to the phone.



Interface illustration picture 2

Name

Meaning



USB interface.

Connect it to USB disk.

Fanvil Technology Co., Ltd

HQ Add: Level 3, Block A, Gaoxinqi Building, Anhua Industrial Park, Qianjin 1 Road, 35th District, Bao'An, Shenzhen, 518101 P.R. China
 Tel: +86-755-2640-2199 Fax: +86-755-2640-2618 Email: fanvil@fanvil.com www.fanvil.com Beijing Tel: +86-10-5753-6809
 Suzhou Tel: +86-512-6592-0605 SEA Tel: +60-3-203-50737

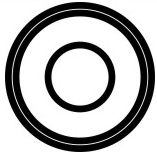

Headset interface.



Connect the Headset.
Headset standard: 3.5mm.



HDMI interface.

Interface for high-definition audio and video. A-A interface, A to A interface.

• **Note:**

1. Put the handset line into the handset interface according to the interface illustration.
2. Plug the power adapter into the DC port; poke the other side of the power adapter into an electric socket.
3. Insert one end of RJ45 network cable into the phone's WAN port (Please refer to the interface illustration picture 1) and put the other end into the network equipment. After that, if the network connection status on the status bar is displayed as , actions such as making some telephone calls and surfing the internet could be done. If the network connection status on the status bar is displayed as , please verify whether the network was configured correctly and the network cable was plugged in correctly.

Touch Screen Description

You can touch the screen manually to complete the corresponding operation. Here are three ways to use:

Click: Any icon or button can be clicked to realize its function.







Fanvil Technology Co., Ltd

HQ Add: Level 3, Block A, Gaoxinqi Building, Anhua Industrial Park, Qianjin 1 Road, 35th District, Bao'An, Shenzhen, 518101 P.R. China
Tel: +86-755-2640-2199 Fax: +86-755-2640-2618 Email: fanvil@fanvil.com www.fanvil.com Beijing Tel: +86-10-5753-6809
Suzhou Tel: +86-512-6592-0605 SEA Tel: +60-3-203-50737

Status Bar







All of the status information about D900 is displayed on the top of the screen. You can click on the notification icon in the left of the status bar or drag down the drop-down list with your fingers to enter the notification panel to further review and deal with all of the information.

Note:The right icon of the status bar can't be drag, just the left can.

Status bar	Meaning
 Handset mode	Indicates that the phone is in the handset mode.
 Headset mode	Indicates that the phone is in the headset mode.
 Silent mode	Shows that the phone is in silent mode. This mode can be canceled by directly clicking the mute button when the screen is in the idle interface.
 Hands-free mode	Indicates that the call is in hands-free status.
 Alarm clock	If you set an alarm clock, the alarm clock icon will display on the status bar.
 Network status (successful)	Displays that the network connection is successful. Tap the icon directly into the network settings.
 Network status (failed)	Shows that the network connected failed. You need to check the network is

Fanvil Technology Co., Ltd

HQ Add: Level 3, Block A, Gaoxingqi Building, Anhua Industrial Park, Qianjin 1 Road, 35th District, Bao'An, Shenzhen, 518101 P.R. China
 Tel: +86-755-2640-2199 Fax: +86-755-2640-2618 Email: fanvil@fanvil.com www.fanvil.com Beijing Tel: +86-10-5753-6809
 Suzhou Tel: +86-512-6592-0605 SEA Tel: +60-3-203-50737

		properly connected and the parameters are configured correctly.
	SD card	Displays that the phone successfully identifies the USB device. Tap the icon directly to switch into the USB application wizard.
	Missed calls	Shows that there are several missed calls. You can click on the icon directly to switch into the call log.
	Open the DND	Shows that the phone is on “Do Not Disturb” mode. Any of the call could be directly rejected before it’s ring interface appears. There is only a missed call icon leaving in the status bar.
	Call forward	Shows that the call forward function is opened.
	Auto answer	Shows that the auto answer function is opened.
	Black list	If a phone number is added to the firewall, then open the firewall function, all calls about this phone number could be rejected directly.
	New record	Indicates that there are several new

Fanvil Technology Co., Ltd

HQ Add: Level 3, Block A, Gaoxingqi Building, Anhua Industrial Park, Qianjin 1 Road, 35th District, Bao'An, Shenzhen, 518101 P.R. China
 Tel: +86-755-2640-2199 Fax: +86-755-2640-2618 Email: fanvil@fanvil.com www.fanvil.com Beijing Tel: +86-10-5753-6809
 Suzhou Tel: +86-512-6592-0605 SEA Tel: +60-3-203-50737

unread phone recordings.

Functional applications:



Phone

Click this icon, and it will switch to pre-dial interface. You can make some phone calls through the screen or keyboard.



Email

Has the function of sending and receiving e-mail. When an account has been configured successfully, you can send and receive your e-mail on the phone and this account will automatically sync the contacts to the mailbox account.



Settings

It contains System, Network, Account, Call, Display and so on. You can configure some settings.



Contacts

Support functions such as search, add, remove and edit.



Android settings

It contains the Call settings, Basic settings, Advanced settings, VOIP and so on, you can configure some settings in the corresponding menu. (Android system settings)



Message

Like the phone, with messages to write, read and send function.



MWI

All calls will be transferred into voice mail when the MWI is enabled.

Fanvil Technology Co., Ltd

HQ Add: Level 3, Block A, Gaoxinqi Building, Anhua Industrial Park, Qianjin 1 Road, 35th District, Bao'An, Shenzhen, 518101 P.R. China
Tel: +86-755-2640-2199 Fax: +86-755-2640-2618 Email: fanvil@fanvil.com www.fanvil.com Beijing Tel: +86-10-5753-6809
Suzhou Tel: +86-512-6592-0605 SEA Tel: +60-3-203-50737



Enter into the calendar and you can view the accurate date.

Calendar



Enter the call log and you can view all call records. You can also view the "Incoming Calls", "Outgoing Calls" and "Missed Calls" records by pressing the Option key.

Call log



Have export contacts, add blacklists and outgoing call barring functions.

Import and Export Management



Connect ppoe.

PPPOE

Update of the phone

Please contact with service provider to get the new version to upgrade.

Strongly recommended:

- 1) Before the upgrade the new version, please send personal data backup to mobile devices, to prevent accidental loss.
- 2) Once the upgrade process, please do not power blackout, equipment may not be able to start.

Auto provision: Keep phone registered successfully and configure parameters about automatic updates such as server address, upgrade file name, time interval and so on. And then the phone will check for updates from the server at a fixed time intervals and upgrade

Fanvil Technology Co., Ltd

HQ Add: Level 3, Block A, Gaoxingqi Building, Anhua Industrial Park, Qianjin 1 Road, 35th District, Bao'An, Shenzhen, 518101 P.R. China
Tel: +86-755-2640-2199 Fax: +86-755-2640-2618 Email: fanvil@fanvil.com www.fanvil.com Beijing Tel: +86-10-5753-6809
Suzhou Tel: +86-512-6592-0605 SEA Tel: +60-3-203-50737