

A31008-M1799-R101-2-7619

Issued by
Gigaset Communications GmbH
Schlavenhorst 66, D-46395 Bocholt
Gigaset Communications GmbH is a trademark licensee of Siemens AG

© Gigaset Communications GmbH 2008
All rights reserved.
Subject to availability. Rights of modifications reserved.

www.gigaset.com



Gigaset
HC450

Brief overview

With the Gigaset HC450, the door intercom becomes an integral component of the cordless telephone system. It supports two-way speech using any registered cordless telephone which means that the house telephone no longer has to be permanently located in the entrance area. The Gigaset HC450 door intercom is suitable for practically all single-family residences, including those that only have a bell.

Main features

- ◆ Two-way speech with callers to the door using the cordless telephone – including handsfree
- ◆ Intuitive operation via the handset's softkeys (open door, activate entry light)
- ◆ Easy configuration using the menu on the handset
- ◆ Forwarding to external numbers
- ◆ Ease of installation and registration with the Gigaset system
- ◆ Replacement of the old bell button with the door intercom – the existing cabling is generally adequate for installation
- ◆ Support for existing bell and standard door openers
- ◆ Configuration options for the second bell key (separate door call to specific handset, activation of entry lighting, same function as first bell key)

Gigaset Home Control

"Gigaset Home Control" is a standard that allows you to control

- ◆ household appliances
- ◆ lights and blinds
- ◆ alarm systems
- ◆ heating and air conditioning systems and
- ◆ door intercoms such as the Gigaset HC450

from a Gigaset cordless telephone.

The full functionality of the HC450 door intercom (opening the door from the handset, forwarding calls to an external number and configuring the system) is available in conjunction with Gigaset cordless telephones that support "Gigaset Home Control". A list of all compatible devices can be found in the appendix and on the Internet at www.gigaset.com/customer-care.

If you are operating the door intercom with a standard DECT handset that is not fully compatible and only supports the GAP standard, only the "intercom" function is possible.

(GDECT / GAP is the transmission protocol for cordless phones. This allows handsets of one manufacturer to be operated on the base station of a different manufacturer. In this case, however, operation is restricted to the telephones' basic functions.)

Brief overview

In common with the HC450 door intercom, all other products certified for "Gigaset Home Control" can be easily installed without additional cables and networked with the Gigaset cordless telephone at the push of a button. "Gigaset Home Control" thus grows with your needs.



All compatible devices feature the "Gigaset Home Control" logo, making them very easy to identify.

You will find more detailed and up-to-date information together with sources of supply for compatible products on the Internet at the following link:

www.gigaset-home-control.com

Range of applications

Assigning the two doorbell keys

The HC450 door intercom has two doorbell keys, each of which can be assigned different settings.

Top doorbell key:

The top doorbell key activates a connected external bell. At the same time, an internal call is initiated to a specific or to all handsets.

Bottom doorbell key:

- ◆ The bottom doorbell key can initiate another internal call (other handset or other ringer tone) in addition to the external bell.
- ◆ Its function can also be set identically to the top key or
- ◆ The entry lighting can be activated when the key is pressed. This requires the lighting system to be connected to the HC450 control unit. If the bottom doorbell key is being used as a "lights key", it cannot function as a "doorbell key".

Call diversion

If call diversion is activated for the door intercom, the door call will then be diverted to the external number. The call diversion relates to the top doorbell key. The call diversion can be controlled in different ways: If the occupier is at home he/she sets "**Status: Home**", which means that the internal handset will be called first. If no-one answers, the call will then be diverted. If "**Status: Away**" is set, the door call will immediately be forwarded to an external number.

Example:

In the Smith family's house, handset no. 1 rings when the top doorbell key labelled "Smith family" is pressed. Handset no. 2 belonging to the son will only ring when the bottom doorbell key labelled "Matthew Smith" is pressed. The Smith family has activated call diversion. If no-one from the family is at home, then the call will be forwarded to the father's mobile phone.

Door opener, bell and entry lighting

The following devices, which are not among the items supplied, can be connected to the HC450 and operated:

Door opener:

The door can be opened from the Gigaset handset or, in the case of a forwarded call, from a remote location. To do this, a standard door opener must be connected (not supplied). The voltage pulse (12 V alternating voltage) for opening the door is supplied by the HC450.

Bell: An existing bell will be connected to the HC450.

Door light:

A light circuit (e.g. the entry lighting) can be switched on from the handset and if applicable via the bottom bell key for between 1 and 90 seconds or also operated in pulse mode. The connection to the floating contact (230 V, 10 A) must be undertaken by a qualified electrician.

The illustration below shows the cabling with an existing doorbell (before) and the cabling following installation of the HC450 door intercom and HC450 control unit (after).

Before

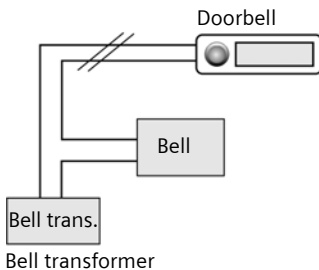

After

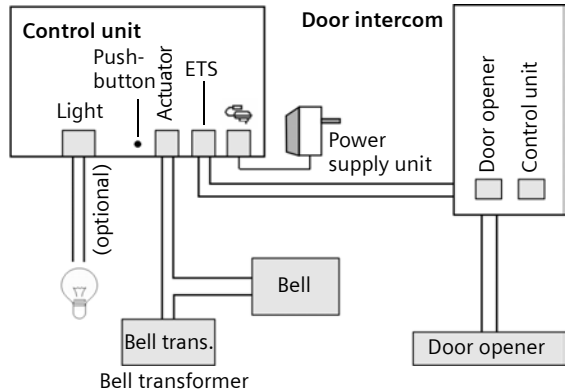

Contents

Brief overview	1
Gigaset Home Control	1
Range of applications	2
Safety precautions	5
Installing the Gigaset HC450 door intercom system	7
Pack contents	7
Mounting the HC450 door intercom	7
Mounting the HC450 control unit	9
Connecting the HC450 control unit	11
Setting up the Gigaset HC450 door intercom system	13
Registering with the base station	13
Setting functions	13
Operating the Gigaset HC450 door intercom using the handset	18
Incoming call from the door intercom	18
Calling the door intercom from an internal user	18
Operation with automatic call diversion	19
Menu tree	21
Appendix	23
Cleaning	23
Questions and answers	23
Gigaset cordless telephones compatible with the HC450	24
Service (Customer Care)	24
Authorisation	25
Guarantee Certificate United Kingdom	25
Guarantee Certificate Ireland	26
Technical Data	27
Index	28

Safety precautions

Caution:

Read the safety precautions and the manual before use.

Explain their contents to your children as well as the potential hazards associated with using the telephone.

- ◆ Only use the mains adapter supplied, as indicated on the underside of the control unit. **This adapter is only intended for use on the Gigaset HC450 and must not be connected to other devices.**

Make sure that the mains adapter is accessible at all times.

Do not continue to use broken plugs or plug-in power supply units with broken housings as they pose a risk of electric shock. Have these parts replaced with genuine spare parts without delay.

- ◆ The housing of the HC450 control unit and door intercom must not be opened. Unauthorised opening of the housing and improper repairs may endanger the user and will invalidate the warranty.
- ◆ The control unit is designed for indoor operation only. Lay the cables so that nobody can walk on or trip over them.
- ◆ The control unit includes a radio module in accordance with the DECT standard. The operation of medical appliances may be affected. Be aware of the technical conditions in your respective environment, e.g. doctor's surgery.
- ◆ The module must not be installed during a thunderstorm, nor should any cable connections be plugged in or unplugged, as to do so would expose you to the risk of electric shock.
- ◆ Do not allow fluids to penetrate the HC450 control unit and door intercom as this could result in electric shocks or short circuits.
- ◆ Do not use your telephone in environments with a potential explosion hazard, e.g. auto paint shops.
- ◆ If you give your Gigaset HC450 door intercom to someone else, make sure you also give them the manual.
- ◆ The entry light may only be installed by a qualified electrician. Please observe the respective national regulations for the installation of electrical and telecommunications systems.
- ◆ Only equipment supplying safety extra-low voltage (SELV) and complying with EN 60950 may be connected to the control unit (actuator output).

Safety precautions



All electrical and electronic products should be disposed of separately from the municipal waste stream via designated collection facilities appointed by the government or the local authorities.

This crossed-out wheeled bin symbol on the product means the product is covered by the European Directive 2002/96/EC.

The correct disposal and separate collection of your old appliance will help prevent potential negative consequences for the environment and human health. It is a precondition for reuse and recycling of used electrical and electronic equipment.

For more detailed information about disposal of your old appliance, please contact your city office, waste disposal service or the shop where you purchased the product.

Note:

Not all of the functions described in this manual are available in all countries.

Installing the Gigaset HC450 door intercom system

Installation of the HC450 door intercom system does not require additional cables to be laid if a doorbell with sound effect is already present. You replace the existing doorbell key in this case.

Begin by checking that you have all the components required for mounting.

Please read the entire chapter on installation carefully before you commence.

Pack contents

- ◆ 1 control unit with cover
- ◆ 4 plugs and mounting screws for fixing the control unit and door intercom
- ◆ 1 HC450 door intercom
- ◆ 1 frame for surface mounting
- ◆ 1 plug-in power supply unit
- ◆ 2 hexagon socket screws for fixing the door intercom to the frame
- ◆ 1 Allen key for the hexagon socket screws
- ◆ 2 clamping plugs for connecting the cables to the door intercom
- ◆ 2 doorbell key covers and nameplates
- ◆ 2 thermal shrinkage tubes

Mounting the HC450 door intercom

The HC450 door intercom generally replaces the existing doorbell. It is suitable for mounting outdoors and features weatherproof protection.

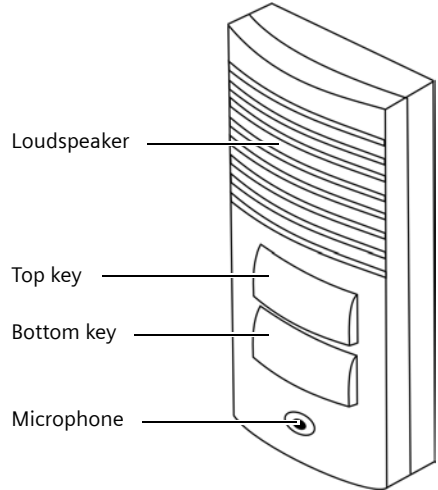

- ◆ Make sure that there are no power supply lines, cables or the like near the mounting location.
- ◆ Select the attachment and mounting location so that there is a minimum distance of 10 cm between the microphone and the closest wall surface.

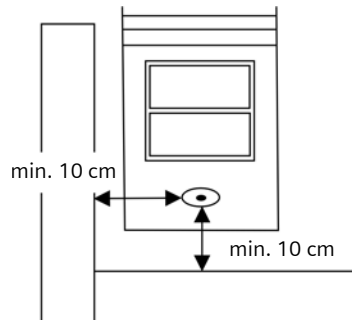

Surface mounting

- ◆ Remove the bell button if there is one and unscrew the cables. Fit the frame over the cable outlet. Next screw one of the enclosed green clamping plugs to the existing 2-core bell cable (polarity is not relevant here) and insert it in the jack with the ETS symbol (green jack).

Caution:

If you are using the existing bell cable, the doorbell system must be set to zero potential prior to installation.

Caution:

Cables must not be connected or disconnected during a thunderstorm.

- ◆ Hang the door intercom at the top of the frame (45 degree angle, see illustration on right) and lower it against the wall. Fix the door intercom using the two enclosed hexagon socket screws.

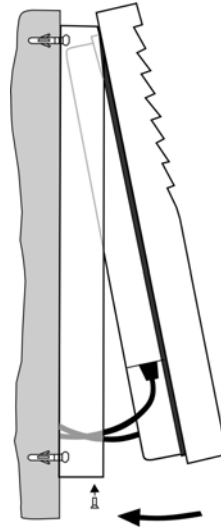

Connecting a door opener (optional)

The door opener is connected to the appropriate jack of the door intercom using a 2-core cable and the blue clamping plug.

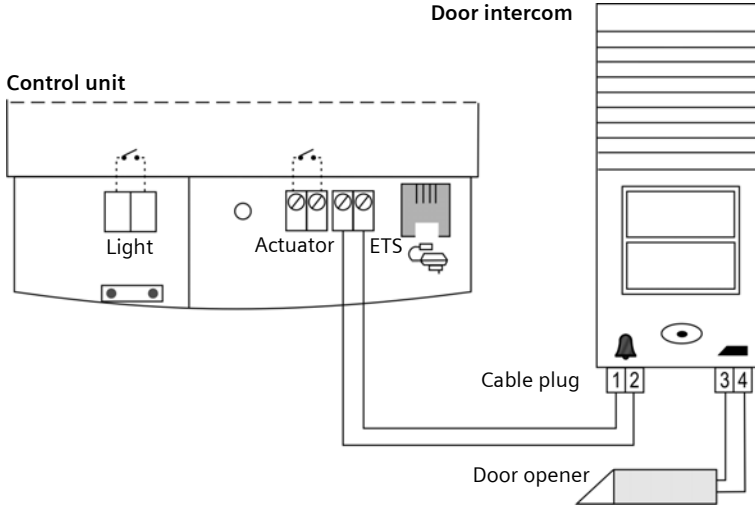

Labelling nameplates

- ◆ Label the enclosed nameplates using a waterproof pen. Insert them in the recesses in the doorbell keys.
- ◆ Position the doorbell key cover on the doorbell key from above and then apply gentle pressure at the top and bottom.
- ◆ Replacing nameplates: Insert a small screwdriver at an angle in the narrow notch on either side of the doorbell key cover. Carefully lever off the cover. Remove the nameplate.

Mounting the HC450 control unit

Requirements

The following requirements for mounting must be fulfilled:

- ◆ The HC450 control unit contains a DECT radio module. This module must be mounted within the base station's radio range (typically around 30 m indoors). Check the range using the handset before fixing the control unit. If a connection from a DECT handset to the DECT base station is possible at the designated location (field strength display shows at least one bar or a call of long duration is possible with satisfactory quality), you can mount the control unit here. If there is no connection to the base station at the designated mounting location, the range can be

Installing the Gigaset HC450 door intercom system

extended by means of a repeater placed between the base station and control unit.

- ◆ Mount the HC450 control unit at a suitable location along the junction wire between the bell button and bell. It is recommended that you mount the unit near the bell transformer. This is normally located in the fuse box. Any adjustment required to the fuse box must be undertaken by a qualified electrician.
- ◆ To ensure that a suitable mounting location is selected, familiarise yourself with the location of the cabling beforehand. Watch out for the cabling between the bell button, the bell transformer and the bell. Lay the cables so that nobody can walk on or trip over them. Before finally mounting the control unit, check the placement of the unit with temporary cabling by performing a function test (control unit can register with the base station, stable operation possible with adequate connection quality from the handset to the HC450 door intercom).
- ◆ You should also refer to the mounting instructions for the HC450 door intercom (see p. 7).
- ◆ The control unit must not be installed in a fuse box or metal housing.
- ◆ The control unit must not be installed near air conditioning systems, in areas with strong sunlight or in dusty environments.
- ◆ The control unit must be protected from the direct influence of water and chemicals.
- ◆ Areas with strong magnetic fields (transformers, electric motors, high-voltage lines) must be avoided.
- ◆ Cables must not be connected or disconnected or the HC450 control unit installed during a thunderstorm.
- ◆ Watch out for electrical, water or gas lines in the wall if mounting the control unit on the wall.

Mounting

If necessary, loosen the screws from the casing. Pull the cover downwards to remove it.

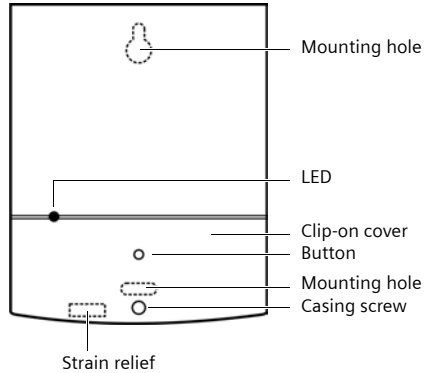

Mark the positions of the two drill holes on the wall. Drill two holes suitable for 6 mm wall plugs. Screw the upper screw into the wall plug and mount the casing by fixing the upper mounting hole onto the screw. Screw the casing into place using the lower mounting hole.

For laying the cables, a multi-core communications cable is recommended with a wire profile of 0.6 mm.

Connecting the HC450 control unit

Using existing cables

Disconnect the existing connection between the doorbell and the bell transformer/bell at an appropriate location, if possible near where the control unit is mounted (see next diagram on left).

Connect the open ends for the bell transformer/bell with the "Actuator" terminals in the control unit (polarity is not relevant).

Connect the open ends for the doorbell with the "ETS" terminals in the control unit (polarity is not relevant).

Caution:

Cables must not be connected or disconnected during a thunderstorm.

New cabling

Connect the 2-core cable of the door intercom to the terminals marked "ETS" in the control unit (see illustration below). Connect the bell transformer/bell to the "Actuator" terminals in the control unit.

Before

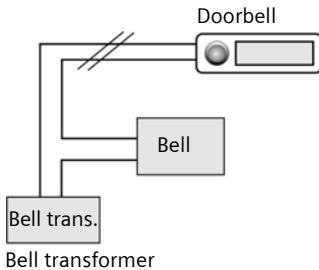

After

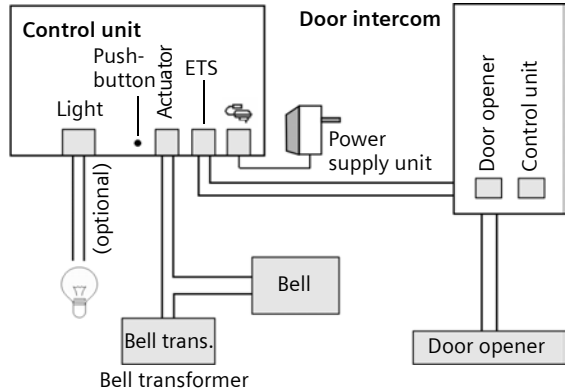

Connecting entry lighting

If you want to use the bottom doorbell key to switch on the entry lighting, the light source must be connected to the control unit using two cores (see illustration below). The entry lighting can also be switched on/off by means of a switch connected in parallel (see sketch, e.g. motion detector). Alternatively, a sensor input from a timing circuit can also be connected.

Caution:

The entry light may only be installed by a qualified electrician.
Stranded conductors must not be used for the connection and the insulation on the leads must not be stripped by more than 6 mm. The shrinkage tubes supplied must be pulled over the two wires (see diagram).
Secure the connection cable with the strain relief.

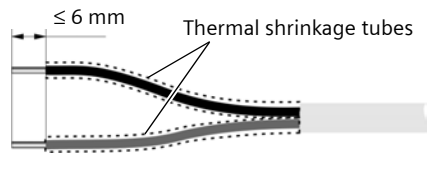

Connection with the power supply unit

Connect the mains adapter with the plug on the right-hand side of the control unit. Slide the cover back into the main casing. Screw the cover into place using the casing screw (see diagram p. 10).
Insert the plug-in power supply unit into a socket.

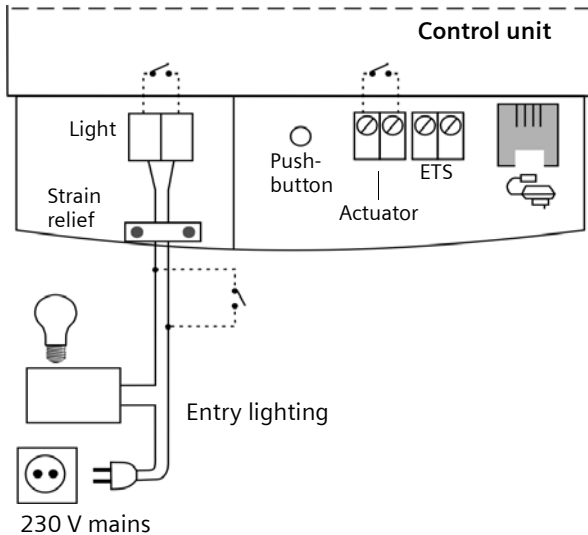

Setting up the Gigaset HC450 door intercom system

Once you have installed your HC450 door intercom system, you can set up the door intercom at your convenience using a compatible handset. Before you can do this, however, you must register the door intercom system with the base station.

Registering with the base station

Make sure that the control unit is connected to a power supply. If the LED on the HC450 control unit is flashing, it means that it is not yet connected with the base station.

- ◆ Set the 4-digit system PIN of your base station to "0000" if necessary (refer to the manual for your telephone).
- ◆ Press the registration/paging key on the base station for approx. 3 seconds. The registration/paging key is located on the right beside the charging cradle.
- ◆ Go over to the control unit and press the button on the control unit with a thin object such as a paper clip within 20 seconds (see illustration on p. 11). The LED on the control unit will light up continuously once it has been registered (the LED will return to flashing when a call is underway between the door intercom and base station). If registration does not take place despite a number of attempts, reduce the distance between the base station and control unit (the base station can be disconnected from the telephone network to do this) and/or briefly disconnect the control unit from the power supply before commencing registration.

- ◆ Following successful registration, "Intercom" will appear in the list of internal users. This preset name can be changed via the handsets (refer to the user guide for the handset).

Note:

Change the system PIN of the base station once more (refer to the manual for your telephone). This ensures, among other things, that only designated handsets can be registered with the base station.

Setting functions

Starting programming

Call up the menu for the door intercom settings. This initial programming step is always the same for all functions to be set.

Note:

The menu for changing the display language is called up automatically during startup (see p. 13).



Initiate an internal call and select the internal user "Intercom".



Press the talk key.



Press the display key.



Enter the 4-digit system PIN of the door intercom if the PIN has been changed from the delivery version (0000) and press **OK**.

You are now in the menu in which you can make settings for the door intercom.

Changing the display language

You can view the display texts in different languages. The languages available include English, German, Italian, Dutch and French.

Call up the menu for the settings (see p. 13):

Setting up the Gigaset HC450 door intercom system

 → **Language** → **OK**

The current setting is displayed.

English Select the desired language, for example "English" and press **OK**.

 Press and hold (return to idle status).

Changing the PIN of the door intercom

The door intercom allows you to assign a custom PIN to protect its settings against unauthorised access. You can change the 4-digit PIN (delivery version 0000) to a 4-digit PIN known only to you.

Call up the menu for the settings (see p. 13):

 → **Door PIN** → **OK**

 Enter a 4-digit PIN and press **OK**. The entry is saved.

 Press and hold (return to idle status).

Note:

To prevent misuse, we recommend assigning a separate PIN each for the door intercom and the base station.

The door can only be opened from an external telephone (see p. 19) by entering a separate PIN other than 0000 for the door intercom.

Making settings for the top doorbell key

You can set a specific internal call destination (handset) and ringer tone for the top doorbell key of the door intercom. You can also set the doorbell key to call all registered handsets.

Setting an internal call destination and ringer tone

Call up the menu for the settings (see p. 13):

 → **Upper Door Key** → **OK**

alternatively ...

 → **Internal Dest.** → **OK**

A list is displayed. It contains the entry "Call All" and the internal names of all registered handsets.

The current setting is displayed.

Select an internal user (e.g. "Anna") and confirm:

 → **Anna** → **OK**

If "Call All" is set, an incoming call from the door intercom will be forwarded to all internal users.

or ...

 → **Ringer Tone** → **OK**

The current setting is displayed.

 Select the desired ringer tone (call melody 1-6) or special "GHC melody".

Save Press the display key.

... continue with

 Press and hold (return to idle status).

Note:

If "Call All" is set and different handset types are being used, the call melodies of the individual handsets can differ.

Making settings for the bottom doorbell key

You have four options here:

1. **"As Upper Key" setting (as for first door call):** The function of the two keys is then identical.
2. **"Second Door Call":** You can select another internal user (and different tone dialling if necessary).

3. **"Light"**: You can use the doorbell key to control the entry lighting as an alternative to the "Door Call". The lighting system must be connected to the control unit for this purpose.

4. **"No Function"**.

Call up the menu for the settings (see p. 13):

  → Lower Door Key → **OK**

The current setting is displayed.

Select the mode for the bottom key: "Second Door Call", "Light" or "No Function".

Save Press the display key.

... continue with

 Press and hold (return to idle status).

Proceed as described in the section "Making settings for the top doorbell key" (see p. 14) to set the internal call destination and ringer tone.

The only difference is: In the menu for the door intercom settings select the entry "Low. Key Setting" instead of "Upper Door Key".

Setting up a call diversion to an external number

You can set up the call diversion using the following programming steps.

Caution:

Note that you can very easily activate or deactivate the call diversion from your handset. When you are at home, set the door intercom to "Status: Home". The incoming calls from the door intercom will then be sent to your internal handset. When you are leaving the house, set the door intercom to "Status: Away". The incoming calls will then immediately be routed to your external diversion destination. Refer to the chapter "Operation with automatic call diversion" (p. 19) to find out how to make the switch.

The external call diversion destination relates only to the top doorbell key.

Setting the destination for automatic call diversion to an external number

You can divert incoming calls from the door intercom to an external number. To do this, you must first enter the destination number.

Call up the menu for the settings (see p. 13).

  → Diversion No. → **OK**

 Enter the number (max. 20 characters) for the external call diversion and press **OK**. The setting is saved.

 Press and hold (return to idle status).

Caution:

Don't forget the zero for a trunk line if applicable.

If you do not enter a number for the external call forwarding, automatic call diversion to an external number will be switched off.

Activating/deactivating automatic call diversion to an external number

You can only activate the "Automatic Call Diversion" function if you have previously entered a diversion destination (see p. 15).

Call up the menu for the settings (see p. 13).

  → Diversion → **OK**

The current setting is displayed.

 Activate or deactivate automatic call diversion.

Save Press the display key.

... continue with

 Press and hold (return to idle status).

Setting the duration of the door light

The following settings can be selected: Pulse, 1, 2, 3, 10, 20, 30, 40, 50, 60, 70, 80 and 90 seconds.

Call up the menu for the settings (see p. 13):

 → **Timer** → **OK** → **Door Light** → **OK**

The current setting is displayed.

 Select the desired duration (pulse, 1 s, 2 s, 3 s, 10 s ... 90 s).

Save Press the display key.

... continue with

 Press and hold (return to idle status).

Setting the duration of the bell

You can set how long the bell at the door intercom should sound when the doorbell key is pressed. The following settings can be selected: pulse, 1, 2 or 3 seconds.

Call up the menu for the settings (see p. 13):

 → **Timer** → **OK** → **Door Bell** → **OK**

The current setting is displayed.

 Select the desired duration (pulse, 1, 2 or 3 s).

Save Press the display key.

... continue with

 Press and hold (return to idle status).

Setting the internal and external call time for incoming calls from the door intercom

You can set how long the handset should ring for an incoming call from the door intercom to an internal user and for a call diversion to an external user. The following settings can be selected: **no int. Ringing**, 10, 20, 30 or 60 seconds.

Call up the menu for the settings (see p. 13):

 → **Timer** → **OK**

alternatively ...

 → **Int. Door Call** → **OK**

or ...

 → **Ext. Door Call** → **OK**

The current setting is displayed.

 Select the desired time (**no int. Ringing**, 10, 20, 30 or 60 s).

Save Press the display key.

... continue with

 Press and hold (return to idle status).

Setting the external call duration for an incoming call from the door intercom

If a call diversion is set up to an external user, you can restrict the call duration for an incoming call from the door intercom. You can define how long a connection can last.

The following settings can be selected: 30, 60, 90 or 120 seconds.

Call up the menu for the settings (see p. 13):

 → **Timer** → **OK**
→ **Ext. Call Dur.** → **OK**

The current setting is displayed.

 Select the desired time (30, 60, 90 or 120 s).

Save Press the display key.

... continue with

 Press and hold (return to idle status).

Setting the volume of the external loudspeaker

You can set the volume of the external loudspeaker at the door intercom to nine different levels.

Call up the menu for the settings
(see p. 13):

 → **Volume** → **OK**

 Select the desired volume
for the external loudspeaker
(1-9).

Save Press the display key.

... continue with

 Press and hold (return to
idle status).

Note:

The voice connection between the handset and door intercom is activated during the setting process. This allows you to check the volume of the external loudspeaker directly.

Operating the Gigaset HC450 door intercom using the handset

Operation of the HC450 door intercom is largely identical for all handsets. It is described in this manual using the Gigaset S45 (high-feature handset). Some aspects of operation will differ between the standard handset and the high-feature handset.

Incoming call from the door intercom

When a call comes in from the door intercom (the bell will ring), either all handsets or just a specific handset will be called depending on the setting. If a call diversion from the door intercom is set up to an external number, the call will be diverted to the set number.

 Press the end call key to reject the call.

or ...

 Press the talk or loudspeaker key.

You are connected with the door intercom. "Intercom" appears in the display, alternatively ...

Op.Door Press the display key to activate the door opener. The door opener is activated.

or ...

Light Press the display key to switch on the entry lighting.

 Press the end call key.

Note:

The caller to the door can switch on the entry lighting, if set, using the bottom door key (see p. 12).

The following features are not available for an incoming call from the door intercom:

- ◆ Conducting a conversation
- ◆ Calling back from a conversation with the door intercom
- ◆ Toggling a caller at the door intercom
- ◆ Conducting a conference call with a user at the door intercom
- ◆ Diverting or forwarding an incoming call from the door intercom

Calling the door intercom from an internal user

You can call the door intercom internally and operate it even if the bell did not ring first. To do this, you must first select the internal user "Intercom" at the handset.

Select the internal user "Intercom".

 Open the list of internal users.

 → Intercom → 

 Press the display key.

 → Connect to Door → **OK**

alternatively...

Op.Door Press the display key to activate the door opener. The door opener is activated.

or ...

Light Press the display key to switch on the entry lighting.

or ...

 Press the end call key.

Operation with automatic call diversion



When a call is diverted, all the functions can also be used remotely from a mobile phone, for example to ask the postman to leave a parcel with a neighbour.

Switching between "Status: Home" and "Status: Away"

If you have entered an external number for call forwarding, you can switch between "Status: Home" and "Status: Away". The call diversion only ever relates to the top doorbell key.

- ◆ With "Status: Home", the defined internal user will be called when a call comes in from the door intercom. If the "Automatic Call Diversion" function is activated and the internal user does not answer the incoming call within the set time (see "Setting the internal and external call time for incoming calls from the door intercom", p. 16), the incoming call will be diverted to the defined external number.
- ◆ With "Status: Away", the call coming in from the door intercom will be diverted to the defined external number.

Calling the door intercom internally:

-  Initiate an internal call and select the internal user "Intercom".
- Edit** Press the display key if necessary to change the mode.
-  Press and hold (return to idle status).

Note:

The incoming call cannot be diverted to a further telephone if the external number is engaged when the call comes in from the door intercom or if an answering machine answers. The door intercom will not, however, be connected with the trunk line in this case.

Answering a diverted call at an external telephone

When you answer the call you will hear a recorded announcement that is repeated at regular intervals. You now have the option of accepting the call or terminating the process:

- 1 Press the **1** key to accept the call.
- #* Press the hash key #* to end the call.

The recorded announcement does not offer the option to open the door, however this option will be available to you if there is a door opener connected to your door intercom.

- 9 Press the **9** key to open the door.
-  Enter the 4-digit PIN.

Note:

It is only possible to open the door from an external telephone if a separate PIN other than 0000 has been set up beforehand for the door intercom (see p. 14).

Warning:

If you want to use the door opening function from outside, the front door cannot be locked. Please note the conditions of your insurance policy relating to break-ins.

If you enter the PIN correctly, you will hear a recorded announcement and the door will be opened. The voice connection will still be active; you can terminate it by pressing the hash key #*.

If you did not enter the PIN correctly, you will hear a recorded announcement: "Enter PIN". You can then either re-enter the PIN or re-establish the voice connection with the caller by pressing the star key *Δ. To terminate the voice connection, press the hash key #*.

If the conversation lasts longer than the set external call duration, a recorded announcement will sound 10 seconds

Operating the Gigaset HC450 door intercom using the handset

before the connection is due to be terminated. You can prolong the connection by pressing the 1 key.

If the set external call duration is exceeded once more, a recorded announcement will sound again 10 seconds before the connection is due to be terminated. The connection will be automatically terminated if you do not press the 1 key with approx. 5 seconds.

Terminating the process:

#* Press the hash key.

Note:

The door intercom automatically disconnects the line after the set time and thereby frees the line again.

Menu tree

In the **Settings** menu of the Gigaset HC450:

Connect to Door	(p. 18)		
Diversion No.	(p. 15)		
Diversion	(p. 15)		
Volume	Volume: 1 ... Volume: 9	(p. 17)	
Upper Door Key	Internal Dest.	Call All INT 1 ... INT 6	(p. 14) (p. 13)
	Ringer Tone	Melody 1 ... Melody 6 GHC-Melody **	(p. 14)
Lower Door Key	No Function	(p. 14)	
	As Upper Key		
	Second Door Call		
	Light		
Low. Key Setting *	Internal Dest.	Call All INT 1 ... INT 6	(p. 14) (p. 13)
	Ringer Tone	Melody 1 ... Melody 6 GHC-Melody **	(p. 14)
Language	Deutsch	(p. 13)	
	English		
	Francais		
	Italiano		
	Nederlands		
	Dansk		
	Suomi		
	Norsk		
	Svenska		
	Espanol		
Portugues			

*) This setting will only appear if the "Second Door Call" setting is activated in the "Upper Door Key" menu.

***) not available on all Gigaset phones

Menu tree

Timer	Door Light	impulse 1 second ... 90 second	(p. 16)
	Door Bell	impulse 1 second ... 3 second	(p. 16)
	Int. Door Call	no int. Ringing 10 second ... 60 second	(p. 16)
	Ext. Door Call	30 second ... 120 second	(p. 16)
	Ext. Call Dur.	30 second ... 120 second	(p. 16)

Appendix

Cleaning

- ▶ Wipe the HC450 door intercom with a **damp** cloth (do not use solvent) or an antistatic cloth.

Never use a dry cloth. This can cause static.

Questions and answers

If you have any queries about the use of your HC450 door intercom, contact us at www.qigaset.com/customer-care 24/7. The table below contains a list of common problems and possible solutions.

Control unit

No function

No power supply.

- ▶ Check the power supply.

Door opener not working

– no switching noise

Door opener is not correctly connected or does not conform to the specifications.

- ▶ Check the installation. Check whether the door opener is within the supported specification.

Door opener not working

– switching noise, but door not opening.

Door opener is not within the specification or not correctly installed mechanically.

- ▶ Check whether the door opener is within the supported specification or check the installation of the door opener (if necessary adjust).

HC450 door intercom

No function, no keys lighting up

No operating current.

- ▶ Check the installation, check whether the connections at the terminals are in the correct connection sequence.

Door intercom working (bell working), but not signalling at the mobile phones.

- Control unit is not registered with the base station (control unit LED flashing).
 - ▶ Register the control unit.
- Control unit has been registered but is dropping the connection (LED flashing).
 - ▶ Reduce the distance between the base station and the control unit. Install a repeater if necessary.

Bell not signalling at the mobile phones, even through the control unit has a connection to the base station (control unit LED lighting up continuously).

- no int. Ringing is set.**
 - ▶ Select a value between 10 and 60 seconds.
- Call forwarding activated (display showing "line in use").
 - ▶ Select "Status: Home".
- Handsets outside of range or switched off, specifically set handset deregistered or switched off.
 - ▶ Bring the handsets within the base station's range, switch on or charge the handsets.
 - ▶ Select another handset for signalling or switch over to "Signal to All Handsets".

If the problem cannot be rectified through the measures specified, you can reset the control unit's factory settings. To reset the factory settings, press the button on the control unit with a thin object such as a paper clip for 35 seconds (see diagram on p. 10).

Please note:

Any settings you have made will be lost when you reset the factory settings. You will have to reregister the control unit, see p. 13.

Gigaset cordless telephones compatible with the HC450

Compatible base stations

Gigaset SX440/SX445isdn
Gigaset SX450/SX450isdn
Gigaset E450/E455*
Gigaset E450 SIM/E455 SIM*
Gigaset S440/S445*
Gigaset S450/S455*
Gigaset S450 SIM/S455 SIM*
Gigaset S450 IP*
Gigaset S645
Gigaset SL440
Gigaset SL550/SL555*
Gigaset SL560/SL565*
Gigaset SL370/SL375*
Gigaset S670/S675*
Gigaset S675 IP*
Gigaset C470/C475*
Gigaset C470 IP/C475 IP*

Compatible high-feature handsets

Gigaset E45*
Gigaset S1/S1 colour
Gigaset S44
Gigaset S45*
Gigaset SL1/SL1 colour
Gigaset SL55*
Gigaset SL56*
Gigaset SL74
Gigaset SL37H*
Gigaset S67H*
Gigaset C47H*

*) These devices support the full "Gigaset Home Control" functionality and are marked with the "Gigaset Home Control" logo (not in all countries).

Service (Customer Care)

We offer you support that is fast and tailored to your specific needs!

Our Online Support on the Internet can be reached any time from anywhere. www.gigaset.com/customercare It provides you with 24/7 support for all our products. It also provides a list of FAQs and answers plus user guides and current software updates (if available for the product) for you to download.

You will also find frequently asked questions and answers in the appendix of this user guide.

For personal advice on our range of products and assistance with repairs or guarantee/warranty claims you can contact us on:

UK helpdesk: 0 84 53 67 08 12.

Ireland 18 50 77 72 77.

Please have your proof of purchase ready when calling with regard to guarantee/warranty claims.

Replacement or repair services are not offered in countries where our product is not sold by authorised dealers.

Authorisation

This device is intended for use within the European Economic Area and Switzerland. If used in other countries, it must first be approved nationally in the country in question.

Country-specific requirements have been taken into consideration.

We, Gigaset Communications GmbH *, declare that this device meets the essential requirements and other relevant regulations laid down in Directive 1999/5/EC.

A copy of the 1999/5/EC Declaration of Conformity is available at this Internet address:

www.gigaset.com/docs.

CE 0682

Guarantee Certificate United Kingdom

Without prejudice to any claim the user (customer) may have in relation to the dealer or retailer, the customer shall be granted a manufacturer's Guarantee under the conditions set out below:

- ◆ In the case of new devices and their components exhibiting defects resulting from manufacturing and/or material faults within 24 months of purchase, Gigaset Communications shall, at its own option and free of charge, either replace the device with another device reflecting the current state of the art, or repair the said device. In respect of parts subject to wear and tear (including but not limited to, batteries, keypads, casing), this warranty shall be valid for six months from the date of purchase.
- ◆ This Guarantee shall be invalid if the device defect is attributable to

improper treatment and/or failure to comply with information contained in the user guides.

- ◆ This Guarantee shall not apply to or extend to services performed by the authorised dealer or the customer themselves (e. g. installation, configuration, software downloads). User guides and any software supplied on a separate data medium shall be excluded from the Guarantee.
- ◆ The purchase receipt, together with the date of purchase, shall be required as evidence for invoking the Guarantee. Claims under the Guarantee must be submitted within two months of the Guarantee default becoming evident.
- ◆ Ownership of devices or components replaced by and returned to Gigaset Communications shall vest in Gigaset Communications.
- ◆ This Guarantee shall apply to new devices purchased in the European Union. For Products sold in the United Kingdom the Guarantee is issued by: Gigaset Communications GmbH, Schla-henhorst 66, D-46395 Bocholt, Germany.
- ◆ Any other claims resulting out of or in connection with the device shall be excluded from this Guarantee. Nothing in this Guarantee shall attempt to limit or exclude a Customers Statutory Rights, nor the manufacturer's liability for death or personal injury resulting from its negligence.
- ◆ The duration of the Guarantee shall not be extended by services rendered under the terms of the Guarantee.
- ◆ Insofar as no Guarantee default exists, Gigaset Communications reserves the right to charge the customer for replacement or repair.
- ◆ The above provisions does not imply a change in the burden of proof to the detriment of the customer.

To invoke this Guarantee, please contact the Gigaset Communications telephone

* Gigaset Communications GmbH is a trademark licensee of Siemens AG.

service. The relevant number is to be found in the accompanying user guide.

Guarantee Certificate Ireland

Without prejudice to any claim the user (customer) may have in relation to the dealer or retailer, the customer shall be granted a manufacturer's Guarantee under the conditions set out below:

- ◆ In the case of new devices and their components exhibiting defects resulting from manufacturing and/or material faults within 24 months of purchase, Gigaset Communications shall, at its own option and free of charge, either replace the device with another device reflecting the current state of the art, or repair the said device. In respect of parts subject to wear and tear (including but not limited to, batteries, keypads, casing), this warranty shall be valid for six months from the date of purchase.
- ◆ This Guarantee shall be invalid if the device defect is attributable to improper care or use and/or failure to comply with information contained in the user manuals. In particular claims under the Guarantee cannot be made if:
 - ◆ The device is opened (this is classed as third party intervention)
 - ◆ Repairs or other work done by persons not authorised by Gigaset Communications.
 - ◆ Components on the printed circuit board are manipulated
 - ◆ The software is manipulated
 - ◆ Defects or damage caused by dropping, breaking, lightning or ingress of moisture. This also applies if defects or damage was caused by mechanical, chemical, radio interference or thermal factors (e.g.: microwave, sauna etc.)
 - ◆ Devices fitted with accessories not authorised by Gigaset Communications

- ◆ This Guarantee shall not apply to or extend to services performed by the authorised dealer or the customer themselves (e.g. installation, configuration, software downloads). User manuals and any software supplied on a separate data medium shall be excluded from the Guarantee.
- ◆ The purchase receipt, together with the date of purchase, shall be required as evidence for invoking the Guarantee. Claims under the Guarantee must be submitted within two months of the Guarantee default becoming evident.
- ◆ Ownership of devices or components replaced by and returned to Gigaset Communications shall vest in Gigaset Communications.
- ◆ This Guarantee shall apply to new devices purchased in the European Union. For Products sold in the Republic of Ireland the Guarantee is issued by Gigaset Communications GmbH, Schla-venhorst 66, D-46395 Bocholt, Germany.
- ◆ Any other claims resulting out of or in connection with the device shall be excluded from this Guarantee. Nothing in this Guarantee shall attempt to limit or exclude a Customers Statutory Rights, nor the manufacturer's liability for death or personal injury resulting from its negligence.
- ◆ The duration of the Guarantee shall not be extended by services rendered under the terms of the Guarantee.
- ◆ Insofar as no Guarantee default exists, Gigaset Communications reserves the right to charge the customer for replacement or repair.
- ◆ The above provisions does not imply a change in the burden of proof to the detriment of the customer.

To invoke this Guarantee, please contact the Gigaset Communications helpdesk on 1850 777 277. This number is also to be found in the accompanying user guide.

Technical Data

HC450 control unit

RF standard	DECT
Range	Up to 300 m outdoors, Up to 50 m indoors
Number of channels	60 duplex channels
Radio frequency range	1880 –1900 MHz
Duplex procedure	Time multiplex, 10 ms frame length
Channel spacing	1728 kHz
Bit rate	1152 kbps
Modulation	GFSK
Voice coding	32 kbps
Transmit power	10 mW (average power per channel)
Operating temperature	0 °C to +40 °C
Storage temperature	-25 °C to +70 °C
Dimensions of the housing for surface mounting	185 x 150 x 30 mm (LxWxD)
Weight	1.1 kg with mains adapter
Protection class to DIN	IP40
Loading capacity of the switching contacts/relays	Actuator: max. 30 V, 1 A (30 VA) Light: 230 V, max. 5 A
Maximum conductor length between control unit and door intercom	without connected door opener: 100 m with connected door opener: – Ø 0.6 mm doorbell cable: up to 30 m – Ø 0.8 mm doorbell cable: up to 50 m
Colour	Grey

HC450 door intercom

Operating temperature	-20 °C to +55 °C
Storage temperature	-25 °C to +70 °C
Transport temperature	-25 °C to +55 °C
Dimensions	Door station cover: 215 x 98 x 30 mm (LxWxD) Frame for surface mounting: 210 x 93 mm (LxW)
Weight	360g
Moisture protection	IP53
Output voltage door opener	12 V AC, 1 A
Colour	Silver
LED colour of the keys	Yellow

Mains adapter

Operating voltage	230 V +/- 10%/50 Hz
Nominal power	max. 17 VA
Output voltages	12 V AC, 1 A 24 V AC, 0.2 A
Cable length	1.5 m

System

Power consumption	In idle state: approx. 4.5 W During operation: approx. 7 W
-------------------	---

Index

A

Actuator 11
 Authorisation 25

B

Base station 13
 Bell 3, 7, 10, 11, 16
 Bell transformer 10, 11
 Bottom doorbell key 14

C

Call diversion 2, 15, 18, 19
 activating/deactivating 15
 diversion destination 15
 operating the door intercom 19
 setting up to an external number 15
 status 19
 Call time 16
 Calling the door intercom from an
 internal user 18
 CE symbol 24
 Changing the display language 13
 Changing the PIN 14
 Clamping plug 8
 Cleaning 23
 Compatible
 Gigaset cordless telephones 24
 Connecting entry lighting 12
 Control unit 7, 13
 connecting 11
 connecting
 entry lighting 12
 LED 13
 light 12
 mounting 9
 radio range 9
 Customer Care 24

D

DECT 9
 DECT radio module 9
 Diversion destination 15
 Door intercom 13, 18
 accepting a call 19
 bottom doorbell key 14
 calling internally 18

 changing the display language 13
 changing the PIN 14
 clamping plug 8
 diversion destination 15
 duration of the bell 16
 external call duration 16
 for automatic call diversion,
 using 19
 incoming call from
 the door intercom 18
 labelling nameplates 9
 mounting 7
 operating using the handset 18
 range of applications 2
 registering with the base station 13
 second door call 14
 setting the call time 16
 setting up a call diversion
 to an external number 15
 supplied items 7
 surface mounting 8
 system PIN 13
 top doorbell key 14
 volume of the external
 loudspeaker 17
 Door light 16
 Door opener 3
 Door opener voltage 3
 Doorbell 7
 Doorbell key 2, 9, 14
 Duration of the bell 16
 Duration of the door light 16

E

Entry lighting 2
 External call duration 16
 External loudspeaker 17

F

Frame for surface mounting 8

G

GAP 1
 Gigaset Home Control 1
 Guarantee Certificate 25

H

Handset
 operating the door intercom 18

Home Control	1
I	
Incoming call from the door intercom	18
Installation	7
Internal and external call time	16
Internal conversation	18
Internal user "Intercom"	18
L	
Labelling nameplates	9
LED	13
Light	12
Lights key	2
M	
Mains adapter	5
Medical appliances	5
Menu overview	21
Mounting the control unit	9
Mounting the door intercom	7
N	
New cabling	11
P	
Pack contents	7
PIN	19
system PIN	13
Power supply unit	12
Q	
Questions and answers	23
R	
Radio range	9
Range of applications	2
Registration/paging key	13
Repeater	10

S	
Safety precautions	5
Second door call	14
Service	24
Setting the bottom key	14
Starting programming	13
Status away	19
home	19
Supplied items	7
Surface mounting	8
System PIN	13
T	
Technical data	27
Top doorbell key	14
Transformer	11
Troubleshooting	23
V	
Volume of the external loudspeaker	17